

THE KINGDOM OF CAMBODIA
PHNOM PENH CAPITAL CITY
MINISTRY OF PUBLIC WORKS AND TRANSPORT

THE PROJECT FOR COMPREHENSIVE URBAN TRANSPORT PLAN IN PHNOM PENH CAPITAL CITY (PPUTMP)

FINAL REPORT EXECUTIVE SUMMARY

December 2014

JAPAN INTERNATIONAL COOPERATION AGENCY (JICA)

METS RESEARCH & PLANNING, INC.
INTERNATIONAL DEVELOPMENT CENTER OF JAPAN, INC.
ORIENTAL CONSULTANTS CO., LTD.
TONICHI ENGINEERING CONSULTANTS, INC.

EI
JR
14-231

THE KINGDOM OF CAMBODIA
PHNOM PENH CAPITAL CITY
MINISTRY OF PUBLIC WORKS AND TRANSPORT

THE PROJECT FOR
COMPREHENSIVE
URBAN TRANSPORT PLAN IN
PHNOM PENH CAPITAL CITY
(PPUTMP)

FINAL REPORT
EXECUTIVE SUMMARY

December 2014

JAPAN INTERNATIONAL COOPERATION AGENCY (JICA)

METS RESEARCH & PLANNING, INC.
INTERNATIONAL DEVELOPMENT CENTER OF JAPAN, INC.
ORIENTAL CONSULTANTS CO., LTD.
TONICHI ENGINEERING CONSULTANTS, INC.

TABLE OF CONTENTS

	Page No.
CHAPTER 1 INTRODUCTION	1
1.1 Project Background	1
1.2 Project Objectives	1
1.3 Project Area	1
1.4 Project Framework	1
CHAPTER 2 EXISTING PROBLEMS AND ISSUES ON URBAN DEVELOPMENT AND URBAN TRANSPORTATION	3
2.1 Road Transport	3
2.2 Road Development	3
2.3 Mobility and Transportation Poor	4
2.4 Public Transport	4
2.5 Rapid Motorization	5
2.6 Traffic Management Measures	5
2.7 freight Transport	7
2.8 Urban Environment	7
2.9 Urban Transport-related Institutions	8
CHAPTER 3 SOCIO-ECONOMIC FRAMEWORK	10
3.1 Economic Framework	10
3.2 Population	10
3.3 Employment	11
3.4 School Enrolment	11
CHAPTER 4 URBAN VISION AND URBAN STRUCTURE	12
4.1 Urbanization and Land Use	12
4.2 Review of Previous Urban Plans	12
4.3 Future Urban Structure	13
CHAPTER 5 TRAFFIC DEMAND FORECAST	18
5.1 Traffic Demand Forecast	18
5.2 Freight Traffic Demand Forecast	23
CHAPTER 6 FORMULATION OF 2035 URBAN TRANSPORT MASTER PLAN	25
6.1 Goal, Mission and Target of the Master Plan	25
6.2 Development of the Master Plan Strategy	26
6.3 Master Plan Formulation	27

6.4 Planning Concept	28
6.5 Contents of the Urban Transport System	28
6.6 Urban Transport System Alternative	32
6.7 Evaluation of Alternatives	33
6.8 Proposed Concept of the 2035 Urban Transport Master Plan	34
6.9 Master Plan Components by Sector	35
6.10 Roadmap	36
CHAPTER 7 SECTOR PLAN.....	38
7.1 Public Transport System.....	38
7.2 Road Network	48
7.3 Traffic Management	55
7.4 Commodity Flow	70
7.5 Environmental and Social Considerations	72
7.6 Master Plan Long-List.....	75
CHAPTER 8 ORGANIZATION AND FINANCIAL CONSIDERATIONS.....	83
8.1 Proposed Organizations.....	83
8.2 Analysis on Financial Capacity	85
CHAPTER 9 IMPLEMENTATION PLAN	87
9.1 Introduction	87
9.2 Project Cost and Basic Considerations.....	87
9.3 Implementation Schedule.....	88
9.4 Overall Implementation Plan	88
9.5 Selection of Priority Programs	89
CHAPTER 10 ACTION PLAN.....	93
10.1 Introduction.....	93
10.2 Action Plan 1	93
10.3 Action Plan 2	94
CHAPTER 11 PRELIMINARY FEASIBILITY STUDY ON RAIL TRANSIT SYSTEM FOR EAST-WEST CORRIDOR	95
11.1 Introduction	95
11.2 Analysis and Screening on Target Public Transport Corridor	95
CHAPTER 12 CONCLUSION AND RECOMMENDATION	99
12.1 Conclusion.....	99
12.2 Recommendation.....	100

APPENDIXA-1

ABBREVIATIONS and ACRONYMS

AC	Advisory Committee
ADB	Asian Development Bank
AGT	Automated Guideway Transit
ASEAN	Association of Southeast Asian Nations
ATC	Area Traffic Control
BAU	Bureau of Urban Affairs
BOT	Build-Operate-Transfer
BRT	Bus Rapid Transit
BTS	Bus Transit System
CBD	Central Business District
CCTV	Closed Circuit Television
CDP	Corporate Development Partners
CINTRI	Canadian and Cambodian Joint Venture
CO	Carbon Monoxide
CO ₂	Carbon Dioxide
CP	Counterpart
DCC	Department of Climate Change, Ministry of Environment
DLMUPCC	Department of Land Management, Urban Planning, Construction and Cadastral
DLT	Department of Land Transport
DOE	Department of Environment
DOEPP	Department of Environment, Phnom Penh Capital City
DPWT	Department of Public Works and Transport
DWT	Deadweight Tonnage
EIA	Environmental Impact Assessment
EIRR	Economic Internal Rate of Return
EXIM	Export-Import
F/O	Flyover
F/S	Feasibility Study
GDP	Gross Domestic Product
GHG	Greenhouse Gas
GIS	Geographic Information System
GNP	Gross National Product
GPS	Global Positioning System

GRDP	Gross Regional Domestic Product
H/H	Household
HIS	Home Interview Survey
HIV/AIDS	Human Immunodeficiency Virus / Acquired Immunodeficiency Syndrome
ICD	Inland Container Depot
IMF	International Monetary Fund
IP	Internet Protocol
IPCC	Intergovernmental Panel on Climate Change
IRR	Inner Ring Road
IT	Information Technology
JICA	Japan International Cooperation Agency
JICA 2001MP	Urban Transport Master Plan in 2001
LIM	Linear Induction Metro
LRT	Light Rail Transit
M/B	Motorbike
MEF	Ministry of Economics and Finance
MLMUPC	Ministry of Land Management, Urban Planning & Construction
MOE	Ministry of Environment
MOEYS	Ministry of Education, Youth and Sports
MOP	Ministry of Planning
MP	Master Plan
MPP	Municipality of Phnom Penh
MPWT	Ministry of Public Works and Transport
MRD	Ministry of Rural Development
NGO	Non-Government Organization
NiDA	National Information Communications Technology Development Authority
NO ₂	Nitrogen Dioxide
NO _x	Nitrogen Oxide
NPV	Net Present Value
NR	National Road
NRSC	National Road Safety Committee
NSDP	National Strategic Development Plan
OD	Origin-Destination
PCD	Pollution Control Department
PCU	Passenger Car Unit
PDR	People's Democratic Republic
PIDP	Phnom Penh International Dry Port
PM	Particulate Matter
PMU	Project Management Unit
PPAP	Phnom Penh Autonomous Port
PPCC	Phnom Penh Capital City
PPCH	Phnom Penh City Hall

PPHPD	Passengers Per Hour Per Direction
PPIA	Phnom Penh International Airport
PPP	Public Private Partnership
PPSEZ	Phnom Penh Special Economic Zone
PPUTMP	Project for Comprehensive Urban Transport Plan in Phnom Penh Capital City
PPWSA	Phnom Penh Water Supply Authority
PT	Person Trip
PT-1	Public Transport Project No.1
PTMA	Public Transport Management Authority
PPUTA	Phnom Penh Urban Transport Authority
R/D	Record of Discussion
RGC	Royal Government of Cambodia
RT	Rail Transit
R/T	Rapid Transit
RR-II	Middle Ring Road
RR-III	Outer Ring Road
RR-IV	Outer-outer Ring Road
SC	Steering Committee
SEA	Strategic Environmental Assessment
SEZ	Special Economic Zone
SO ₂	Sulphur Dioxide
TAZs	Traffic Analysis Zones
TC	Technical Committee
TDM	Traffic Demand Management
TEU	Twenty-foot Equivalent Unit
THC	Total Hydrocarbon Compound
TOD	Transit Oriented Development
TRR	TOLL Royal Railway
VAT	Value Added Tax
V/C	Volume over Capacity
VMS	Variable Message Sign
W/T	Water Transport
2020MP	Phnom Penh Urban Planning Master Plan 2020

List of Figure

	Page No.
Figure 1.3-1 Project Area	2
Figure 1.4-1 Framework of the Project	2
Figure 2.1-1 Change in Travel Speed between 2001 & 2012.....	3
Figure 2.1-2 Current Traffic Conditions in the City Centre	3
Figure 2.4-1 Share of Phnom Penh International Airport Access Modes.....	4
Figure 2.6-1 Location of Problematic Intersections in Phnom Penh.....	5
Figure 2.6-2 Sidewalk Parking.....	6
Figure 2.6-3 Poor Pedestrian Walking Environment.....	7
Figure 2.7-1 Badly Damaged Trucking Route (Veng Sreng Road).....	8
Figure 3.2-1 Population Forecast in This Project in Relation to National Census and Other Studies.....	10
Figure 4.1-1 Current Urbanization Directions.....	12
Figure 4.2-1 Current Urbanized Area and Urban Area in 2020 MP.....	13
Figure 4.3-1 Phnom Penh Capital City in 2035.....	14
Figure 4.3-2 Urban Structure in 2020.....	16
Figure 4.3-3 Urban Structure in 2035.....	17
Figure 5.1-1 Travel Demand Forecasting Procedure.....	18
Figure 5.1-2 Change in Vehicle Ownership in the Future	19
Figure 5.1-3 Increase of Trip Production and Attraction.....	20
Figure 5.1-4 Growth of Trip Distribution.....	20
Figure 5.1-5 Modal Share by TAZ in the Future	21
Figure 5.1-6 Traffic Assigned on Network.....	23
Figure 6.1-1 Change of Urban Transport System between 2013 and 2035.....	26
Figure 6.4-1 How to Support the 2035 Urban Structure.....	28
Figure 6.5-1 Outline of the 2035 Road Network and Road Development Plan	29
Figure 6.5-2 Selected Public Transport Corridors	30
Figure 6.5-3 Concept of TDM.....	32
Figure 6.6-1 Outline of Proposed Urban Transport System Alternatives.....	32
Figure 6.8-1 Conceptual Picture of the Proposed 2035 Urban Transport Master Plan.....	35
Figure 6.10-1 Roadmap for Urban Transport Master Plan in PPCC	37
Figure 7.1-1 Concept of Public Transport Development with Change of Trip Modal Share ...	38
Figure 7.1-2 Staging Bus Route Network for Short to Medium Term	39
Figure 7.1-3 Concept of Bus Route Reorganization in Mid- and Long Term	40
Figure 7.1-4 Outline of Potential Public Transport Demand Estimation.....	42
Figure 7.1-5 Staging for Public Transport Network Development.....	45

Figure 7.1-6	Soi-bike in front of BTS Station in Bangkok.....	46
Figure 7.1-7	Conceptual Design of 3 Mode Interchange Areas	48
Figure 7.2-1	Transport Corridors to Promote Balanced	50
Figure 7.2-2	Road Projects Under Construction or in Committed Stage	51
Figure 7.2-3	Proposed Road Development Plan in the Central Area	52
Figure 7.2-4	Proposed Road Network in the Suburban Area	54
Figure 7.3-1	Conceptual Picture of Comprehensive Traffic Management System	55
Figure 7.3-2	Location of Major Problematic Intersections	56
Figure 7.3-3	Improved Signal Control Plan at Chamkar Morn Intersection	56
Figure 7.3-4	Proposed Improvement Measure at Chrouy Changvar Roundabout (Underground Passageway)	57
Figure 7.3-5	Basic Concept and Configuration of ATC System.....	58
Figure 7.3-6	Target Signalized Intersections for the proposed ATC System.....	58
Figure 7.3-7	Target Signalized Intersections for the installation of CCTV Cameras.....	58
Figure 7.3-8	Intersection Improvement Measures.....	59
Figure 7.3-9	Proposed One-Way Traffic System for Phnom Penh City Centre	61
Figure 7.3-10	Current Conditions of Pedestrian Network.....	64
Figure 7.3-11	Functions for Sidewalk by Section	65
Figure 7.3-12	Proposed Pedestrian Circumstance Improvement Plan along Street 240	66
Figure 7.3-13	Image Showing Target of TDM	68
Figure 7.5-1	Major Mitigation Measures of CO2 Emission.....	73
Figure 7.6-1	Location of Public Transport Projects in the Long-list.....	76
Figure 7.6-2	Proposed Road Projects in the Central Area.....	78
Figure 7.6-3	Proposed Road Projects in the Suburban Area	79
Figure 7.6-4	Location Map of Proposed Grade Separated Intersections.....	80
Figure 7.6-5	Location of Traffic Management Projects	82
Figure 10.2-1	Short- and Medium-term Schedule of the Action Plan 1	93
Figure 10.3-1	Short- and Medium-term Schedule of the Action Plan 2	94
Figure 11.2-1	Corridor Characteristics.....	96
Figure 11.2-2	Route Alternatives for East-West and Southwest Transport Corridors.....	96
Figure 11.2-3	Route Characteristics by Alternative	98
Figure 12.2-1	Recommended Responsibilities and Process of Merger between PTMA and PPUTA	102

List of Tables

	Page No.
Table 1.3-1	Population Trend.....2
Table 3.1-1	Forecast of Economic Framework.....10
Table 3.3-1	Employment Framework by Industry in 2012 to 2035.....11
Table 3.4-1	Student Framework.....11
Table 3.4-2	Socio Framework for the Project.....11
Table 5.1-1	Estimated Number of Trips Generated by Residents in 2035.....19
Table 5.1-2	Change of Modal Share21
Table 5.1-3	Performance Indicators by Assignment Case22
Table 6.5-1	What Kind of Public Transport System should be Introduced.....31
Table 6.7-1	Summary of Evaluation33
Table 6.7-2	Overall Evaluation34
Table 6.9-1	Master Plan Components by Sector.....36
Table 7.1-1	Population Covered by Bus Services.....39
Table 7.1-2	Classification of Urban Transport System.....40
Table 7.1-3	Latest Urban Transport Indicators in Selected Region in Japan41
Table 7.1-4	Estimation Result of Potential Mass Transit Demand in 203542
Table 7.1-5	System Selection based on Expected Demand Level43
Table 7.1-6	Comparison of Required Travel Time by Transport Mode and Trip Length43
Table 7.1-7	System Adaptability for Right-of-Way44
Table 7.2-1	Comparison of Traffic Demand and Traffic Capacity.....50
Table 7.3-1	System Implementation Schedule.....59
Table 7.3-2	Forecasted Motorcycle Parking Demand after Accounting for On-street Parking Provision.....62
Table 7.3-3	Forecasted Passenger Car Parking Demand after Accounting for On-street Parking Provision.....62
Table 7.3-4	Applicable TDM Measures for Phnom Penh.....69
Table 7.6-1	Outline of the Public Transport Projects in the Long-list75
Table 7.6-2	List of Road Project Packages77
Table 7.6-3	Traffic Management Projects in the Long-list81
Table 8.1-1	Outline of PPUTA (Tentative).....84
Table 8.2-1	Total cost in a short and medium term (2014-2020), Annual average cost, and Estimated annual budget by organization86
Table 9.4-1	Overall Implementation Plan89
Table 9.5-1	Selection of Priority Programs.....92
Table 11.2-1	Comparison of Evaluation for Route Alternatives.....97

1. INTRODUCTION

1.1 Project Background

Phnom Penh, Cambodia's capital city, has a population of about 1.85 million (as of 2012) and a land area of 678 km². Traffic conditions and traffic accidents in Phnom Penh have been worsening in recent years due to the rapid increase of vehicles mainly spurred by the country's vital economic growth. In order to address the serious traffic situation, the Japan International Cooperation Agency (JICA) conducted "The Urban Transport Master Plan in the Phnom Penh Metropolitan Area" (JICA 2001MP) with the target year of 2015. This was followed by "The Project for Traffic Improvement in Phnom Penh City" (March 2007-2010), in which JICA sought to promote the transfer of technologies for intersection improvement, traffic signal installation, and traffic safety to project counterpart in Phnom Penh. It is worth mentioning that road construction was completed earlier than planned in the JICA 2001MP.

Traffic congestions and traffic accidents, however, continued to increase due to the rapid increase of vehicular traffic and the lack of public transport, which did not materialized even though it was proposed by JICA 2001MP. A request was therefore made by the Cambodian Government to the Japanese Government for the conduct of the project to revise the JICA 2001MP and develop a comprehensive urban transport plan including action plans for solving transport problems. Thus, in October 2011, the detailed design study team for the "Project for Comprehensive Urban Transport Plan in Phnom Penh Capital City (PPTUMP)" was dispatched to Phnom Penh by JICA.

In consideration of the above projects that have already been conducted, PPUTMP's detailed design study team discussed the formulation of the urban transport master plan and related technology transfer with the counterpart team. Based on the items contained in the Record of Discussion (R/D) signed by both sides, PPUTMP was implemented from March 2012 to December 2014.

1.2 Project Objectives

The objectives of the Project were as follows: 1) to formulate a comprehensive urban transport plan targeting 2035; 2) to formulate the implementation plan of priority projects; and 3) to promote the transfer of technology to Cambodian counterparts through the Project in line with the R/D.

1.3 Project Area

The Project covered the whole administrative area of Phnom Penh Capital City, which encompasses 678 km² (refer to Table 1.3-1 and Figure 1.3-1).

1.4 Project Framework

The overall framework and composition of the Project is shown in Figure 1.4-1. It is basically divided into three phases in keeping with the submission of the Progress Report and Interim Report. Back-casting approach, stakeholder's participation and technology transfer to counterparts were also considered in the basic direction for the urban transport master planning.

Table 1.3-1 Population Trend

Name of Khan	1998	2008	2012
01 Chamkar Mon	187,082	182,004	184,200
02 DounPenh	131,913	126,550	119,500
03 Prampir Mea kakra	96,192	91,895	93,300
04 TuolKouk	154,968	171,200	186,100
01-04 Sub-total	570,155	571,649	583,100
05 Dangkao	48,921	73,287	96,100
06 PoSenChey	73,414	159,455	234,900
07 Mean Chey	97,190	194,636	282,700
08 Chhbar Ampov	108,796	133,165	160,500
09 Ruessei Kaev	76,473	115,740	152,600
10 Chrouy Changvar	53,231	68,708	84,000
11 Sen Sok	70,676	137,772	198,600
12 Preaek Phnov	34,574	47,313	59,700
05-12 Sub-total	563,275	930,076	1,269,100
Total	1,133,430	1,501,725	1,852,200
Area (KM2)	678		

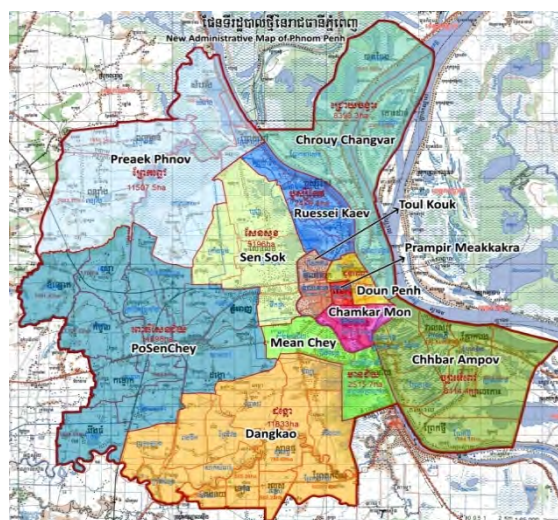

Source: Phnom Penh Capital City and PPUTMP Project Team

Figure 1.3-1 Project Area

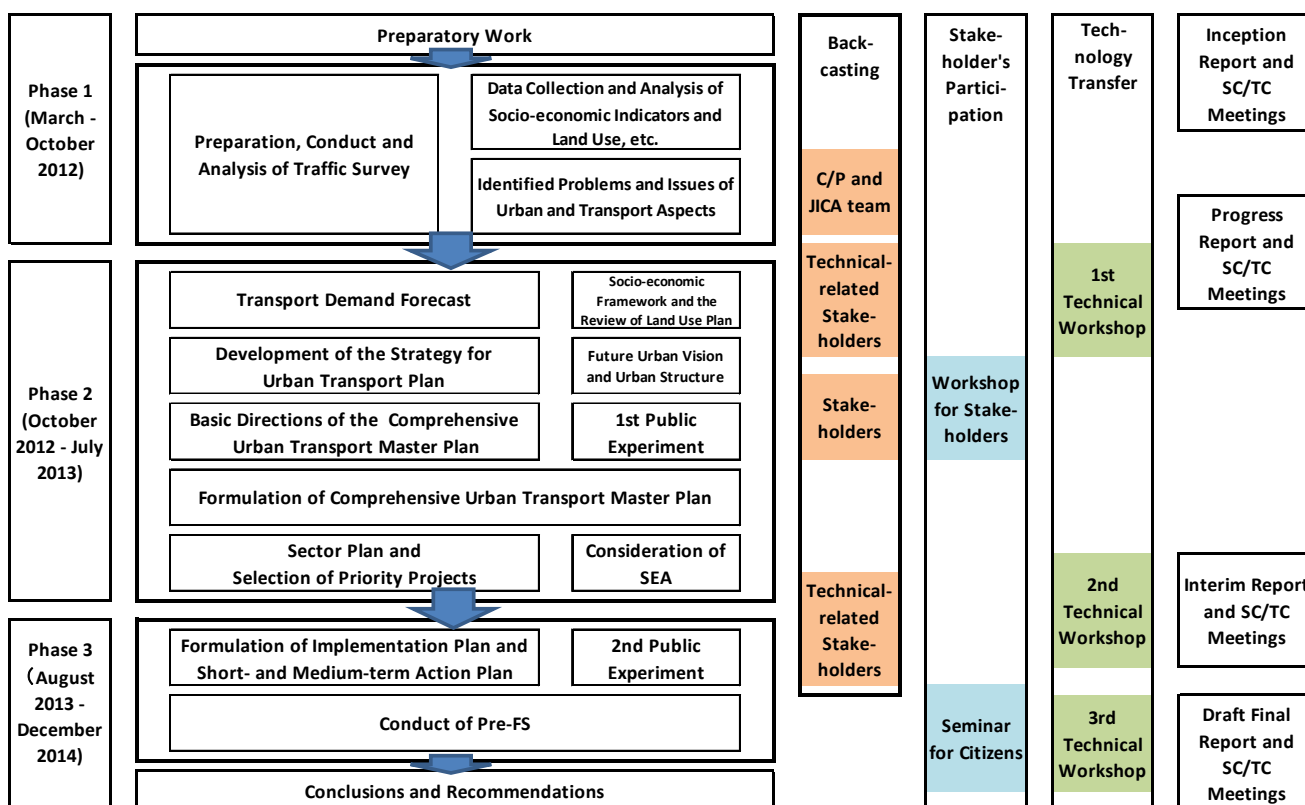

Note: SC: Steering Committee and TC: Technical Committee C/P: Counterpart
 Source: PPUTMP Project Team

Figure 1.4-1 Framework of the Project

2. EXISTING PROBLEMS AND ISSUES ON URBAN DEVELOPMENT AND URBAN TRANSPORTATION

Based on the Person Trip (PT) Survey and other data gathering activities and interviews on transportation conducted by urban transport-related agencies, the major urban and urban transportation problems and issues can be listed as shown below:

2.1 Road Transport

Traffic conditions on roads in the city centre deteriorate very rapidly such that, roads face serious space constraint while traffic demand increases exponentially.

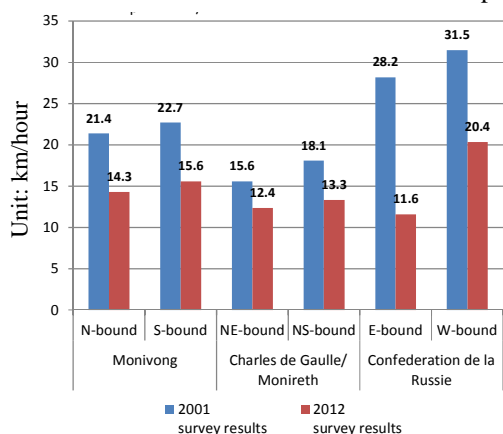

Source: PPUTMP Project Team

Figure 2.1-1 Change in Travel Speed between 2001 & 2012



Source: PPUTMP Project Team

Figure 2.1-2 Current Traffic Conditions in the City Center

2.2 Road Development

The continuity of several primary and secondary roads in the city is disrupted due mainly to geographical reasons such as presence of rivers and built-up areas (for example: no connectivity between St.360 and St.356, and St.608 and St.273).

Road density in the suburban areas is low (City centre: 12.2 km/sq. km and suburban area: 1.6 km/sq. km). Most of the existing secondary roads in these areas are not paved, making travels on such roads very difficult during the rainy season. Furthermore, widths of these roads are too narrow for the safe passage of two opposing vehicles.

Several major roads in the city have even 'zigzag' or 'L-shape' alignments, making them unsafe and incapable of supporting smooth traffic flows. Before the suburban areas are fully developed, it is very necessary to improve the alignment of these roads as well as identifying and developing alternative routes (for example, collector roads such as Krang Thnong Road and Kouk Roka Road in the north western segment between Hanoi Road and the ORR).

Many residential development projects are underway in the suburban areas. However, the capacity of trunk roads to accommodate the traffic to/from the access roads of these new development areas has not been considered. Thus, new traffic bottlenecks on those roads are likely to occur in the near future because of the rapid increase of vehicular traffic.

2.3 Mobility and Transportation Poor

Following the public experiment of the city bus in 2014 by JICA, PPCH and DPWT have taken over the management of city buses with 3 routes currently being operated. However, private passenger cars, motorcycles or para-transit modes such as Motodop are still main players as travel modes due to the limited bus route network and bus fleet. Hence the mobility of citizens is still low.

In the case of motorcycle users, many of them have to travel more than 20 km each trip. From the viewpoints of safety and comfort, this travel distance by motorbikes is below the standard of accessibility of a suitable transport.

From the results of the PT Survey conducted in Phnom Penh, the poor mobility of many citizens due to lack of convenient and comfortable public transport services was noted. Especially, this can be observed from the difference of trip rate between male (2.8) and female (2.3), and the age groups of 10 – 54 years old (2.7) and more than 55 years old (1.5).

Thus introducing a convenient and comfortable public transport mode including improving bus system becomes essential to those who do not have any means of transport, and even to those who may own a vehicle but not have driving license.

2.4 Public Transport

Even with the city bus system operating in 3 routes in PPCC, and except for the availability of para-transit such as Motodop and Motorumok Modern (tuk-tuk), there is no convenient and comfortable public transport mode in the city. The inter-city buses and their terminals are all located in the city centre. These buses are forced to travel on the narrow and congested city centre streets. In addition, their depots are often too small and there is no space for any expansion. It is therefore necessary to plan for a national road network system that links all the gateways to all the cities. To this end, there is a need to relocate such bus terminals to the suburban areas.

There are several ferry transport services in the city. However, access to the passenger jetties is chiefly by motorcycles, which is rather inefficient. An efficient, reliable and comfortable mode of transfer is very necessary. For this reason, public transport system should provide direct linkages to these ferry jetties.

Phnom Penh International Airport is the main gateway to Cambodia. Currently, access to the airport is via the relatively low capacity travel modes of passenger cars, taxis and para-transits. In view of the future growth of passengers (especially from the rapid increases in group tours), it is very necessary to begin preparing a public transport system that can provide efficient access to the airport with large travel capacity.

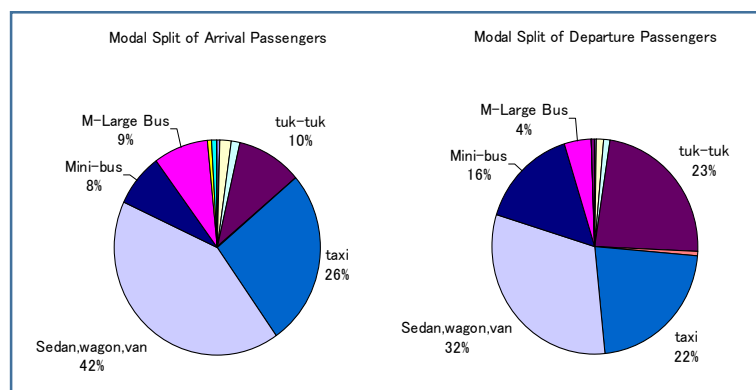

Source: PPUTMP Project Team

Figure 2.4-1 Share of Phnom Penh International Airport Access Modes

From year 2009, the railway operation in Cambodia has been undertaken and managed by the Toll Royal Railway (TRR), instead of Royal Railway of Cambodia (RRC) as a state enterprise.

The government of Cambodia has outsourced the railway operation under a 30-year exclusive concession for Toll (Cambodia) Co., Ltd. to operate the Cambodian railway network.

Its railway operation is envisaged for 2 main corridors, i.e., the south rail section which connects Phnom Penh (Samrong Station, 9km westward from the Central Station) and Sihanoukville with railway length of 284 km and the north rail section which connects Phnom Penh to Sisophon and then to Poipet (length of 386 km). A part of the north section from Sisophon to Poipet is not currently existing. Currently, only south railway section is operating as an inter-city freight transport.

2.5 Rapid Motorization

The number of registered light and heavy vehicles in PPCC has rapidly increased, from 4 thousand in 1990 to 268 thousand in 2012. And during the same period, the number of motorcycles has increased from 44 thousand to 951 thousand. The number of registered vehicles including motorcycles from 2001 to 2012 increased 3.46 times.

However, this number is an accumulation from 1990 and does not take into account the scrapped cars.

2.6 Traffic Management Measures

2.6.1 Major Problematic Intersections

The road network pattern in the city center is a combination of radial/ring pattern for trunk roads and grid pattern for secondary/local roads. Basically, many form a 4-leg intersection in the city center. There are, however, several intersections with more than four legs that were developed as roundabout during French colonial period and these intersections can be observed mainly these intersections are the ones that are mainly problematic. The 4-leg intersections, on the other hand, suffer from inadequate traffic signal phasing pattern. These intersections are shown in Figure 2.6-1 and describe below.

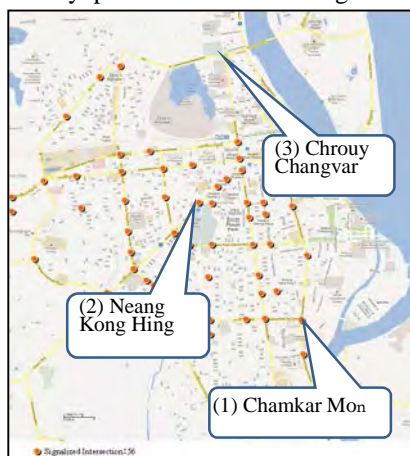

Source: PPUTMP Project Team

Figure 2.6-1 Location of Problematic Intersections in Phnom Penh

phasing pattern. These intersections are shown in Figure 2.6-1 and describe below.

The traffic control signal display at Chamkar Mom intersection is not capable of responding to the current traffic situations. At the same time, at Neang Kong Hing intersection, the signal display is complicated and difficult to understand. Congestion on St.182E is relatively outstanding.

Traffic volume at Chrouy Changvar Roundabout is heavy. Considering the expected future population and resulting increase in traffic demand, as well as the expansion of Japanese Bridge to 4 lanes which will inevitably attract more traffic, the loading at this roundabout will reach a high level in the near future.

2.6.2 Traffic Signal System

There are 69 signalized intersections in PPCC. Most of the existing signal are fixed time signal applying a single timing parameter set regardless of traffic condition, time of day, and day of the week. Therefore, traffic signals cannot maximize capacity of intersections, and most of intersections.

All signals in the city are isolated signals operating independently without coordination with neighboring signals. In the urban area where intersections are closely located and traffic volume is relatively high, this type of signal operation becomes inefficient.

A lack of understanding of this basic information indicates that management of traffic signal operation and maintenance is very poor and upgrading is needed.

2.6.3 Inefficient Road Usage Situations

Traffic congestions and the non-friendly pedestrian environment in the city are partly due to the



Source: PPUTMP Project Team

Figure 2.6-2 Sidewalk Parking

indiscriminate parking of cars and motorcycles at road shoulders and within intersections as well as multi-layer parking in front of famous restaurants and hotels and sidewalks.

Such haphazard ways of vehicle parking on the roadways and sidewalks are an eyesore to the urban landscape and detracts from the image of Phnom Penh as the capital city of Cambodia.

In recent years, car and motorcycle ownership rates have increased rather rapidly. This has put greater pressure on the present road network causing it to become more

congested and insufficient.

Sidewalks have become parking spaces; thus most pedestrians walk on the roadways putting their lives in danger. It is fair to say that there is no safe and conducive walking space or environment for pedestrians or tourists to move about safely and enjoy the cityscape. This is going to become one of the serious urban transport problems in the near future.

2.6.4 Neglect of Traffic Rules and Regulations by Drivers

The following are common offenses seen almost daily on the streets of Phnom Penh. Such behaviors have seriously affected the smooth flow of traffic and safety on the roads.

Along single carriageway roads, drivers would dangerously cross over the central line and travel against the opposing traffic on the other side of the road.

At intersections, motorcycles would stop in front of the stopping lines, occupying the entire pedestrian crossing spaces. At intersections where there are no medians, left turning motorcycles would cross over the central line and stop on the other side of the road. Where there are medians, motorcycles would intrude into the opposing direction and then forcefully make left turns by passing the other traffic in the intersection. This forces the opposing through-traffic stream to stop inside the intersection creating a huge traffic jam. During congested situations, motorcycles stopping in front of the through-traffic lanes would also make sharp left turns, creating very dangerous situations for other road users.

Other offenses include driving in the opposing direction on one-way streets, illegal parking (on roadways, sidewalks), driving without helmets and carrying more than the legal number of passengers allowed by law.

2.6.5 Severe Shortage of Parking Spaces

In the Central Business District (CBD), there is currently a shortage of 12,000 parking spaces for motorcycles and another 6,000 spaces for cars. As vehicle numbers increase rapidly, these shortages will become even more severe in the near future.

2.6.6 Poor Pedestrian Walking Environment

In sections of the city developed under the French colonial government, many areas have relatively wider sidewalks. However, such sidewalks are often taken over by illegally parked vehicles or cafes as their outdoor terraces, or for the display of merchandise by shops or as planter areas by residents. Pedestrians are thus forced to risk their lives walking on the roadways. As a result, for the tourists who move about mostly on foot in the city centre, the cityscape becomes less attractive. They also encounter walking difficulties on sidewalks that have very uneven surfaces.



Source: PPUTMP Project Team

Figure 2.6-3 Poor Pedestrian Walking Environment

2.6.7 Increase in Traffic Accidents

The rapid increases in car and motorcycle ownerships have brought about more congestions as well as traffic accidents. In Cambodia, number of fatalities by traffic accident in 2009 and in 2013 is 1,717 and 1894, respectively (Ministry of Interior (MOI)).

In the city of Phnom Penh, many accidents are found to have been caused by human error or unsafe behaviour such as drunk driving and speeding.

It is necessary to implement various measures in a collective manner, such as driver education and strengthening traffic law enforcement. Training of enforcement officers is also one of the measures that must be taken into consideration.

2.7 Freight Transport

The current freight transport problems in Phnom Penh are as follows:

The road surface along the trucking routes is badly damaged because of poor maintenance and management. As a result, trucks travel at low speed and safety level is not satisfactory.

Freight transport facilities are located in the heavily built-up areas of the city. Freight trucks have to mix with the general urban traffic. As a result, its service and safety level are adversely affected.

There are still some roads with narrow widths among the freight transport routes. Large and heavy trucks are thus forced to travel at very low speed.

There is also no sufficient space for loading and unloading of freights by the trucks. Trucks are forced to do so by the roadsides, causing severe interference to the traffic flows and creating hazardous situations for other road users.

From the viewpoints of the present region-wide freight transport nodes and future planning, the issues

facing freight transport and its terminal facilities are as follows:

- Veng Sreng Road is the only connecting road between NR 4 (Sihanoukville and Phnom Penh Special Economic Zone (PPSEZ)) and NR1 (New Phnom Penh Port). There is no alternative route.
- Urban development is rather intensive along Veng Sreng Road; hence, traffic conflict between heavy trucks and general daily traffic occurs.
- Region-wide freight traffic routes such as NR2, NR3, RR-II and Veng Sreng Road are basically two-lane roads. These are too narrow for serving the region-wide freight transport traffic which often involves heavy and huge trucks.



Source: PPUTMP Project Team

Figure 2.7-1 Badly Damaged Trucking Route (Veng Sreng Road)

2.8 Urban Environment

2.8.1 Natural Environment

The rapid urbanization of suburban areas has caused a rapid decline of green areas. Meanwhile, in the city centre, nature parks and green lungs are also decreasing, while emission of greenhouse gases such as the exhaust gases from vehicles is on the increase.

2.8.2 Social Environment

Traffic volumes in the city are increasing year after year causing a serious deterioration of the air quality and elevated levels of vibration in the urban areas.

There are still many factories located within the urban areas, and exhaust and other particulates emitted by vehicles coming in and out of these factories are also a major concern.

There are areas in the suburbs still without water supply simply because there are no roads leading to these areas.

Waste water and sewerage from the city are discharged into the Tra Bek Lake in the southern part of the city, then, discharge into the Tonle Sap River. However, this lake is basically serving as a 'flood control during rainy seasons'.

2.9 Urban Transport-related Institutions

Phnom Penh City Hall (PPCH) is responsible for all matters related to urban transport in the city and the introduction of public transport system. Considering these important roles, it is necessary to overcome its existing organizational problems or weaknesses.

The fundamental problems are as follows:

- 1) There is a lack of consensus among the related departments and agencies as to the measures and strategies to use in tackling urban transport issues;

- 2) A central command organization for the intensive management of urban transport problems is not clearly defined;
- 3) Policies to tackle traffic congestion problems are weak and hence not implemented; and
- 4) There is insufficient dialogue with urban transport operators and enterprises.

A Public Transportation Management Agency (PTMA) has just been set up in collaboration between PPCH and DPWT for the purpose of management and operation of city bus system. This agency has yet to acquire sufficient know-how and experience in managing the urban transport issues.

3. SOCIO-ECONOMIC FRAMEWORK

3.1 Economic Framework

Since there is no available data on the Gross Regional Domestic Product (GRDP) of Phnom Penh City area, the Project has to set an economic growth rate for the city based on the Cambodian National Economic Growth Trend.

By referring to the Rectangular Strategy, the National Strategic Development Plan (NSDP) updated 2009-2013 as well as the IMF Country Reports, the Cambodian National Economic growth rate for the planning target years after 2012 is set at 7.5% per annum.

This rate is in line with the economic growth rates as forecasted by the Cambodian Government and the International Monetary Fund (IMF) wherein the country is expected to grow at 6 to 7% per annum in the short and medium terms and 7% in the long terms.

Table 3.1-1 Forecast of Economic Framework

	2008	2012	2016	2020	2035
Real GDP Growth Rate (%)	6.7%	6.5%	7.5%	7.5%	7.5%

Source: PPUTMP Project Team

3.2 Population

The future population of Phnom Penh for 2016, 2020 and 2035 are forecasted in this study based on the population forecasts by the Ministry of Planning (MOP) in January 2011. However, the population forecasted by the Ministry of Planning was only confined to the old city area. In this study, the 2008 population census is also used to correct this shortcoming for estimating the future population of the city inclusive of the new city areas.

The population of Phnom Penh City at 2012 which is the base year in this study, is set at 1.85 million. The population for the medium-term target year of 2020 is forecasted at 2.41 million and for the final target year of 2035, 2.87 million.

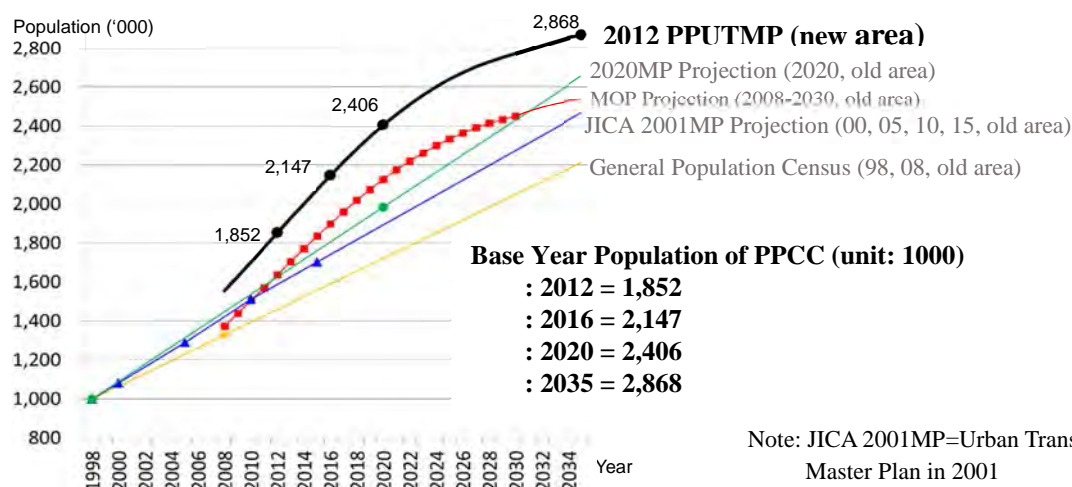

Source: PPUTMP Project Team

Figure 3.2-1 Population Forecast in This Project in Relation to National Census and Other Studies

3.3 Employment

The total employment in Phnom Penh city by industry by zone is forecasted based on the employment numbers by industry in the Cambodian National Census of 1998 and 2008, as well as the forecasted population by zone.

In the short-term target of 2016, the total employment in Phnom Penh is forecasted to be 1.05 million persons. This is expected to increase to 1.17 million in 2020 in the medium term and to 1.40 million in 2035 in the long term (final target year).

By industry, the primary industry is expected to employ 60,000 persons in 2016 in the short term, 55,000 in 2020 in the medium term and 40,000 in 2035 in the long term.

Employment in the secondary industry however is expected to employ 360,000 persons in 2016 in the short term, 400,000 in 2020 in the medium term and 490,000 in 2035 in the long term.

Finally, the tertiary industry is expected to employ 630,000 persons in 2016 in the short term, 715,000 in 2020 in the medium term and 870,000 in 2035 in the long term.

Table 3.3-1 Employment Framework by Industry in 2012 to 2035 (unit: in 1,000 person)

	2008		2012		2016		2020		2035		Difference 2035-2012
	No.	%	No.	%	No.	%	No.	%	No.	%	
Population	1,502	100.0%	1,852	100.0%	2,147	100.0%	2,406	100.0%	2,868	100.0%	+1016
Workforce	733	100.0%	900	100.0%	1,050	100.0%	1,170	100.0%	1,400	100.0%	+500
Primary	70	9.5%	65	7.2%	60	5.8%	55	4.8%	40	2.7%	-25
Secondary	240	32.7%	300	33.5%	360	34.1%	400	34.4%	490	35.2%	+190
Tertiary	423	57.7%	535	59.2%	630	60.1%	715	60.8%	870	62.0%	+335

Source: PPUTMP Project Team

3.4 School Enrolment

The future student population aged 6 to 17 by zone is forecasted based on the total population by zone estimated earlier. This age group corresponds to students in the elementary, middle and high schools. In addition, the school-going rates among students in this age group are set based on information obtained from the Ministry of Education, Youth and Sports (MOEYS) in its Education Strategic Plan 2009-2013. Using the above information, the student populations by zone and planning year are forecasted.

In the short term, student numbers are expected to grow to 252,000 persons by 2016, 369,000 persons by 2020 in the medium term and 436,000 persons by 2035 in the final target year.

Table 3.4-1 Student Framework (unit: person)

	2012	2016	2020	2035
Number	188,600	251,800	368,900	435,500

Source: PPUTMP Project Team

A summary of the above two forecasted framework indicators by the planning years shown in the table below.

Table 3.4-2 Socio-economic Framework for the Project (unit: 1,000 person)

	2008	2012	2016	2020	2035
Population	1,502	1,852	2,147	2,406	2,868
Employment	733	900	1,050	1,170	1,400
Primary	70	65	60	55	40
Secondary	240	300	360	400	490
Tertiary	423	535	630	715	870
Students	—	189	252	369	436

Source: PPUTMP Project Team

4. URBAN VISION AND URBAN STRUCTURE

4.1 Urbanization and Land Use

The current urban expansion of Phnom Penh Capital City (PPCC) is conceptually indicated in Figure 4.1-1. As shown in the figure, the urban area of Phnom Penh expands to the west, north and south directions along the NR No.4, No.5 and No.1, respectively. The radius of urban area in the west direction reaches around 10 km, in the south direction, around 5 km and in the north direction, around 2 km.

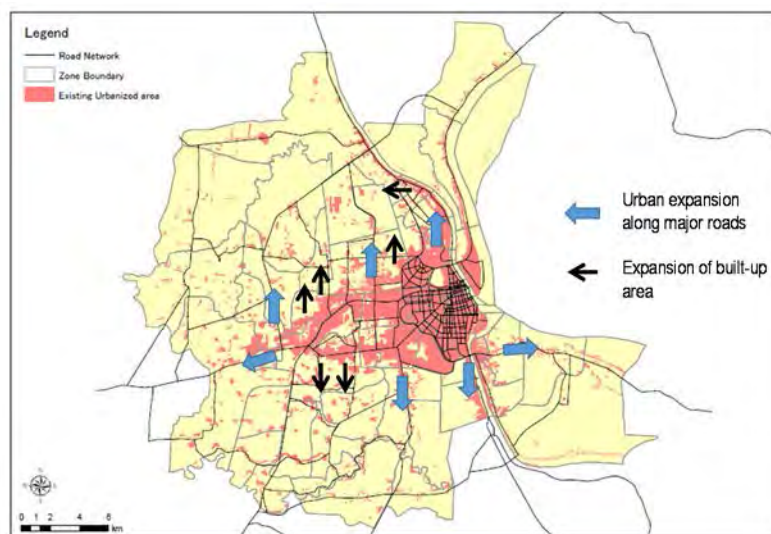

Source: PPUMTP Project Team

Figure 4.1-1 Current Urbanization Directions

Urban central functions including administration, banking, business and commerce are concentrated in the areas in Sangkat of 7 Makara, Daun Penh along Monivong Road, which is a highly dense area. The surrounding area of the central area up to the inner ring road (IRR) has mid-level population density and is used as residential area. In the area between IRR and the middle ring road (RR-II), urban areas are formed along the major arterial roads with shop-houses, but there are still much vacant lands behind, so that the population density is still low as a whole. The suburban area, located in the outskirts of RR-II, is not so much urbanized, but there are many factories located in the west direction.

The current urban expansion could be understood by dividing the movement into two: One is urban expansion along the major roads wherein the urbanized area expands to the west, north and south directions along the national road No.4, No.5 and No.1, respectively. The other is expansion of built-up areas wherein existing urbanized areas expand to the areas behind, in particular the area in the west direction.

4.2 Review of Previous Urban Plans

There is an urban master plan for PPCC; namely, “White Book on Development and Planning of PPCC” (hereinafter referred to as “2020MP”) prepared by a French consultant team under French assistance, which was completed in 2009. The plan delineates land use and urban facilities that sets 2020 as the target year. As the 2020 framework of urban planning, the plan applies 1.98 million persons as population and

designates approximately 220 ha of urban areas. The PPUTMP Project Team assessed 2020MP from the viewpoint of current urbanization process, current population growth, private sector development and road network as follows:

- Currently urbanizing area is in the area designated as urban area of 2020MP (refer to Figure 4.2-1).
- The designated urban area in the 2020MP is relatively wide considering the planned future population framework of 2.4 million persons.
- Current road system is planned to conform to a radial and circular pattern, requiring some transport network proposed in the master plan to be up-dated.
- Several large-scale private urban development projects are on-going or planned outside of the urban area designated in the master plan (gray colored are in Figure 4.2-1).

Since the 2020MP is authorized by PPCC and is now under authorization process in the national level, it is reasonable to follow the current master plan with minimum modification taking into consideration the above assessment.

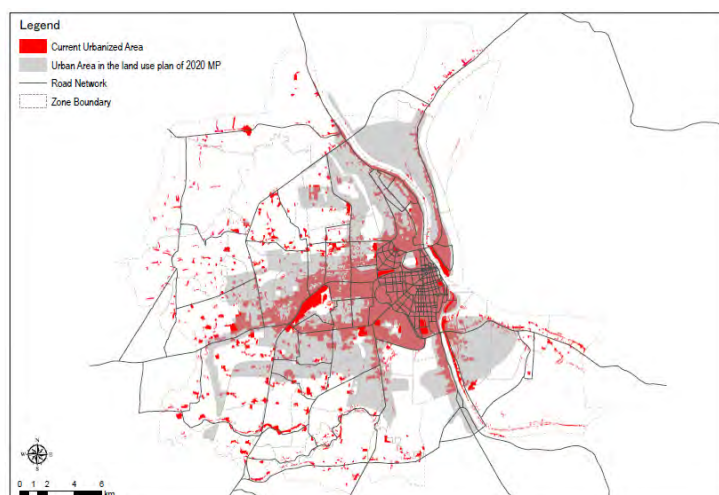

Note: The area with gray color shows urban area in the master plan, while the area with red color shows current urbanized area.

Source: PPUTMP Project Team

Figure 4.2-1 Current Urbanized Area and Urban Area in 2020 MP

4.3 Future Urban Structure

4.3.1 Urban Vision

PPCC is required to keep the position as a driving force in Cambodia's economic development by utilizing its strategic location relative to three cross points, namely, 1) historical river cross point (Mekong/Tonle Sap/Tonle Basac), 2) Asian Highway cross point (Indochina Southern Corridor/Central Corridor/Growth Corridor) and 3) regional industrial cross point (Sihanouk Ville Port/New Phnom Penh Port/Kampong Chhunang New Airport/Agro-industrial Zone in the Mekong River East Bank), to accumulate more economic activities. On the other hand, PPCC is the largest city in Cambodia with a 1.85 million population. Urbanization is rapidly proceeding; its urban area is expanding; high-rise buildings are constructed in downtown area; and traffic congestion often observed due to increase of cars and motorcycles, with severity

depending upon population increase and economic growth. These problems would be more serious with more economic activities and population increase, making it increasingly necessary for PPCC to take steps to solve/mitigate such urban problems.

The above understanding is shared by many stakeholders. At a workshop, they pointed out the necessity of improving the physical functions of PPCC, to be a more sophisticated city with high mobility and IT and to lead Cambodia to be a more modern society. Environmental friendliness is also an aspect given great attention by the stakeholders. The PPUTMP Project Team listened closely to the opinions of the stakeholders and finally drew up the following vision statement that best reflects their sentiments:

Phnom Penh – Smart, Mid-Mekong Capital City - is the Economic Hub and Center of Population in Cambodia, People Friendly and Environment Friendly

This urban vision of PPCC implies the following basic framework of future urban development as well as urban structure:

Vital Urban Activities Created by Young Population

High Mobility and Convenience Transportation

Proximity of Living and Working Place: New Urban Living and Flexible Working Style

Rich and Comfortable Urban Environment and Eco-friendly Suburban Environment

PHNOM PENH CAPITAL CITY IN 2035



Source: PPUTMP Project Team

Figure 4.3-1 Phnom Penh Capital City in 2035

4.3.2 Preconditions

The following five points should be taken into account for examining the future urban structure of PPCC:

1. The population of PPCC will increase to 2.4 million in 2020 and 2.8 million in 2035. Total employment will increase to 1.2 million persons in 2020 and to 1.4 million in 2035 in accordance with the population increase. (Population in 2008 is 1.5 million persons and the total employment is 0.7 million persons.)
2. To accommodate future population, PPCC will have to develop 5,540 ha of land between the years

2020 and 2012, and 4,620 ha of land between the years 2020 to 2035.

3. It is necessary to take into account the current 8 major urban development projects being in implemented by the private sector.
4. It is necessary to ensure that overall consistency with 2020MP, which is under authorization process, is preserved.
5. There should be conformity with large transport projects such as Sihanouk Ville Port, the new Phnom Penh Port and the planned new international airport.

4.3.3 Urban Structure in 2020

(1) Urban Area

Since the PPUTMP Project Team confirmed that the current urbanization basically meets the land use plan in the 2020MP, the Team has adopted the concept of land use plan in the 2020MP, considering a new population framework.

Urban expansion continues following the direction of current urbanization, which is along major roads, the expansion of built-up areas to the areas behind from road side, and large-scale private urban development (residential complex development) projects.

(2) Land Use and Density

Illustrated in Figure 4.3-2, land use and density can be described as follows.

Inside of IRR: high and mid-density mixed land use

Outside of IRR: mid-density at private development areas and the area along NR4, the other area low density

Industrial areas along Veng Sreng Road, NR4 and RR-III

Other: Green and farm land, water body, vacant land etc.

(3) Urban Centers

In Figure 4.3-2, urban centers composed of follows.

Urban Center (Boueng Kok, Monivong, Diamond City)

Eight (8) Sub-centers (Chbar Ampov, Kandal, Grand Phnom Penh, Camko City)

Production Center (Chaom Chau, RR-III)

(4) Transport Network

Major transport Node: Phnom Penh International Airport
Phnom Penh Port,
New Phnom Penh Port

Major transport Corridor: North-South Transport Corridor including 3 sub-corridors supports the urban institutional, business and commercial activities
East-West Transport Corridor including 3 sub-corridors supports the urban industrial and commodity activities
Ring Transport Corridor (Grand Phnom Penh - Stueng Mean Chey) supports the urban connectivity

Regional Corridor: Growth Corridor and Indochina Central Corridor: Sihanoukville - NR4 -

PPCC - NR6

Indochina Southern Corridor: NR1 - PPCC - NR5

Mode Interchange Area: Both ends and intersection of major transport corridors

The planned urbanized area in 2020MP is relatively wider because of the adoption of lower population densities. The planned future urbanized area in this project aims at a compact development considering the current urbanization and population density configuration. Therefore, urbanization to the southern area in the urban structure is suppressed unlike that in the 2020MP. The abovementioned urban structure is conceptually illustrated in Figure 4.3-2.

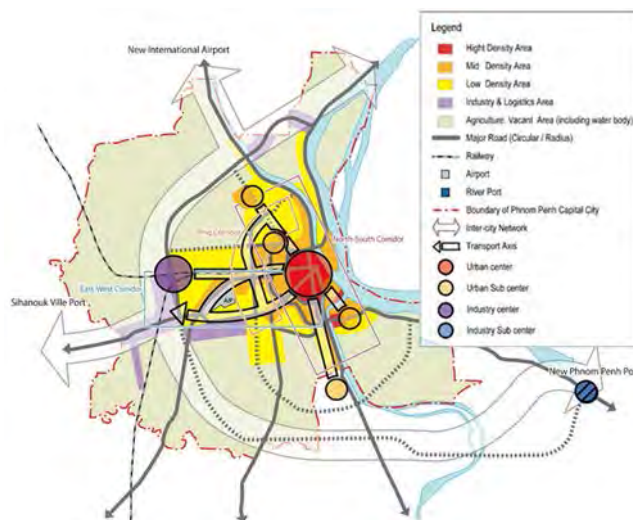

Source: PPUTMP Project Team
Figure 4.3-2 Urban Structure in 2020

4.3.4 Urban Structure in 2035

Future urban structure in 2035 shall mainly depend upon how to foresee continuity of current trend of urban expansion along the roads, the progress of large-scale private urban development projects and the degree of involvement of PPCC administration to control/manage urban development. Based on this consideration, the PPUTMP Project Team delineates three typical future land use prospects as follows:

Alternative 1: Trend-based case (current trend of urban expansion shall be continued)

Alternative 2: Private-oriented case (large-scale private urban development projects proceed and lead to new urbanizing areas)

Alternative 3: Public-private collaboration case (public sector leads urban development with private cooperation)

The PPUTMP Project Team drew up 6 criteria to assess the alternatives, namely: (1) impacts to environment, (2) impacts to traffic and transport, (3) cost, (4) roles of public sector, (5) project risk, and (6) impacts to housing supply for middle and lower income families in suburban areas. As a result, alternative 3 is selected as most preferable future urban structure to be realized.

The following describes the urban structure in 2035.

(1) Urban Area (Approximately 210 Km²)

The public sector shall lead urban development by providing the infrastructure and utilities at northwestern area of PPCC. Major directions of urban expansion from 2020 to 2035 are as follows:

- Large public investment will be made for constructing transport network and utilities at the north-east area to guide private investment of housing and real estate development. This area will form new urbanized areas;
- Urban area in 2020 continues to expand mainly to the west (NR4) direction;
- Urban area in 2020 expands built-up areas to the areas behind from road side; and
- Logistics and industrial complex will be formulated by government initiatives where existing factories and warehouses in downtown area shall be relocated to. The area is around the

intersection of RR-III and railway southern line.

(2) Land Use and Density

Inside of IRR: high and mid-density mixed land use

Outside of IRR: mid-density at private development areas and the area along NR4, the other area, low density

Industrial areas along Veng Sreng Road, NR4 and RR-III

Industrial areas at RR-II/NR1 and at RR-III/NR6

Other mainly outside of RR-III: Green and farm land, water body, vacant land etc.

(3) Urban Centers

Urban Center (Boueng Kok, Monivong, Diamond City)

Nine (9) Sub-centers (Chbar Ampov, Chak Angrae Kraom, Kandal, Stueng Mean Chey, Cheung Aek, Phleung Chheh Roteh, Krang Thnong, Grand Phnom Penh, Camko City)

Production Center (Chaom Chau, RR-III)

Two (2) Production Sub-centers (Preaek Aeng, Bak Kaeng)

(4) Transport Network

Major Transport Nodes : Phnom Penh Port, New Phnom Penh Port, International Airport (Planned New International Airport located at Kampong Chhunang)

- Major Corridors :
- North-South Transport Corridor including 5 sub-corridors supports the urban institutional, business and commercial activities
 - East-West Transport Corridor including 3 sub-corridors supports the urban industrial and commodity activities
 - New Urban Sub-center Transport Corridor (Urban Center - Krang Thnong) supports the urban activities in the new urban sub-center
 - Ring Transport Corridor (Grand Phnom Penh - Stueng Mean Chey) supports the urban connectivity

Regional Corridors : ■ Growth Corridor and Indochina Central Corridor: Sihanoukville - NR4 - PPCC - NR6

■ Indochina Southern Corridor: NR1 - PPCC – NR6

Mode Interchange : Both ends and intersection of major transport corridors

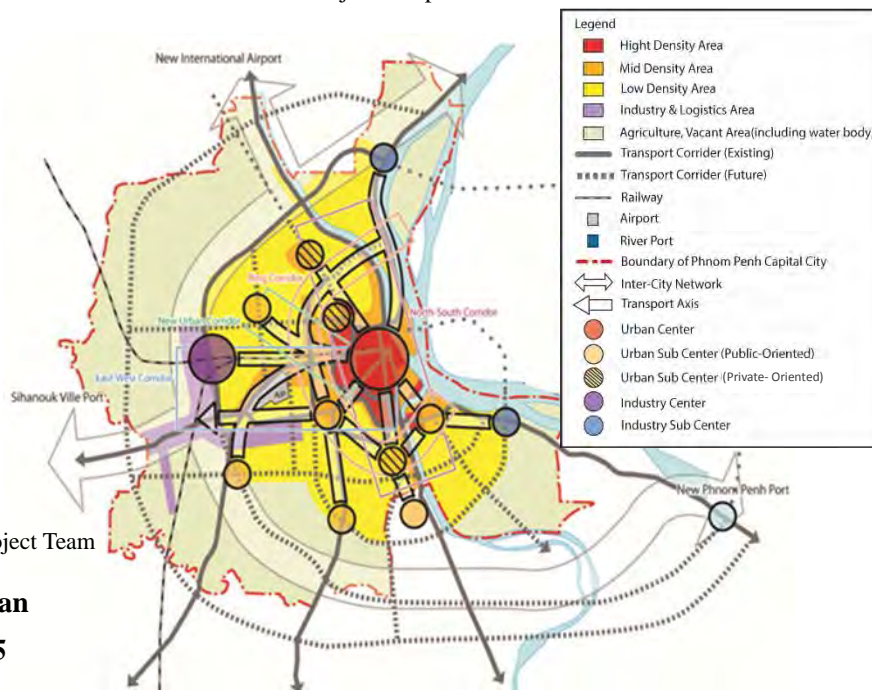

Source: PPUTMP Project Team

Figure 4.3-3 Urban Structure in 2035

5. TRAFFIC DEMAND FORECAST

5.1 Traffic Demand Forecast

5.1.1 Forecasting Approach

For the travel demand forecasting, the traditional four-step methodology consisting of 1) trip production and attraction estimation, 2) trip distribution estimation, 3) modal share estimation, and 4) traffic assignment is basically applied. Furthermore, model development policies are established, considering the following issues found in present situation analysis:

- Transportation characteristics are distinct by individual attribute. Specially, travel mode depends on whether a household owns a passenger-car or not. Therefore, forecasting models should be developed by vehicle ownership level.
- There is no urban public transport system in this city so that modal choice depends not on destination of travel but on vehicle ownership. Therefore, a trip-end model that decides mode choice when leaving home is employed.

First, the future population established by the previous chapter is distributed into four groups of vehicle ownership, namely, no vehicles owned, owning one motorbike, owning two or more motorbikes, and car-owning, with a model forecasting. This will be carried out by inputting household income in the future into models that are developed through analysis of the relationship between vehicle ownership rate and household income. Next, trip productions and attractions will be estimated by traffic analysis zone (TAZ) and the four groups with the distributed population; and then trip distribution will be forecasted to make an origin-destination (OD) table by trip purpose. Finally, the OD table by trip purpose and vehicle ownership group will be distributed into trips by mode: walking, motorbike, passenger car, and para-transit. The OD tables by mode will be distributed on a transport network so that future transport demand on the network can be achieved.

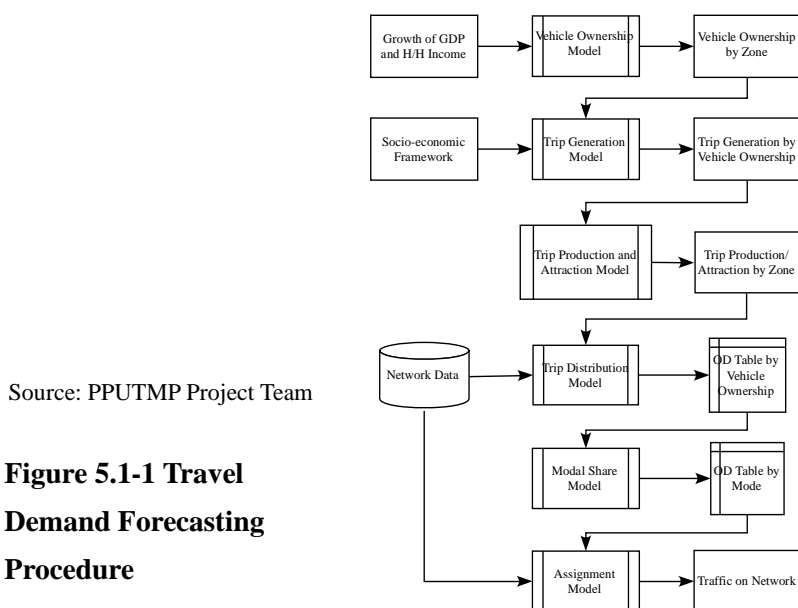
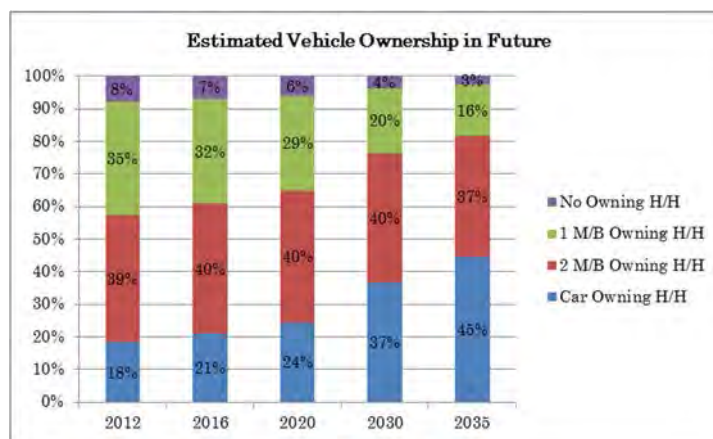

Figure 5.1-1 Travel Demand Forecasting Procedure

5.1.2 Vehicle Ownership

The results of the estimation of vehicle ownership by using the developed models are shown in Figure 5.1-2 and summarized as follows:

The number of car-owning households in 2012 was 69.3 thousand, or a percentage share of 18.4%. In 2035, it is estimated that this number will grow to 259 thousand, or 44.5%, which is an increase of 3.7 times. On the other hand, non-vehicle-owning households will drop to about 2%, which means almost all households will own a motorbike and/or a passenger car in the future.



Note: H/H: Household and M/B Motorbike

Source: PPUTMP Project Team

Figure 5.1-2 Change in Vehicle Ownership in the Future

5.1.3 Future Travel Demand

(1) Number of Trip Generation

The future trip generation, defined as total number of trips produced in the Project area, can be estimated by vehicle ownership and travel purpose by multiplying the population with the trip rate as shown in Table 5.1-1. In total, the number of trips generated is estimated at 6,971.7 thousand trips corresponding to the population of 2,867.6 thousand in 2035. The increase in trips from 2012 to 2035 is about 2,677 thousand, which is 1.6 times that in 2012.

Table 5.1-1 Estimated Number of Trips Generated by Residents in 2035

Vehicle Ownership	Population (1,000)	Number of Trips by Purpose (1,000 trips)					Total
		To Home	To Work	To School	Business	Private	
Non-Owning H/H	75.3	80.4	33.3	20.1	11.8	16.6	162.2
1 M/C Owning H/H	452.1	485.2	183.2	142.8	57.7	116.3	985.2
2 M/C Owning H/H	1,063.2	1,207.8	488.9	356.9	125.2	279.1	2,457.8
Car-Owning H/H	1,277.1	1,649.9	711.3	500.6	132.8	371.9	3,366.5
Total	2,867.6	3,423.3	1,416.6	1,020.4	327.4	783.9	6,971.7

Note: H/H: Household and M/B: Motorbike

Source: PPUTMP Project Team

(2) Trip Production and Attraction

The following figures show the estimated trip productions and attractions by purpose (excluding “to home”), summarized in the 17 integrated zones.

A large number of trip productions can be seen in the following zones in 2035: Doun Penh and Prampir Meakkara (Integrated Zone=1), Chamkar Mon (2), Boeng Tumpun and Chak Angrae (5), Stueng Mean Chey (6), and Posen Chey (15). It is clear by looking at the difference between the present and future that neighboring zones of the central area, such as Boeng Tumpun and Chak Angrae (5), Stueng Mean Chey (6), and Sen Sok (8), have a big increase of trip productions.

On the contrary, the zones attracting a large number of trips in 2035 are concentrated in the central area of four districts, namely, Chamkar Mon, Doun Penh, Prampir Meakkara, and Toul Kouk. These districts’ trip attractions originate from the zones with large productions of the neighboring zones. The increase in trip attractions from 2012 at these four districts can be estimated at more than 600 thousand trips (excluding “to home” trips).

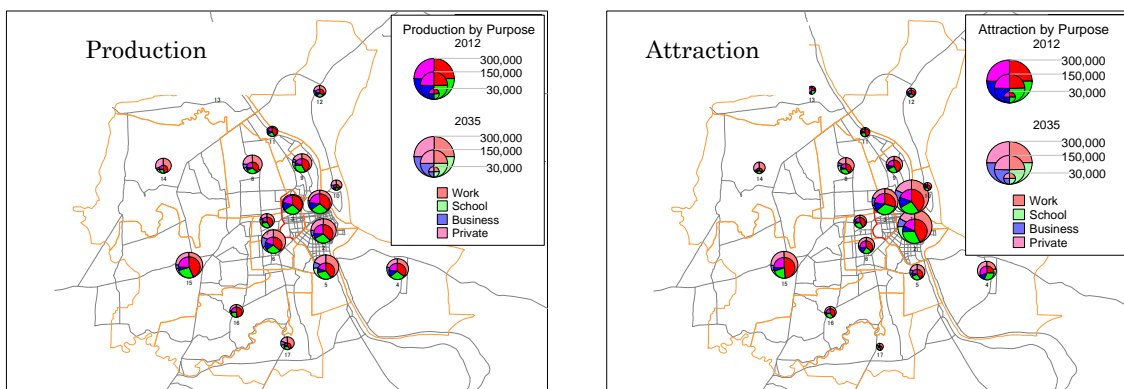

Source: PPUTMP Project Team

Figure 5.1-3 Increase of Trip Production and Attraction

(3) Trip Distribution

Trip distribution increases between all of the zones in the Project area, especially the western zones such as Stueng Mean Chey (Integrated zone=6), Tuek Thla (7), Dang Kao (15), to/from the four districts in the central area; and the southern zones such as Boeng Tumpun (5) to/from the central area are expected to have a high volume of transport demand in 2035, while trip distribution was concentrated only in the central area and its neighboring zones in 2012.

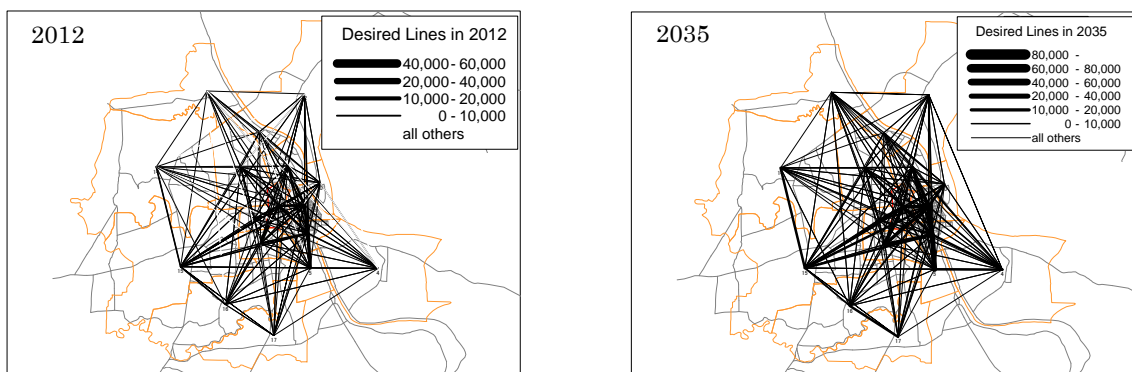

Source: PPUTMP Project Team

Figure 5.1-4 Growth of Trip Distribution

(4) Modal Share

When public transport service is not existing in the city, Mode choice by trip makers any depend upon the vehicle ownership of the household they belong to. Therefore the results of forecasting show a case based on an assumption that no comprehensive public transport is introduced and socio-economic frame is enlarged.

The following table shows a comparison of modal shares of four representative modes between 2012 and 2035. In 2035, the number of trips by passenger car is estimated at 1,198.6 thousand, which is 17.2% of the total trips. The increase of passenger car trips from 2012 exceeds 780 thousand trips. The modal share of motorbikes indicates 55.0% in 2035, while it is 52.4% in 2012. In the case of motorbike trips, the share does not show a large increase but the increase of trips is considerable with 1,610 thousand trips, and this may be a heavy burden to traffic on the road network in the future.

Table 5.1-2 Change of Modal Share

Travel Mode	2012		2035	
	Trips (1,000)	Share (%)	Trips (1,000)	Share (%)
Walk	1,031.2	24.3	1,146.5	16.4
Motorbike	2,223.5	52.4	3,834.0	55.0
Car	421.6	9.9	1,198.6	17.2
Paratransit	570.5	13.4	792.6	11.4
Total	4,246.8	100.0	6,971.7	100.0

Source: PPUTMP Project Team

A large number of trips by passenger car generates from neighboring zones of the central area such as Stueng Mean Chey, whose total trips are very large because of the population and the size of the zones. In the central area, Boeng Keng Kang (TAZ=6), Umnob Tuek (10), and Veal Vong (33) have huge production of trips by passenger car.

The zones along major roads, namely, Tonle Basak (3), Boeng Keng Kang (4, 6), and Boeng Trabaek (13) along Monivong street, Tumnob Tuek (10) along Monireth Boulevard, and Mittakpheap (32) and Tuek L'ak (38) along Russian Blvd. have large concentrations of passenger car trips in the future. And it is obvious that the trips by para-transit concentrate in zones such as Phasar Kandal (19), Ou Ruessei (27), and Phsar Daeum (43) where major markets exist.

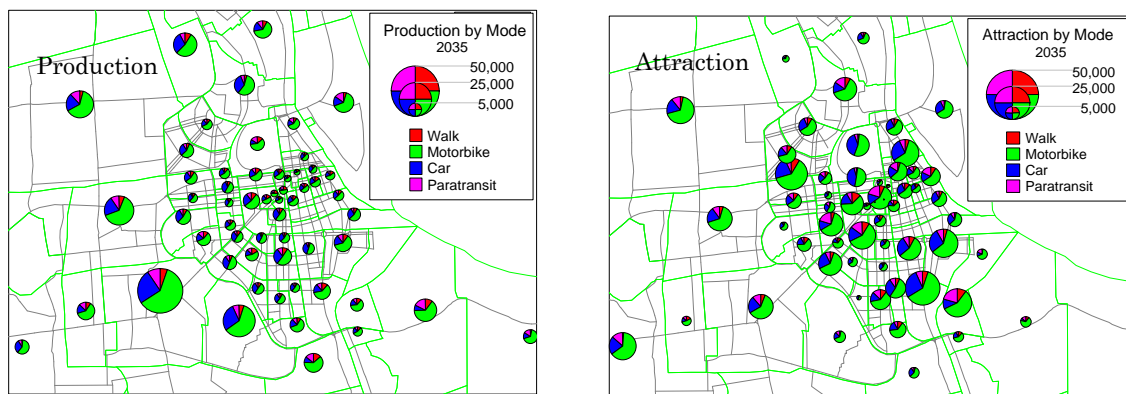

Source: PPUTMP Project Team

Figure 5.1-5 Modal Share by TAZ in the Future

5.1.4 Traffic Estimation on Network

Traffic volume can be estimated by assigning transport demand (OD tables) on a transport network. There are several cases of traffic assignment according to the application of several transport networks. In this section, the following will be analysed :

- Present Case: The present OD table will be distributed on the present network.
- “Do Nothing” Case: The future transport demand will be distributed on the present network.
- Road Improvement Case: The future transport demand will be distributed on a network with some roads in proved.

The volume capacity ratio of the urban area indicates 0.874 in 2012, which means transport demand is reaching capacity, while that of the suburban area is 0.437, which means there is a surplus in capacity. However, the volume capacity ratio in the “Do Nothing” case becomes 1.778 in the urban area and 0.766 in the suburban area. The urban area’s congestion in this case is extremely high and actually unmanageable, and therefore, some improvement is indispensable.

With comparing the V/C values of “Do Nothing” case and road improvement case, there is sufficient improvement in congestion. However, the volume capacity ratio in the urban area still remains over 1.2 and this suggests measures more than road improvement such as an introduction of public transport system are necessary in 2035 even for the road improvement case.

Table 5.1-3 Performance Indicators by Assignment Case

Case	Volume Capacity Ratio			Average Travel Speed		
	Urban	Suburban	Total	Urban	Suburban	Total
Present Case	0.874	0.437	0.515	21.9	37.8	31.0
Do Nothing	1.778	0.766	0.947	13.3	26.3	19.8
Road Improvement	1.251	0.301	0.383	18.3	39.2	29.6

Note: Urban means inside IRR and suburban means outside.

Source: PPUTMP Project Team

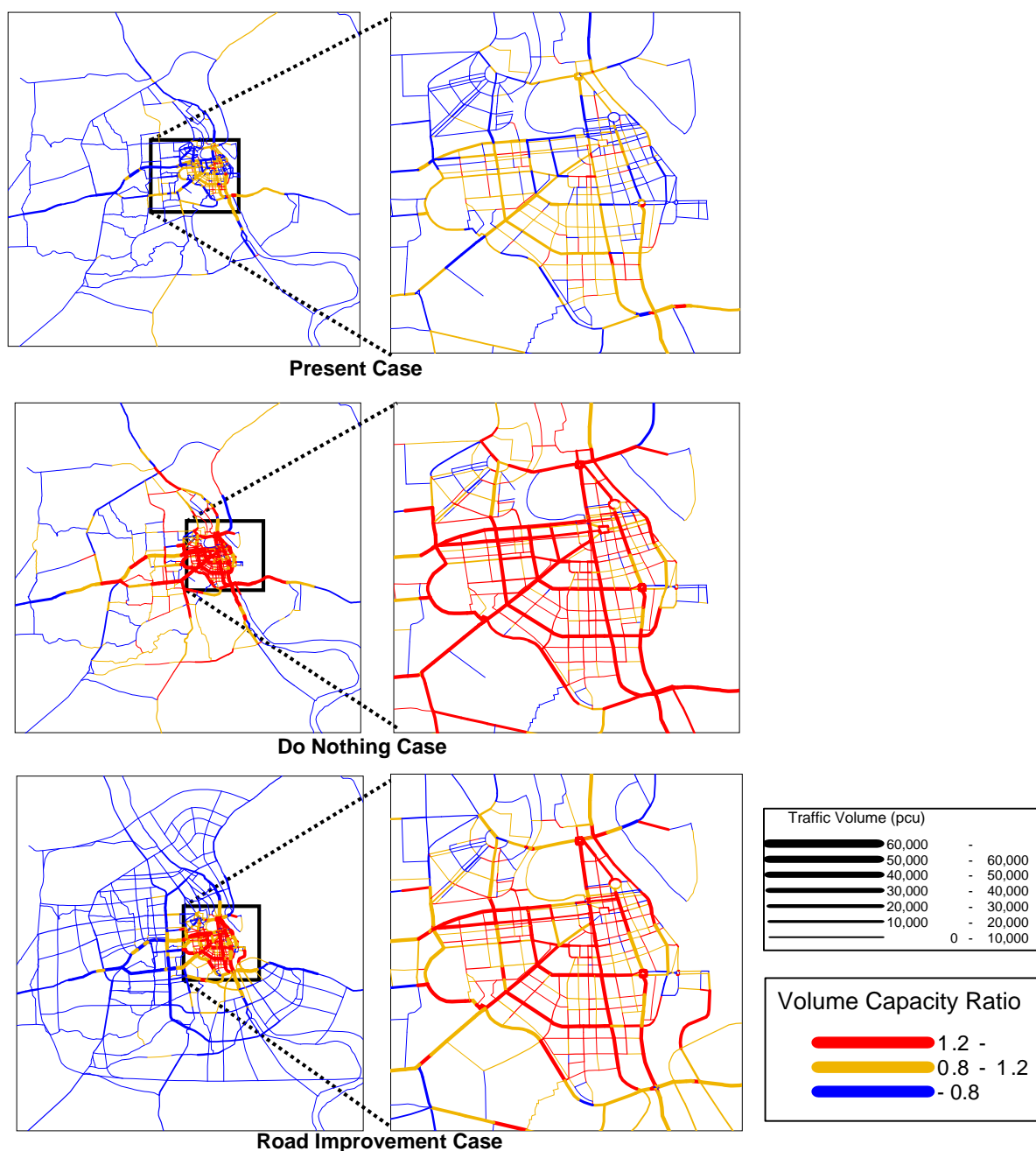

Source: PPUTMP Project Team

Figure 5.1-6 Traffic Assigned on Network

5.2 Freight Traffic Demand Forecast

Future truck traffic volume for cargo transport in the Project area is forecasted by following steps in order to evaluate urban cargo transport and facility policy and plan.

5.2.1 Estimation of Current Truck OD and Demand Forecast Model Building

- Based on the interview survey at cargo facility and with truck drivers, a truck trip generation model, where the explanatory variables include number of secondary workers by traffic analysis zone, is

developed. A truck trip distribution model is also developed to estimate the number of truck trips between origin and destination zones, where the explanatory variables include zonal truck trip generation. Average daily truck operation rate and average daily truck trip rate are also calculated by the result of survey.

- A control total of truck trips relevant to the Project area is estimated by multiplying estimated number of registered trucks with average daily operation rate and trip rate.
- External OD of truck trip including through truck across the Project area is estimated by cordon line survey.
- A control total of internal truck trips within the Project area is the difference between control total relevant to Project area and external OD of truck. Estimated internal truck trip OD matrices are adjusted by control total of internal truck trip within the Project area.
- Current truck OD is estimated by merging external truck OD including through truck trip and internal truck OD within the Project area.
- Estimated current truck OD is assigned on the road network and adjusted by truck volume of screen line survey.

5.2.2 Future Truck OD Forecasting

Future truck OD relevant to the Project area is forecasted by the following steps.

- Growth rate of future cargo flow volume between the Project area and external zone is estimated by forecasted annual growth rate of export and import of Cambodia by type of commodity and partner region in 2035. Future cargo flow between the Project area and external zone is calculated by growth rate and current external OD based on the cordon line survey.
- Considering improvement of railway service in future, such as Northern line and Southern line, future cargo volume transported by railway in 2035 is estimated by expected capacity of cargo railway and type of commodity transferred from truck to railway. External cargo OD transferred from truck to railway is divided into two trips, namely, external cargo OD by railway between origin/destination in external zone and railway station in the Project area, and internal cargo OD by truck between railway station and final destination or origin.
- Future cargo OD at Phnom Penh Port is estimated by growth rate of external zone. With regards to cargo transferred from existing Phnom Penh Port to new port, origin or destination zone is changed from existing Phnom Penh Port to new port in external of the Project area. Future cargo at new port is defined by the capacity of the port which is distributed to the special economic zone (SEZ) in the Project area and to neighbouring areas in proportion to truck generation based on the area of SEZ. Some commodities such as agricultural products from upstream of Mekong River to Phnom Penh Capital City (PPCC) are expected to transfer from truck to river transport; thus, agricultural products from external zone along Mekong River to PPCC are transferred from truck to river port.

Truck OD in 2012 and 2035 is forecasted by three types of truck, namely, Light truck such as pick up and with a capacity less than 2 tons, Medium such as 2-axle trucks with capacity of more than 2 tons and Heavy such as those with more than 3 axles.

6. FORMULATION OF 2035 URBAN TRANSPORT MASTER PLAN

6.1 Goal, Mission and Target of the Master Plan

6.1.1 Goal and Mission

The introduction of public transport in Phnom Penh Capital City (PPCC) which was proposed by the Urban Transport Master Plan in 2001 (JICA 2001MP) has not materialized to date. On the other hand, the city has been developed by supporting a road-oriented transport system.

However, the volume-capacity rate in the City Centre is still more than 1.00 (1.25) by traffic demand assignment on the 2035 road network, as described in Chapter 5, and the new road development in the city centre is very limited, due to land constrain, especially major trunk roads located in the dense city area. It is obvious that serious traffic congestions exist because of the continuous population influx, and the uncontrolled motorcycle and car increases together with limited road space. To solve these serious traffic conditions fundamentally, it is necessary to change the road-oriented urban transport system and make more effective use of the limited urban road space.

On the other hand, the following problems and issues are also pointed out considering the traffic behaviour of Phnom Penh's citizens:

- The choice of modes for Phnom Penh citizens is very limited. Many of them use a motorcycle even for trips of more than 20 km.
- Trip rates between male/female and age group have a big difference. Females and aged people have lower trip rates. This means that many transportation poor have no chance to make trips because there is no available mode of transport that is safe, affordable and comfort.

To cope with these, it is necessary to provide the suitable mode of transport considering the safety, affordability and comfortableness of daily trips.

In terms of future vision and urban structure in Phnom Penh City, following are the key requests in regards to the urban transport:

- To maintain the vitality of Phnom Penh as the Capital City, means that many people coming to the city can expect smooth traffic to provide an efficient road-use mode of transport
- To create a people- and environment-friendly city to create a more comfortable urban space for the people and increase energy efficiency for use of transport mode

Considering the above, the following have been crafted for Phnom Penh's urban transport master plan in 2035:

- The Goal of the Urban Transport Master Plan: Maintain the people- and environment-friendly urban conditions while vitalizing economic activities in Phnom Penh City.
- The Mission of the Urban Transport Master Plan, which is two-fold: 1) to shift from a private-oriented urban transport system to a well-balanced system of public and private transport with a combination of road, public transport and traffic management for improving the mobility of citizens and 2) to guide urban development direction of Phnom Penh City.

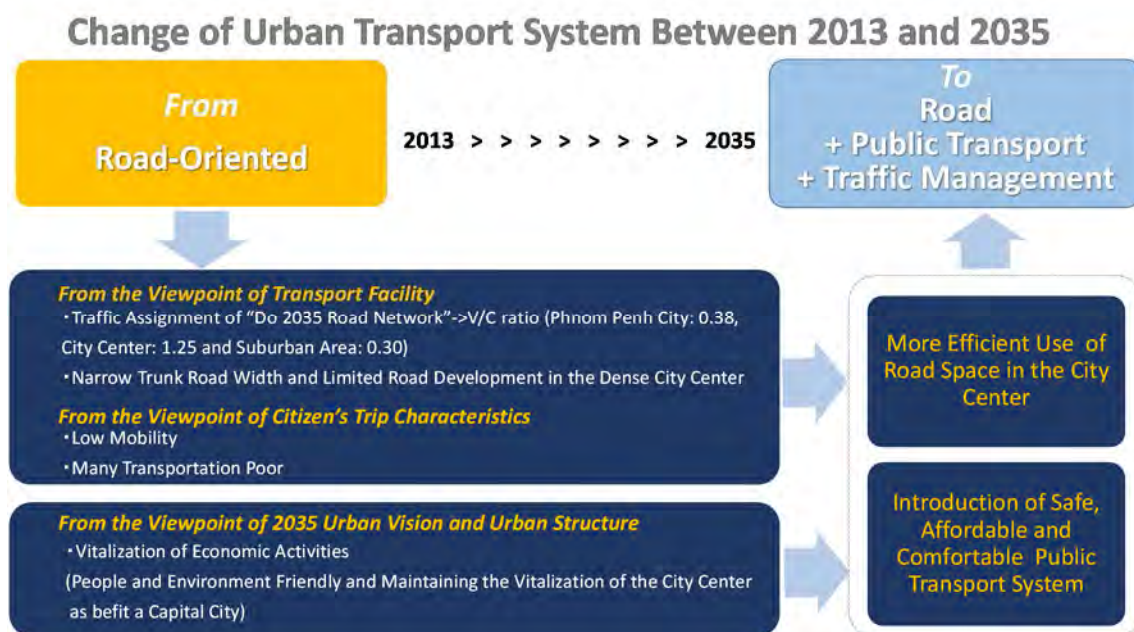

Source: PPUTMP Project Team

Figure 6.1-1 Change of Urban Transport System between 2013 and 2035

6.1.2 Target

The following four target indicators are set for the evaluation of the urban transport master plan. It is necessary to achieve the targets to materialize a people and environmentally friendly capital city. And these indicators are one of the most important evaluation factors to assess the master plan alternatives as described in Section 6.6.

Target indicator 1: To develop the urban transport system with more than 30% of total trip makers using public transport in 2035. Verification of target public transport modal share refers to Appendix 4.

Target indicator 2: To develop the urban transport system with less than 1.0 of volume-to-capacity ratio in the city centre.

Target indicator 3: To maintain the travel speed in the city centre at a level higher than 20 km/hour.

Target indicator 4: The urban transport system with 10% reduction of volume of air pollutants from vehicles in the "Do-Nothing" case will be developed for the materialization of a sustainable environmentally friendly city.

6.2 Development of the Master Plan Strategy

Considering the current urban transport problems/issues, future urban structure and traffic demand forecast, the following five strategies are set for the materialization of the mission of the master plan.

Strategy 1: Formulation of people and environmentally friendly urban transport system with high mobility for the citizens

To achieve this, it is necessary to introduce public transport that is clean, safe, punctual, affordable and operated throughout the day, and performs a seamless transfer between modes.

Strategy 2: Formulation of physical framework of the city and creation of smooth connection between major cities in the Mekong Sub-region

The development of road system is 1) to formulate the urban framework, 2) to provide the road network with an appropriate distance to the spread of the urbanized area, 3) to develop smooth flow in the Mekong Sub-region and 4) to preserve the urban environment through the formulation of physical framework.

Strategy 3: Maximum use of existing transport spaces including underground and elevated spaces in the city centre

To achieve this, the release of sidewalk to pedestrians, the effective use of local roads for people walking, parking and vehicular traffic, the reuse of railway for urban transport and the effective use of water transport (ferry) are to be considered. It is necessary to consider the use of new urban spaces such as underground and elevated space.

Strategy 4: Efficient traffic flow for commodity

The development of commodity flow planning is to support not only the urban vitality but also a comfortable and safe urban life.

Strategy 5: Environmental/social considerations and establishing appropriate transport-related organizations for implementation of the master plan

The key of sustainability of the Master Plan is the comprehensive environmental considerations. The keys of materialization and sustainability of the Master Plan are the establishment of an appropriate urban transport-related organization, considering financial mechanism including private participation and the participation of many stakeholders.

6.3 Master Plan Formulation

Based on above sections 6.1 (Goal, Mission and Targets) and 6.2 (Strategy), the urban transport master plan is formulated step by step as shown below.

- a) Planning concept (relationship between urban transport system and urban structure): Section 6.4;
- b) Contents of the urban transport system (master plan's main components): Section 6.5;
- c) Proposed urban transport system alternatives: Section 6.6;
- d) Evaluation of alternatives: Section 6.7;
- e) Recommended conceptual picture of the master plan: Section 6.8;
- f) Master plan components by sector: Section 6.9; and
- g) Roadmap to the master plan materialization: Section 6.10.

6.4 Planning Concept

6.4.1 Relationship between Urban Transport System and Urban Structure

The urban transport system, which contains the main components of the master plan, plays an important role as basic framework to support the future urban structure. This concept of physical structure, shown in Figure 6.4-1, mainly consists of 4 levels; namely, urban structure level plus 3 main components of the Master Plan (road network level, public transport level and traffic management which is supporting measures to maximize the road and public transport are difficult to present as an overall physical plan).

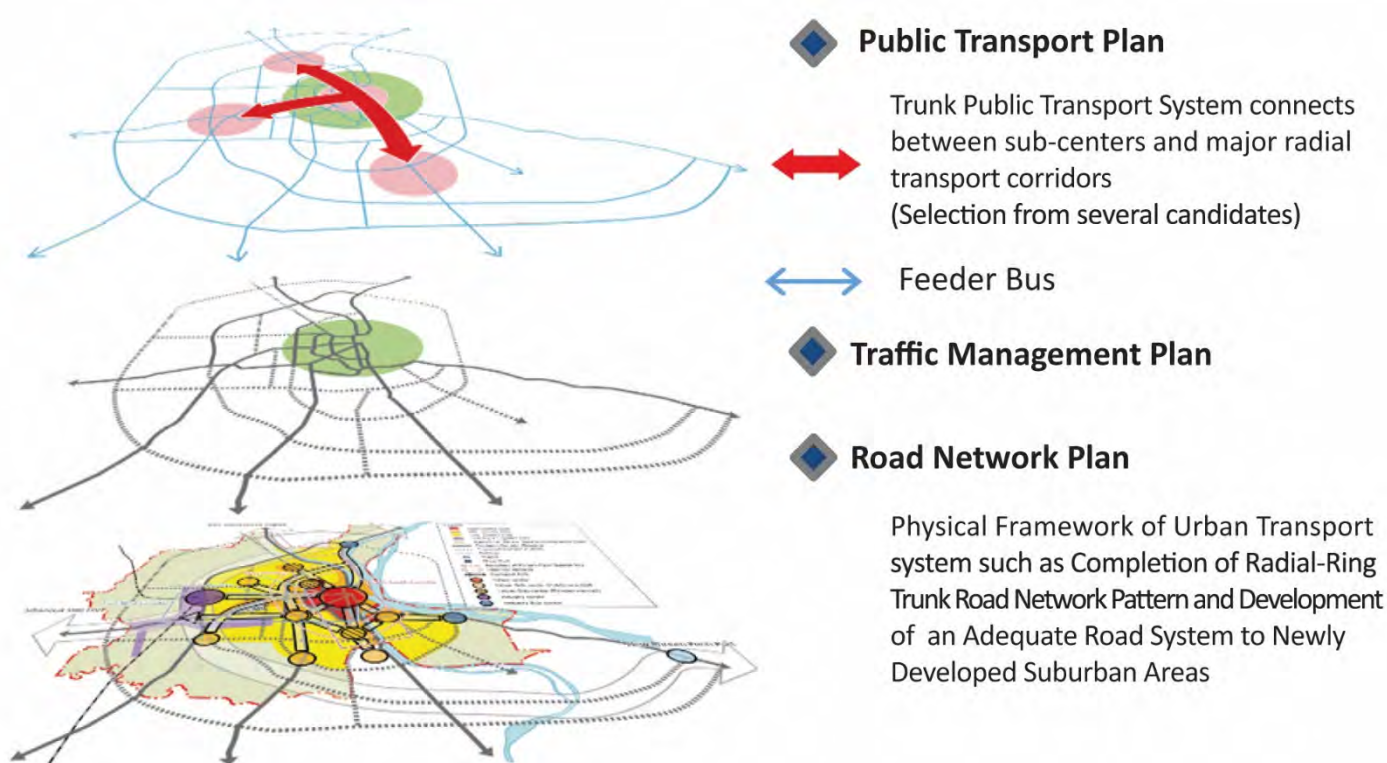

Source: PPUTMP Project Team

Figure 6.4-1 How to Support the 2035 Urban Structure

6.5 Contents of the Urban Transport System

6.5.1 Road

The future road system in PPCC, which is the basic framework of the master plan, forms the city's backbone and provides support for the smooth person trips and commodity flow in the Mekong Sub-region.

Outline of the 2035 road network and its road development plan are illustrated in Figure 6.5-1.

Radial and Ring Trunk Road Network System

(6 Radial and 4 Ring Trunk Roads)

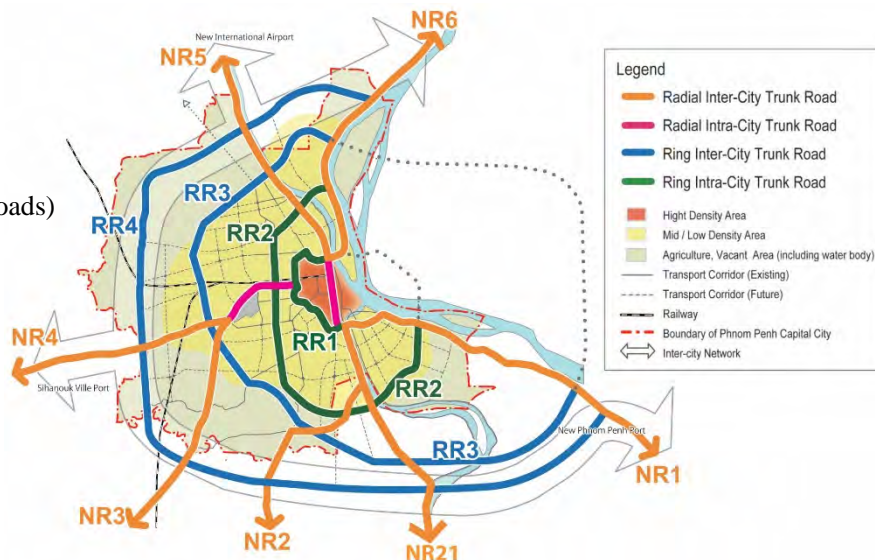

Road Development Plan

(Strengthen east-west (northern and southern east-west trunk roads) and north-south (Hanoi and Hun Sen Blvd.) corridors)

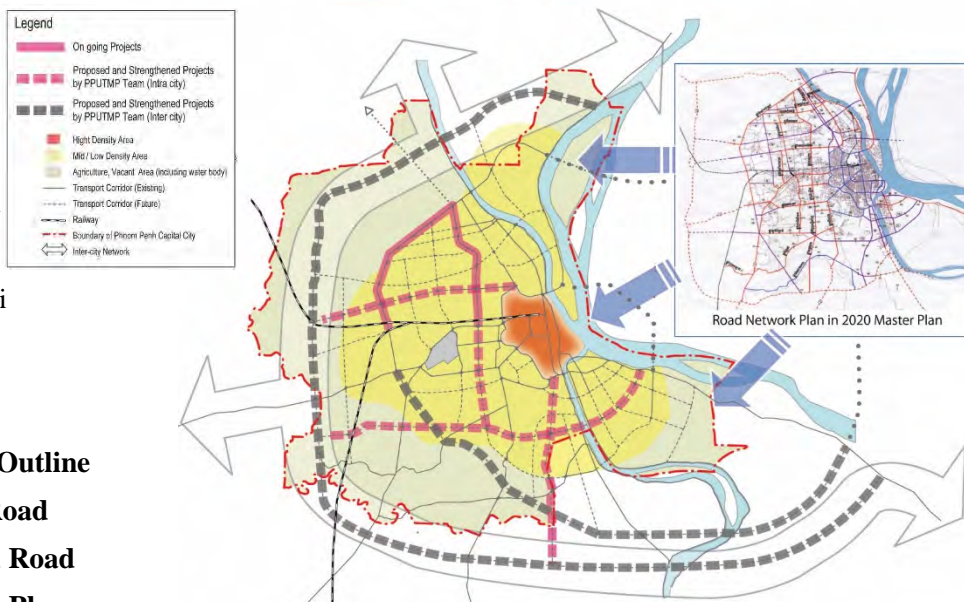

Figure 6.5-1 Outline of the 2035 Road Network and Road Development Plan

Source: PPUTMP Project Team

6.5.2 Public Transport

(1) Why the Need for Public Transport?

Study and analysis performed by the Project pointed out the following facts that clearly show the need for public transport in PPCC:

- Limited road space in the city center and slow road development speed in the suburban area
It is impossible to cope with the increased traffic by focusing solely on the road system especially in the dense city centre where there is no room to develop new roads.
Without public transport in PPCC, it would be impossible to cope with the increase in traffic.
- Low mobility and many transportation poor
The mobility of many citizens is low because their trip mode choice is limited to private mode such as cars and motorcycles.

c) Inefficient use of para-transit modes

Needless to say, there is a limited public transport available in PPCC with only the 3-route bus system and the widely popular para-transit modes such as Motodop, Motorumok Modern (tuk-tuk). The latter, however, can be efficiently used in the role of feeder for the trunk public transport system.

d) Lagging behind in public transport system to be a major Asian city contender

A comparison was made of six cities (Phnom Penh, Hanoi, Kuala Lumpur, Lyon, Hiroshima and Curitiba) with almost the same area and population size as PPCC. All sample cities, except for PPCC (because it is just starting the 3-route bus operation), have a public transport system. In fact, many of them have several alternative systems. It can be said that a public transport system especially the well-networked bus system is the minimum requirement for dense city centres.

(2) Where to Plan the Public Transport?

Based on the corridor analysis graphical presentation of the trunk public transport corridors and their respective characteristics is made as shown in Figure 6.5-2.

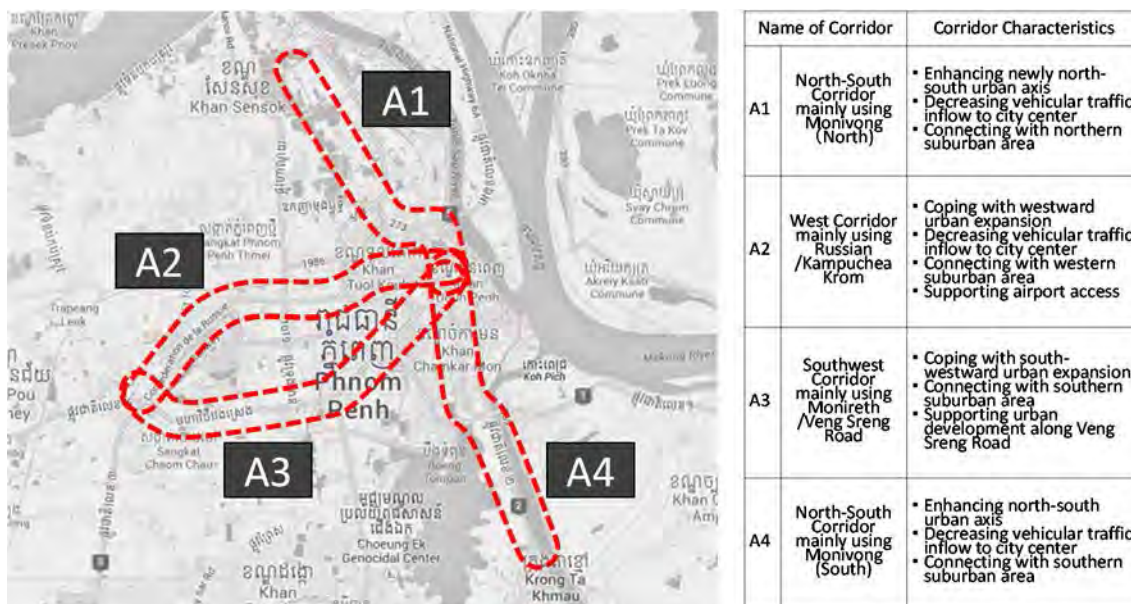

Source: PPUTMP Project Team

Figure 6.5-2 Selected Public Transport Corridors

(3) What Kind of Public Transport System Should be Introduced?

Based on the previous several proposals and such conditions as future vehicular traffic demand and low skyline of the city centre, public transport candidates are proposed, and these are shown in table 6.5-1.

Table 6.5-1 What Kind of Public Transport System should be Introduced?

Type of Public Transport	Right of Way	Remarks
Public Transport (PT) Candidate 1: Bus-Oriented	Surface streets with mixed traffic	Proposed by JICA 2001 MP
PT Candidate 2: BRT or Tram	Longitudinally separated but with at-grade crossing	Proposed by French SYSTRA Team
PT Candidate 3: Elevated Rail Transit	Fully controlled right of way without at-grade crossing	Proposed by METI Project Team in 2009
PT Candidate 4: Partially Underground Elevated Rail Transit		Proposed by PPUTMP project Team

Note: 'Right of Way' is modified from Vukan R. Vuchic's 'Urban Transit: Operations, Planning and Economics'.

'METI' is the Ministry of Economy, Trade and Industry in Japan.

Source: PPUTMP Project Team

6.5.3 Traffic Management Measures

It is necessary to develop traffic management measures that will enable the road and public transport to work effectively. Especially, it is important to develop mode interchange areas as convenient transfer points with such facilities as bus stops and rail stations, providing connection between modes, and a well-designed pedestrian environment. Various traffic management measures to the road and public transport system are as follows:

- a) Various measures for increasing the attractiveness and comfort of the public transport system
- b) Various traffic management measures such as intersection improvement, traffic signal upgrading and introduction of one-way system
- c) Parking policies and measures such as increasing parking fee and effectively use for parking space on local roads
- d) Pedestrian environment development
- e) Introduction of traffic demand management including mobility management which is a concept to promote sustainable transport and manage the demand for car use by changing travelers' attitudes and behavior.

Traffic demand management (TDM) is one of the many traffic countermeasures used to influence and change the travel needs of people with the eventual aims of reducing traffic congestions, improving traffic safety, saving fuel consumption and hence, reducing vehicle exhaust gases.

Basically, it is an approach that attempts to control the supply side of the transportation economics. This is done by controlling the supply of road and parking spaces in restraining use of the less efficient private transport modes, while promoting more efficient modes like mass railway transit system in meeting the increases in travel demand. In this manner, it tries to strike a balance between the demand and supply within the environmental limitations such as urban land and financial constraints (see Figure 6.5-3).

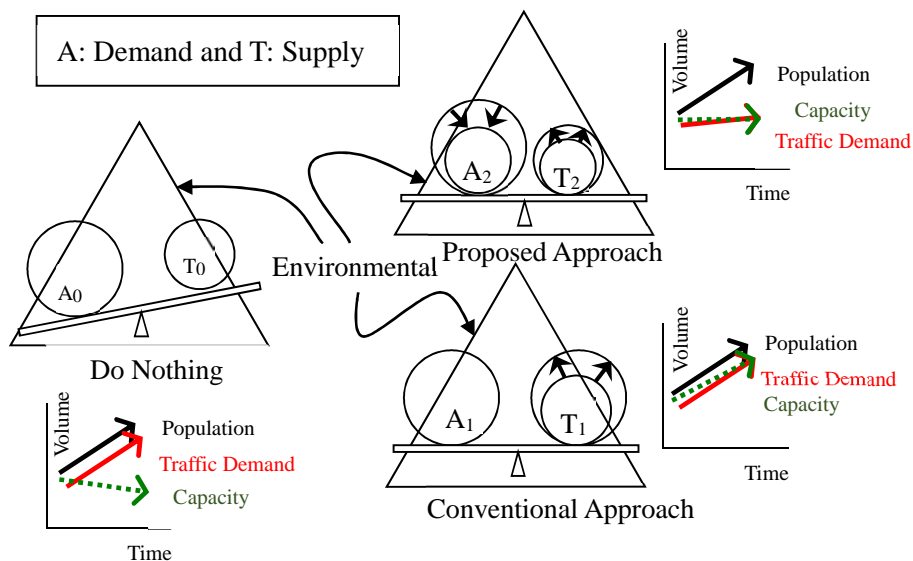

Source: PPUTMP Project Team

Figure 6.5-3 Concept of TDM

6.6 Urban Transport System Alternative

It is difficult to maintain appropriate urban transport conditions with only road development. What is needed is the combination of road, public transport and traffic management as an urban transport system to achieve the mission of this master plan.

Therefore, the following five alternatives are presented based on the study of the components of the urban transport system described in Section 6.5:

- Alternative 1: Bus-oriented + Road Network Improvement + Traffic Management Measures
- Alternative 2: Tram or BRT (Road-based segregated system) + Road Network Improvement + Traffic Management Measures
- Alternative 3: Combination of Tram/BRT and Elevated Transit + Road Network Improvement + Traffic Management Measures
- Alternative 4: Elevated Rail Transit (LRT or Monorail) + Road Network Improvement + Traffic Management Measures
- Alternative 5: Partially Underground Elevated Rail Transit (LRT) + Road Network Improvement + Traffic Management Measures

ALTERNATIVE		ALTERNATIVE 1	ALTERNATIVE 2	ALTERNATIVE 3	ALTERNATIVE 4	ALTERNATIVE 5
COMPONENTS	ROAD	2035 Road Network (6 Radial and Ring Roads System)				
	TRUNK PUBLIC TRANSPORT+BUS	Bus Oriented	Tram	BRT or Tram Elevated Transit	Elevated Transit	Partially Underground Elevated Transit
	TRAFFIC MANAGEMENT	100 Traffic Signal Improvement + One-Way System + Parking Measures + Sidewalk Improvement				
PLAN	<ul style="list-style-type: none"> — : At-grade — : Elevated ... : Underground 					
IMAGE OF PUBLIC TRANSPORT SYSTEM						

Source: PPUTMP Project Team

Figure 6.6-1 Outline of Proposed Urban Transport System Alternatives





6.7 Evaluation of Alternatives

6.7.1 Evaluation of Alternatives by Four Aspects

The criteria adopted for evaluating the urban transport system alternatives are categorized into four aspects; namely, urban transport, urban planning, environment and economy.

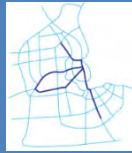
Table 6.7-1 below shows a summary of the evaluation.

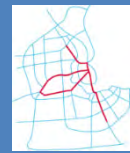
Table 6.7-1 Summary of Evaluation

Alternative		Alternative 1	Alternative 2	Alternative 3	Alternative 4	Alternative 5
						
Evaluation Factor		Bus-Oriented + 2035 Road Network + Supporting Measures	BRT or Tram + 2035 Road Network + Supporting Measures	BRT or Tram + Elevated Transit + 2035 Road Network + Supporting Measures	Elevated Transit + 2035 Road Network + Supporting Measures	Partially Underground Elevated Transit + 2035 Road Network + Supporting Measures
Urban Transport Aspects	Traffic Congestion Rate and Travel Speed in the city centre /Decrease of Vehicle-km and Vehicle-hour			✓	✓	✓
	Degree of Mobility		✓	✓	✓	✓
	Consideration for Transportation Poor		✓			
			↓	↓	↓	↓
Urban Planning Aspects	Harmony with Urban Scenery		✓	✓		✓
	Contribution to the Urban Vitality/ Impact to the Tourism		✓	✓	✓	✓
			↓	↓		↓
Environmental Aspects	Decrease of Air Pollutants and GHG Emission					✓
	Decrease of Traffic Accidents					✓
	Social Environmental Consideration			✓		✓
Economic Aspects	Investment Cost/ Cost-Benefit Ratio			✓		
				↓		↓
Evaluation				✓		✓

Source: PPUTMP Project Team

6.7.2 Overall Evaluation

Based on the evaluation of the 4 aspects, the 2 highest scoring alternatives are examined for the overall evaluation.

Table 6.7-2 Overall Evaluation

	Tram + Elevated Rail Transit	Partially Underground Elevated Rail Transit
Urban Transport Aspects	High mobility and easy to adopt the staging	Lowest negative impact in terms of urban transport performance such as volume-capacity ratio and vehicle-km
Urban Planning Aspects	Match to the Urban Scenery and has great impact to the tourism	Less impact as the urban vitality tool
	Trigger of urban vitality with the development of human and environmentally friendly transit mall along Monivong. <u>(Pedestrian + Tram + Bus)</u>	Trigger of urban vitality with the development of human and environmentally friendly Monivong. <u>(Pedestrian + Bus)</u>
Urban Environmental Aspects	Relatively environmentally friendly urban transport system	Most environmentally friendly urban transport system among 5 Alternatives
Economic Aspects	Reasonable investment cost and adequate cost-benefit ratio	High investment cost and low but feasible cost-benefit ratio
Other Aspects	Public transport becomes symbol of PPCC	Possible to share with private car traffic
	Necessary to share public transport oriented consciousness in the early stage	Possible to share public transport oriented consciousness step by step
Conclusion	Project Team proposes the Alternative 5 (Partially Underground Elevated Rail Transit + Road Network + Traffic Management Measures)	
	Reasons: Environmentally friendly system, has great potential of triggering the City's vitality and making Phnom Penh more appealing as an environmentally friendly compact city to the world. And, it is possible to share public transport oriented consciousness step by step.	

Source: PPUTMP Project Team

6.8 Proposed Concept of the 2035 Urban Transport Master Plan

It is necessary “to shift from a private-oriented urban transport system to a well-balanced system of public and private transport with a combination of road, public transport and traffic management”, which is part of mission of the master plan, for sustaining the urban vitality and minimizing the urban transport demand of the estimated 3million people in PPCC in 2035.

In order to realize this mission, there should be balanced planning of the components of the master plan, between infrastructure development and transport demand management, considering the urban

environment. This master plan should well-consider the above planning concept and the urban transport system (main three components) of the master plan, is briefly explained below and illustrated in Figure 6.8-1.

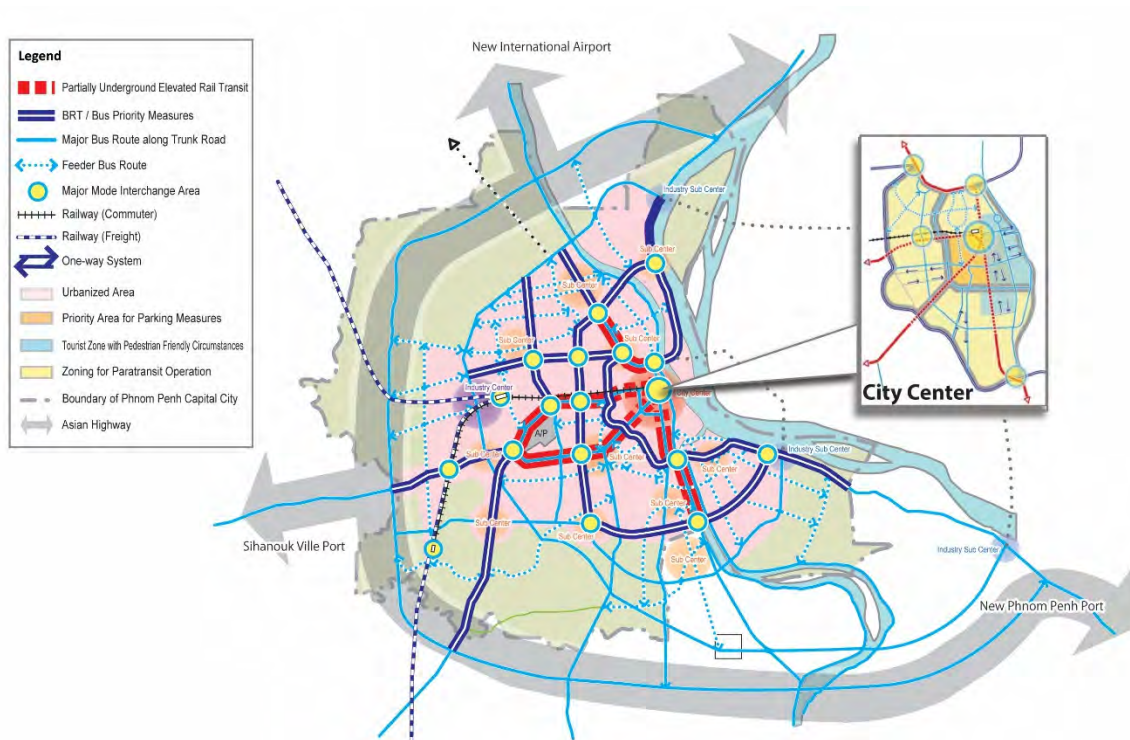

Source: PPUTMP Project Team

Figure 6.8-1 Conceptual Picture of the Proposed 2035 Urban Transport Master Plan

6.9 Master Plan Components by Sector

The ultimate goal of this master plan is “to sustain Phnom Penh’s vitality and have a well-maintained urban transport environment using the limited transport facilities effectively”. Therefore, the planning policy of the sector plan is to prioritize infrastructure development (hardware: increase in transport capacity) within the capability of the city’s urban environment and financial state and with the well-balanced use of traffic demand management (software: decrease in traffic demand).

An outline of the sector plan is shown in Table 6.9-1.

Table 6.9-1 Master Plan Components by Sector

Goal and Target	Strategy	Sector/Component	
<p>GOAL and MISSION -To Achieve the Goal (2035 Urban Vision and Urban Structure), the Mission of the Urban Transport Master Plan is Improving the Mobility and Emerging the Urban Development Potential in Phnom Penh City-</p> <p>Target 1: Share of Public Transport in 2035 is more than 30%.</p> <p>Target 2: Volume-capacity Ratio in the city center is less than 1.0.</p> <p>Target 3: Travel speed in the city center at a level higher than the 20km/hour.</p> <p>Target 4: Decrease of Greenhouse Gas Emission of 10% compared with Do-Nothing Case.</p>	<p>Strategy 1: Formulation of urban transport system with high mobility and serves the needs of the transportation poor</p>	Public Transport System	Introduction of trunk public transportation system with related countermeasures such as mode interchange area development
			Countermeasures for para-transit
			Effective use of existing public transport such as railway and water transport
	<p>Strategy 2: Formulation of physical framework of urban transport system and creation of smooth connection between major cities in the Mekong Sub-region</p>	Road System	Effective use of road space in the city center such as flyover constructions
			Completion of radial-ring pattern trunk road network
			Construction of new roads in the newly developed suburban area
	<p>Strategy 3: Maximum use of existing transport spaces including underground and elevated spaces in the city center</p>	Traffic Management	Introduction of traffic management scheme for effective use of road space in the city center such as one-way system
			Parking measures
			Development of comfortable pedestrian environment
			Driver's education and traffic enforcement
			Traffic Demand Management (TDM) including mobility management
	<p>Strategy 4: Efficient traffic flow for commodity</p>	Commodity Flow	Allocation of commodity flow facilities
			Formulation of commodity flow network
	Roadside loading/unloading of commodities in collaboration with traffic management		
<p>Strategy 5: Environmental/social considerations and establishing appropriate urban transport-related organizations are the fundamental concept of the master plan</p>	Environmental and Social Considerations and others	Prevention of deterioration in air quality/noise and mitigation of CO2 emissions Improvement of urban parks/greenery and keeping diversity of the ecosystem in the suburban area	
		The keys of materialization and sustainability of the Master Plan are the establishment of an appropriate urban transport-related organization, considering financial mechanism including private participation and the participation of many stakeholders.	

Source: PPUTMP Project Team

6.10 Roadmap

The roadmap in this project shows the process of how to materialize the 2035 master plan considering the coordination between master plan sectors. Actually, the Project has three terms, namely, short-term (year 2016), medium-term (year 2020) and long-term (year 2035).

The short-term and long-term actions are clear, i.e., the short-term activities are the immediate actions to cope with the current problems/issues using and low cost countermeasures such as traffic management measures, while the long-term activities are definitely for the materialization of the goal of the master plan.

Therefore, the importance of the roadmap in this project is to clearly define the medium-term actions in relation to the short-term and long-term actions to materialize the goal of the master plan without any discrepancy.

Main points of the medium-term roadmap are as follows;

- (1) In terms of public transport, how to ensure the transition from bus to rail transit as seamless as possible.
- (2) How to complete the radial-ring road network pattern before the medium-term (year 2020).
- (3) How to effectively implement the traffic management measures to cope with the urgent urban transport problems/issues.
- (4) How to adopt the urban transport-related organizations in line with the development of the trunk public transport system.

Based on the above discussion, the master plan roadmap is illustrated in Figure 6.10-1.

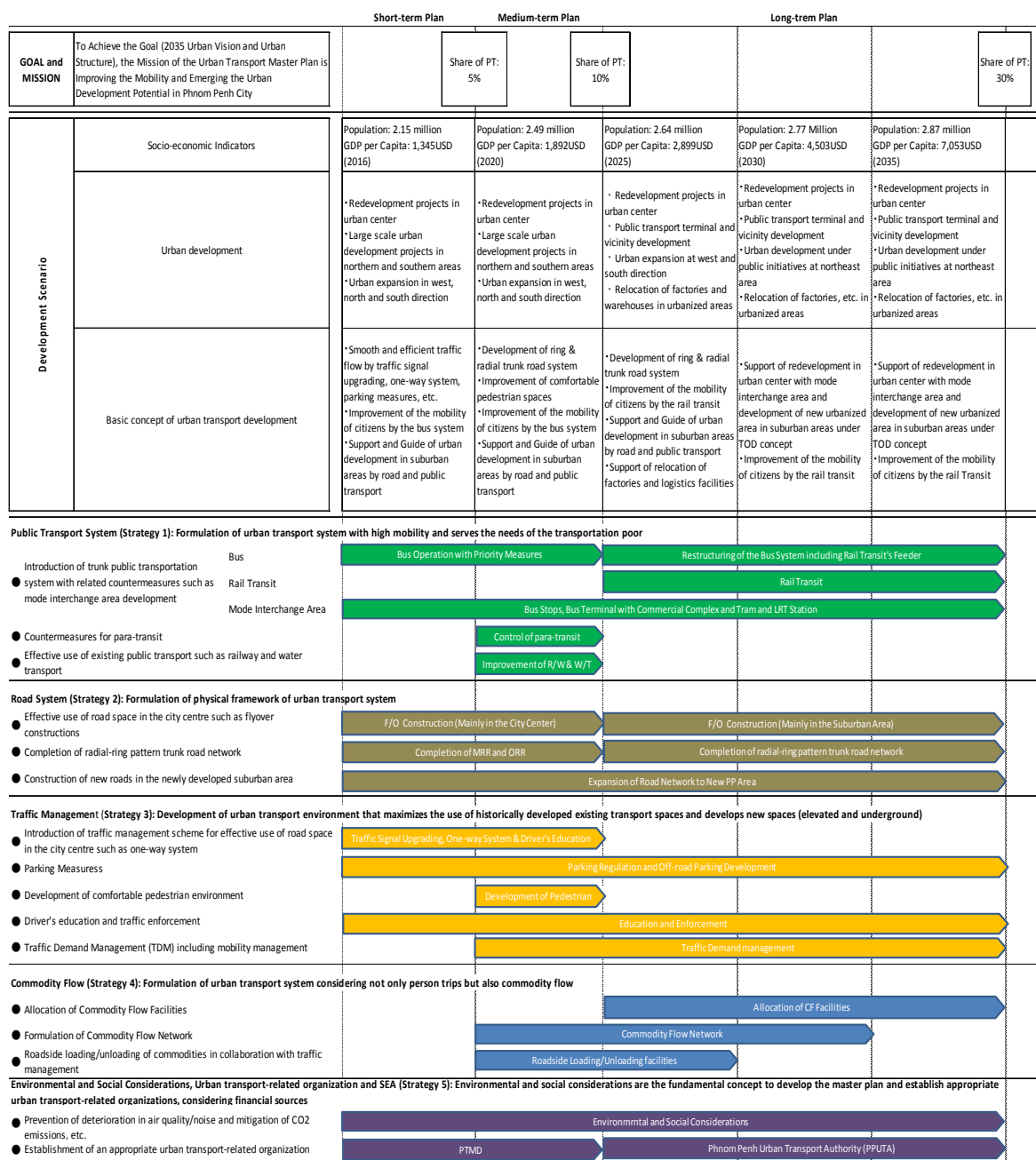

Note: R/T= Rail Transit, R/W= Railway, W/T= Water Transport, CBD= Central Business District, F/O= Flyover
MRR= Middle Ring Road, ORR= Outer Ring Road, PTMD= Public Transport Management Division

PPUTA= Phnom Penh Urban Transport Authority

Source: PPUTMP Project Team

Figure 6.10-1 Roadmap for Urban Transport Master Plan in PPCC

7. SECTOR PLAN

7.1 Public Transport System

7.1.1 Planning Approach

The mission of the Urban Transport Master Plan is 1) to shift from a private-oriented urban transport system to a well-balanced system of public and private transport and a combination of road, public transport and traffic management for improving the mobility of citizens and 2) to materialize the urban potential of Phnom Penh City. In general, the urban transport policy aims at securing people's mobility and rationalizing urban transport systems. Securing people's mobility is to be done by providing both accessibility and mobility to urban facilities necessary for daily life. This mobility should be guaranteed as much as possible for all people. The trip area of people becomes much wider than before, when transport means was limited only to walking, through the emergence of motor vehicles such as motorcycles and cars. However, cars might not be available for all the people, and occasionally, even car drivers are unable to use their own cars due to specific reasons. This is the first reason why public transport is needed.

From the viewpoint of rationalization of urban transport systems, cars are a system which broadly occupies urban roads that are most precious urban space, emits exhaust gas and noise to surrounding area and mostly is not energy-efficient.

Above all, cars might be an important transport means in the urban area, but its performance is very limited under a highly dense urban environment. For Phnom Penh Capital City (PPCC), which is a medium-sized city with its historically developed structure, it is necessary to decrease car trip demand coming into its center due to the low road capacity and difficulty to eliminate spatial constraint in center district. Having to coping with modal shift and encourage mode change from car trips, it then becomes necessary for Phnom Penh to introduce public transport system as a collective transport means.

Focal Points of Public Transport Plan are as follows:

- 1) Focus on Multi-modal Transport Aspect in Urban Mobility
- 2) Introduction of Trunk Public Transportation System
- 3) Broad Integration of Public Transport Means and Related Countermeasures
- 4) Integration with Land-use Plan
- 5) Close Linkage with Tourism Development

7.1.2 Basic Policy of Public Transport System Development

Based on the following public transport development concept, short to medium-term plans for bus network development plan are discussed; then mass transit transport plan is discussed as a long-term plan.

Figure 7.1-1 Concept of Public Transport Development with Change of Trip Modal Share

Source: PPUTMP Project Team

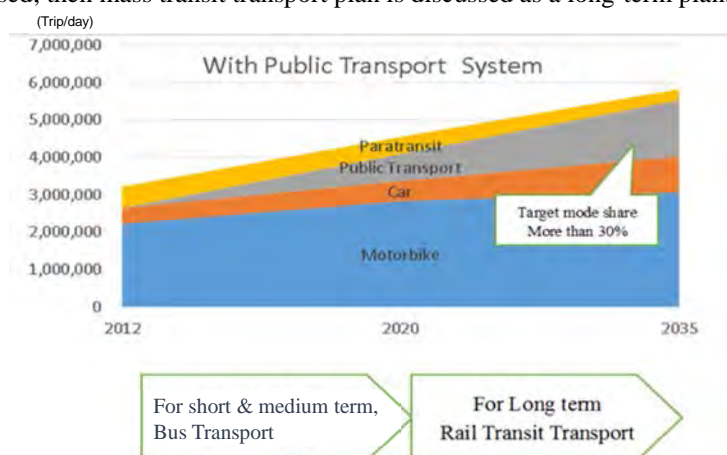

7.1.3 Bus Transport Plan

(1) Basic Considerations

Bus system is the trunk public transport system for the short- to medium-term planning period in Phnom Penh City. Basic considerations of the bus transport plan in short- to medium-term are as follows:

- 1) Starting point of the bus transport plan is the 2nd public experiment (city bus operation) which is one route along Monivong Blvd. with 7.2 km and number of daily passengers is about 1,550;
- 2) Based on the planning and facility criteria such as population/location of facilities and minimum road width of bus route (8 m)/interval of bus stops;
- 3) Major transport corridors, future population and urban structure in 2020; and
- 4) Staging, basically, for short-term, covering the north-south and east-west transport corridors and medium-term, covering the urbanized area in 2020

(2) Medium-term Bus Network Proposal

The proposed medium-term bus network is composed of 3 types of bus route groups, namely, 1) routes covering the north-south corridor, 2) routes covering the east-west corridor, and ring routes covering city center and its peripheral area in 2020. Total number of routes is 10 and population along the bus routes (300 m from the bus route) is 770 thousand (42% of total population in 2012).

Table 7.1-1 Population Covered by Bus Services

Khan	Total Population (2012)	Population by bus services	Average bus service coverage
Chamkar Mon	184,200	151,572	0.82
Doun Penh	212,800	188,280	0.88
Toul Kouk	186,100	122,210	0.66
Dangkao	96,100	4,137	0.04
Por Senchey	269,200	37,214	0.14
Meanchey	443,200	133,673	0.30
Russey Keo	250,500	77,488	0.31
Saensokh	210,100	54,997	0.26
TOTAL	1,852,200	769,571	0.42

Source: PPUTMP Project Team

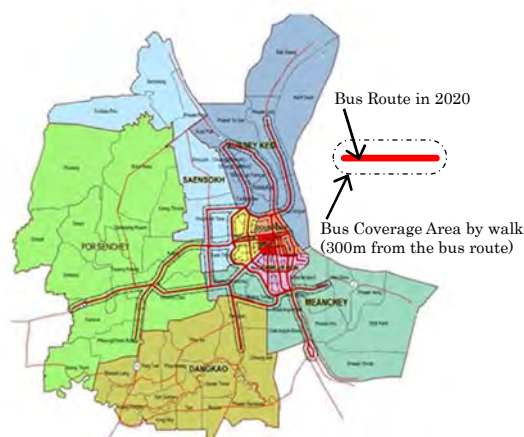

(3) Bus Network Development Staging

Bus network development staging from 2014 to 2020 is performed according to the steps shown below.

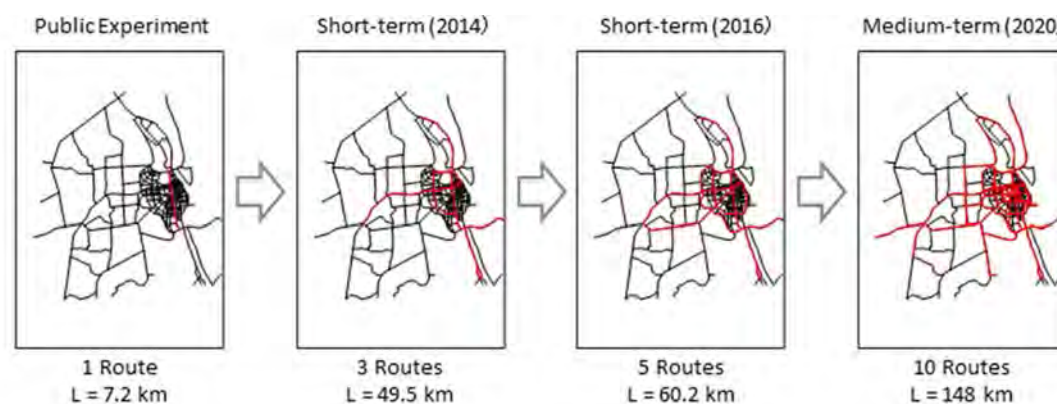

Source: PPUTMP Project Team

Figure 7.1-2 Staging of Bus Route Network for Short to Medium Term

(4) Medium- to long-term bus network after introduction of rail transit system

[Before introduction of rail transit system]

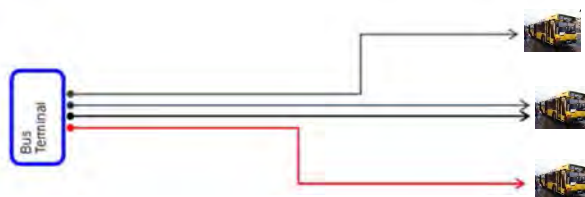

[After introduction of rail transit system]

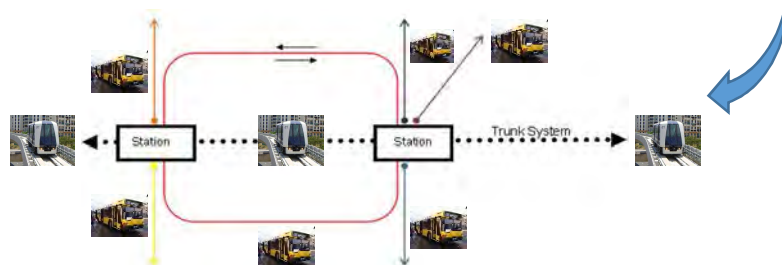

Source: PPUTMP Project Team

Figure 7.1-3 Concept of Bus Route Reorganization in Medium- and Long-Term

7.1.4 Introduction of Trunk Public Transportation System

(1) Candidate of Trunk Public Transportation System

Classification of Mass Transit System

Regarding land transport systems available for urban transport, Table 7.1-2 below provides a practical classification, focusing on the physical/technical aspects.

Table 7.1-2 Classification of Urban Public Transport System

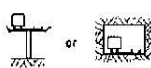
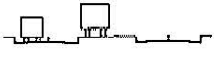
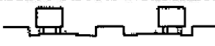
Support mechanism + Guiding type		Steered by driver on the road	Supported by rubber wheel + Guided by guide track	Supported by Steel wheel on the steel rail track
Propulsion		Internal-combustion engine	Electric motor	Electric motor
Right-of-Way	A: Fully controller R/W without grade crossing 	BRT (bus way)	Metro(by rubber wheel), Monorail, AGT	LRT Metro
	B: Longitudinally separated but with grade crossing 	BRT	Guide Bus* *including case of ICE	LRT
	C: Surface streets with mixed traffic 	Bus (on St.)		Tram

Source : modified from Vukan R. Vuchic's Urban Transit: Operations, Planning and Economics

Note: BRT= Bus Rapid Transit, LRT= Elevated Rail Transit

Among the trunk public transport systems, actual transport situation in Japan is selected and summarized in Table 7.1-3.

Table 7.1-3 Latest Urban Transport Indicators in Selected Region in Japan

Name of Mass Transit	Location	Route Length (km)	Daily Passengers Volumes per route km	Mode Type	Train Coposition	R/W
Oedo line	Tokyo	40.7	19,000	Light Metro	8@LIM	underground tunnel
Shinjuku line	Tokyo	23.5	28,000	Metro	10@Metro	underground tunnel
Tozai line	Tokyo	30.8	42,000	Metro	10@Metro	underground tunnel
Chiba city liner	Chiba city	15.2	2,000	Monorail (Suspension type)	2@L-mono	elevated exclusive guideway
Tokyo monorail	Tokyo	17.8	7,000	Monorail (Straddle type)	6@L-mono	elevated exclusive guideway
Tama monorail line	Tokyo	16	7,000	Monorail (Straddle type)	4@L-mono	elevated exclusive guideway
Okinawa yui rail	Naha city	12.9	2,000	Monorail (Straddle type)	2@M-mono	elevated exclusive guideway
Saitama new urban transport	Saitama city	12.7	3,000	AGT	6@AGT	elevated exclusive guideway
Yokohama sea side line	Yokohama city	10.6	4,000	AGT	5@AGT	elevated exclusive guideway
Yurikamome	Tokyo	14.7	6,000	AGT	6@AGT	elevated exclusive guideway
Toneri liner	Tokyo	9.7	6,000	AGT	5@AGT	elevated exclusive guideway
Waseda tramway	Tokyo	12.2	4,000	Tram	1@Tram	Road in mixed traffic
Hiroshima tram line	Hiroshima city	19.0	5,000	Tram	1@Tram	Road in mixed traffic

<Specifications of each model>

Rolling stocks Type	Car length(m)	Width (m)	Height (m)	Formal passengers capacity
L-mono (Large size monorail)	15.50	3.00	3.74	100
M-mono (Medium size monorail)	14.70	2.98	3.74	82
AGT (Automated Guide-way Transit)	9.00	2.50	3.30	75
LIM (Linear Induction Metro)	16.50	2.50	3.15	100
Metro	20.00	2.85	4.14	150

Note: Train Composition shows number of coaches and rolling stocks type.

Source: Railway Statistics Yearbook (2011)

(2) Estimation of Public Transport Demand Potential in Phnom Penh

As for the system selection of mass transit system, the most important factor is future transport demand. In this regard, potential public transportation demand level should be clarified so as to determine the required transport capacity in general. Using the future Origin-Destination (OD) trip matrix in 2035, which is tabulated by existing transport mode, trip aggregation is carried out based on the following assumptions:

- Passenger trip catchment areas for mass transit is assumed to be within the radius of 500 m and passenger trip catchment areas for feeder bus is assumed to be a belt area of 300m wide.
- Potential public transport demand is calculated assuming following diversion rate by trip mode:

$\text{Potential public transport volume} = \text{walk trip} \times 0\% + \text{motorcycle trip} \times 30\% + \text{Car trip} \times 30\% + \text{Para-transit trip} \times 100\%$

- c) In order to estimate demand flow by direction, the afore-mentioned transport corridors are divided into route segments as shown in Figure 7.1-4, and potential public transport demand is aggregated by route segments assuming stations of mass transit route and feeder transport routes.
- d) Each route segment is defined as follows:
- Segment 1: from Grand Phnom Penh International City (GPPIC) to Phsar Thmei
 - Segment 2: from Chaom Chau roundabout to Phsar Thmei along Russian Blvd.
 - Segment 3: from Chaom Chau roundabout to Phsar Thmei along Monireth Blvd.
 - Segment 4: from Takmao to Phsar Thmei

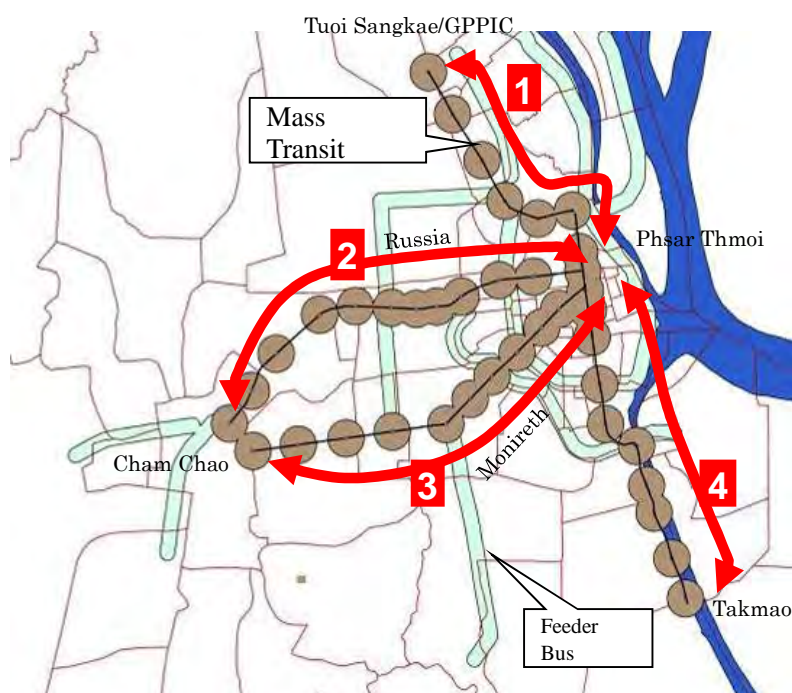

Source: PPUTMP Project Team

Figure 7.1-4 Outline of Potential Public Transport Demand Estimation

Table 7.1-4 Estimation Result of Potential Mass Transit Demand in 2035

Segment	Route length(km)	Minimum estimation scenario *1		Maximum estimation scenario *2	
		Daily passengers volume	Average Volume per route km	Daily passengers volume	Average Volume per route km
1	7.6	28,000	3,000	46,000	6,000
2	11.2	55,000	5,000	62,000	7,000
3	10.5	55,000	5,000	95,000	9,000
4	10.0	55,000	6,000	93,000	9,000
Total	39.3	193,000	5,000	316,000	8,000

Source: PPUTMP Project Team

*1: Only counting passengers within 500m catchments area

*2 Includes passengers using feeder transport means.

From the result above, the necessity of mass transit introduction is seen as following order.

- First priority line: Segment 2/Segment 4 with demand level of 5,000-9,000 passengers /day/km
- Second priority line: Segment 1/Segment 3 with demand level of 3,000-9,000 passengers /day/km

(3) System Selection of Trunk Public Transport in 2035

1) Adaptable Transport System by Demand Level

An adaptable transport system is selected, comparing with actual transport result (refer to Table 7.1-5). As shown below, systems except for Metro and Tram are considered to be adaptable for each route segment.

Table 7.1-5 System Selection based on Expected Demand Level

System type	Actual transport performance in Japan (passengers /day /km)	Adaptability	
Metro	20,000 to 40,000	Primary capacity is too large for expected demand level	▲
Linear Metro	7,000 to 19,000	Match to expected demand level	○
Monorail	2,000 to 7,000	Match to expected demand level	○
AGT	2,000 to 6,000	Match to expected demand level	○
Tram	around 5,000	Demand level might be within affordable range	○
LRT	Same as AGT, Monorail	Match to expected demand level	○

Source: PPUTMP Project Team

2) Choice of Right-of-Way

In order to successfully introduce mass transit system, it is essential to divert trips from private transport users (car, motorbike) to public transport system. This may be done by keeping the competitiveness of mass transit system with conventional road transport mode. Competitiveness of transport system can be measured by several evaluation factors, i.e. required time, cost, comfort and convenience. Among them the most notable factor is considered to be time. Since public transport requires various transitions such as access/egress, mode change and transit waiting extra time is added to one's trip. Depending on trip condition, trip diversion cannot be expected. To clarify this situation, a simple model comparison is examined as follows:

Table 7.1-6 Comparison of Required Travel Time by Transport Mode and Trip Length

Trip length	System	carriageway (R/W)	Speed (km/h)	required time (min.)				Total
				In vehicle time	Access/Egress time	Transfer time	waiting time	
5km	Car	Road	15	20.0	0	0	0	20.0
	TRAM	Exclusive at grade	25	12.0	5	8	3	28.0
	BRT	Exclusive grade separation	30	10.0	5	8	3	26.0
10km	Car	Road	15	40.0	0	0	0	40.0
	TRAM	Exclusive at grade	25	24.0	5	8	3	40.0
	BRT	Exclusive grade separation	30	20.0	5	8	3	36.0
15km	Car	Road	15	60.0	0	0	0	60.0
	TRAM	Exclusive at grade	25	36.0	5	8	3	52.0
	BRT	Exclusive grade separation	30	30.0	5	8	3	46.0

Rating Good Fair Bad

Assumptions:
 Speed :average speed (car) commercial speed (TRAM)
 Transfer time: from feeder bus stop to TRAM station

Note: RT (Rapid Transit) includes Metro, Monorail, AGT and LRT(Light Rail Transit)

Source: PPUTMP Project Team

- A suggested by the table, applicable main line system requires exclusive grade separation in Right-of-Way category to secure better transport service quality, comparing with private car mode. In this regard, Tram and BRT are not recommended.
- On the contrary, selection of Right-of-Way type affects significantly the system introduction in terms of physical aspect and implementation cost.
- Table 7.1-7 shows the adaptability of each transit system from viewpoints of Right-of-Way characteristics.

Table 7.1-7 System Adaptability for Right-of-Way

Right-of-Way Type		On Surface	Elevated viaduct	Underground tunnel
Right-of-Way Feature	Spatial requirement	Basically, R/W is secured in mixed traffic. Only LRT can accept.	Partial road capacity is lost due to the space for construction of viaduct column.	No interference with surface traffic.
	Infra cost	Requires small extra cost for track furnishing	Requires significant infra cost for viaduct structures.	Requires huge infra cost for tunnel structures
Transit	Metro	▲	⊙	⊙
	Linear Metro	▲	⊙	⊙
	Monorail	▲	⊙	△
	AGT	▲	⊙	○
	LRT	○*1	⊙	⊙

Note: Symbol: ⊙=Desirable, ○=Applicable, △=Not desirable, ▲=Impossible

*1: In case of transit mall

Source: PPUTMP Project Team

- It is considered that Right-of-Way for mass rapid transit system should be secured by grade separation type (elevated/underground) because it enables to maintain high competitiveness of mass transit against private traffic mode such as car, except for special cases such as “Transit mall scheme”. Underground Right-of-Way is most desirable from viewpoints of possibility for coexisting with surface traffic; however, its huge infrastructure cost may not overcome hesitations for its application.
- In this project, it is assumed that elevated type is selected as basic Right-of-Way in urbanized area and underground Right-of-Way is exceptionally applied in designated districts (Monivong and Russian Blvd., etc.) where renowned cityscape should be maintained.

3) System Selection and Route Formation for Trunk Public Transport

From viewpoints of transit operation, a transit route passing through urban central station is better than a transit route terminating at urban central station because of fewer off-duty trains during peak hour period. Therefore, the transit route should be made by combining several route segments. Regarding demand level by each segment, segment 3 and segment 4 show higher demand while segment 1 and segment 2 show lower demand. In this connection, combining segments 3 or 4 a main section and maintaining the rest as dependent sections are considered to be effective.

Based on the above and the required Right-of-Way, the trunk public transport system in 2035 is proposed as follows:

- Line1: Connecting segment 2 and segment 4, the first section is from Phsar Thmei to Chaom Chau roundabout along Russian Blvd. Second section is located between Takmao to Phsar Thmei (CBD station) of which Right-of-Way might be partially underground. Eligible mode for this line are AGT, LRT and Linear Metro. As its Right-of-Way, an underground structure is adopted for the area within Inner Ring Road (IRR) while an elevated structure is used for the section other than the above.
- Line2: Connecting segment 1 and segment 3, the line runs from GPPI to CBD station (Phsar Thmei) and stretches along Monireth Blvd. to Chaom Chau roundabout via the south of airport (Veng Sreng Road). Eligible modes for the line are AGT, LRT and Linear Metro. The line crosses with line 1 at CBD station.

4) Stage Development Plan for Trunk Public Transport System

The implementation of mass transit system project requires a considerable period for its planning, for conduct of feasibility study and for construction. In addition, considering the project scale with total route length of 39 km, budget constraints might become serious issues. Therefore, development of trunk public transport system should be done by stages, considering transport demand growth and investment balance.

- From the viewpoint of demand intensity, most critical is segment 4. In this segment, even the current public transport demand potential seems to exceed bus transport capacity; thus, mass transit introduction is desirable. However, since currently no formal public transport system exists, bus transport system development is necessary as a practical solution. A city-wide bus network is to be completed up to 2020 (mid-term).
- After that, in the long-term, around 2025, the mass transit introduction for segment 2 or 3 is to be implemented. In accordance with mass transit introduction, the bus route network should be reorganized to support feeder transport network of mass transit route.
- During 2025 to 2035, the other 3 segments will be implemented and the whole trunk public transport network will be completed.

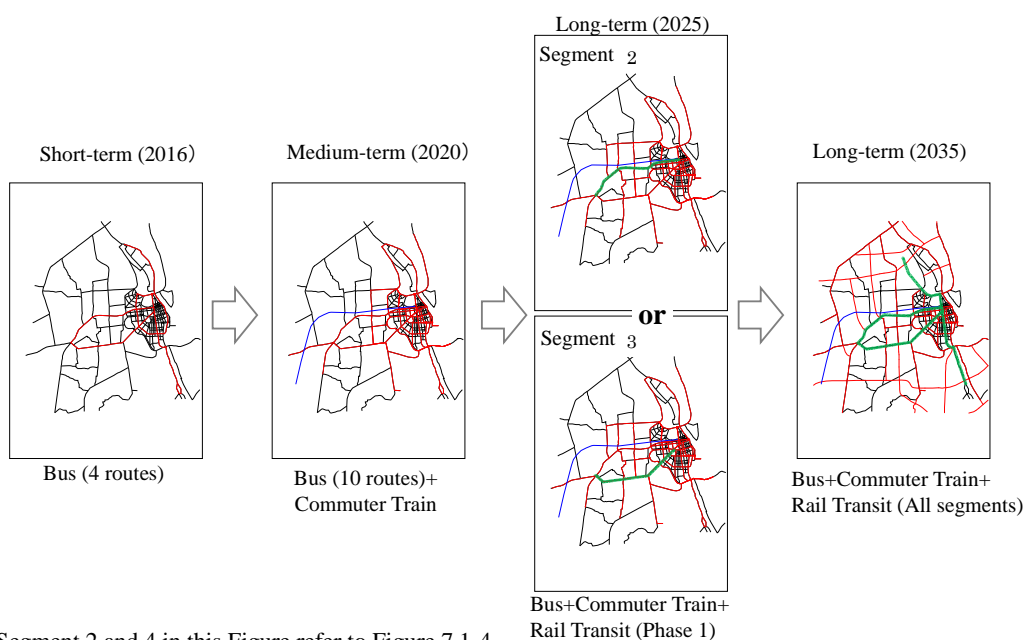

Note: Segment 2 and 4 in this Figure refer to Figure 7.1-4.

Source: PPUTMP Project Team

Figure 7.1-5 Staging for Public Transport Network Development

7.1.5 Countermeasures for Para-Transit

It is recognized that the public transport system consists of not only a main transport line (generally mass transit system) but also a supplementary transport system which collects and distributes transport demand from/to individual traffic zones. Even if there were a mass transit system in Phnom Penh, it would not be able to serve the entire public transport need of the city without a feeder transport system. In this regard, para-transit system like motodop can be adopted as a feeder transport for main public transport under certain regulation

/license scheme on service area/business rule. In fact, such a concept is realized in urban public sector, e.g., the Soi Bike (bike-taxi system in Bangkok), which is applied for access/egress transport between trip origin points and urban railway (BTS) stations and operated under an official transport scheme.

A current commuting means for suburban factory employees is small-sized trucks without such parts as seats and a roof. So, it is urgent to improve this situation in terms of passenger safety and comfort. In this regard, a para-transit system which is operated in suburban area of Thailand and is equipped with benches and roof top evolved from small trucks, so called “Songthaew”, which seems to fit as a model for its countermeasure.



Source: PPUTMP Project Team

Figure 7.1-6 Soi-bike in front of BTS Station in Bangkok

7.1.6 Effective Use of Existing Public Transport Such as Railway and Water Transport

In terms of transport facilities, there are railway and water transport facilities existing in Phnom Penh. However, as a part of urban transport system, these modes are hardly recognized as such by the people.

Concerning railway, it is in the midst of being restored as freight railway by concession scheme. However, it is proposed to introduce commuter rail services using existing rail tracks because new station development is planned in the Phnom Penh Special Economic Zone (PPSEZ) in which employment for 20 thousand people is to be generated in the future after the completion of the current rehabilitation project by ADB for southern railway section. In addition, Central railway station is recognized as an important historical heritage of Phnom Penh and has symbolic value as gateway of Phnom Penh. As described in the preceding section, the crossing point of Monivong and Russian Blvd. will become a hub of trunk public transport network. This situation can be an opportunity to activate existing railway facilities. If long distance passenger service could resume from Central station, it can provide a new perspective of comprehensive mode interchange area development integrating inter-city transport node with urban transport node.

River utilization as urban transport might be considered by peculiar location factor of Phnom Penh, i.e., historically Phnom Penh City has been developed in close relation with Mekong, Tonle Sap and Tonle Basac Rivers. Although water transport is restricted to operate only along rivers, it requires a relatively small infrastructure cost for network expansion and is environmentally friendly. Comparing to other

modes, this feature is considered to be an advantage in connecting with surrounding areas of Phnom Penh, taking into account that there are few cross-river points by bridge in Mekong River basin.

7.1.7 Mode Interchange Area Development

(1) Basic Planning Direction

A mode interchange area is a transfer point between several modes of transport. The transfer is the most serious weak point of public transport systems. Therefore, the key to the success of a public transport system is how to develop a convenient mode interchange area. Urban development with facilities allowing transfers within modes such as a rail transit station and rail transit/bus terminal, especially in the suburban area, can pave the way to a new type of urban development concept in Phnom Penh such as a transit-oriented development (TOD).

Based on the above discussion and the proposed public transport system in this master plan such as rail transit, commuter train, BRT and bus, the planning of a mode interchange area is discussed below.

(2) Functions and Facilities of Mode Interchange Area

Functions and facilities for a well-functioning mode interchange area are as follows:

- Efficient and convenient space for mode of transport using the mode interchange area

A well-developed motorcycle and car parking, and taxi and para-transit pools should be provided to cope with the passenger demand. These include park-and-ride parking, cycle-and-ride parking, taxi and para-transit pools.

- Smooth transfer

This means short transfer distance, providing the most intelligible route and well-connecting the transfer between transport modes. Aids to smooth transfer are sidewalks, barrier free if necessary, and elevators/escalators where necessary.

- Comfortable clean and safe waiting spaces and other amenities

It is necessary to develop waiting spaces that are comfortable and can protect against sun and rain and are well-lighted to make waiting passengers feel safe especially at night. In addition, it is important to provide understandable information for all modes of transport using the mode interchange area. Other passenger amenities include sheds, street furniture, information board for public transport network, bus location system and toilets.

- ▲ Regional/district center

There are spaces and facilities that can be developed where people can gather, do business or just spend time and where extensive information about regional/district daily life and transport is made available. These are public facilities such as Khan's branch office and commercial/business facilities.

Note: ■ means necessary for all mode interchange areas; ▲ means consider to develop if necessary.

Based on the above directions, the interchange types for the public transport modes planning in the future Phnom Penh may be categorized into 10. Among these types, three are typical ones with proposed locations, and their conceptual designs, mainly showing the flow pattern of primary modes of transport including pedestrian flow, are shown in Figure 7.1-6. Obviously, the development of an efficient and comfortable mode interchange area will persuade people to shift from private mode to public transport, thus reducing road traffic.

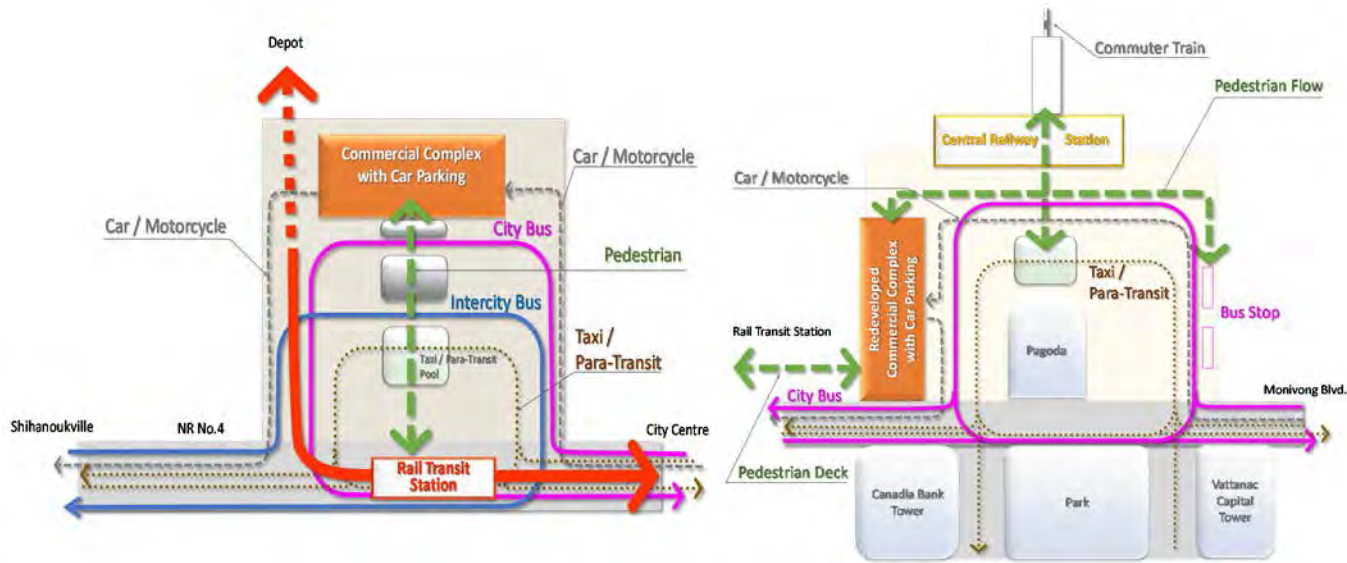

Rail Transit Terminal

Central Railway Station Plaza

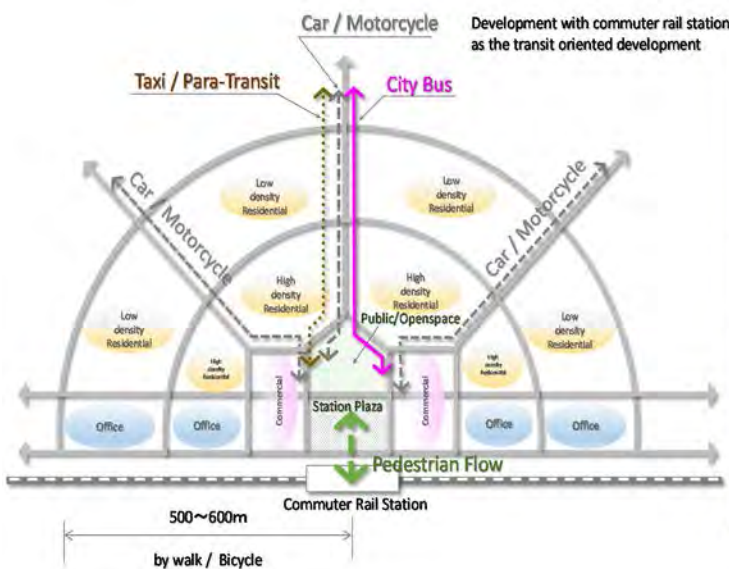

Commuter Rail Station with TOD

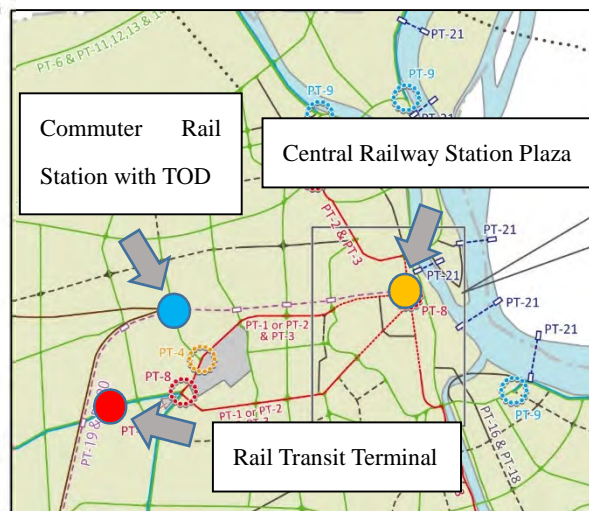

Location Map

Source: PPUTMP Project Team

Figure 7.1-7 Conceptual Design of 3 Mode Interchange Areas

7.2 Road Network

7.2.1 Planning Approach

(1) Basic Standpoint of PPUTMP Team on Road Network Planning

- a. The road network plan is developed with the following objectives:
 - To cope with the traffic congestion problems in the future;
 - To support the public transport development by providing adequate space for operating bus or mass transit services;
 - To develop trunk road framework in accordance with the future urban structure; and
 - To improve the people’s mobility in the suburban area by increasing the road density.

- b. This is a master plan study; therefore the network to be proposed will only comprise arterial and collector roads.
- c. Generally the future road network for 2035 in the Project area will be formulated based on the road network plan in 2020 MP, which has already been approved by the City Council.
- d. Since the 2020 MP was developed before the expansion of the city boundary, several roads in the suburban area should be added in order to support the new urban development.
- e. Special attention will be paid to the large scale-development projects of housing and transport and industrial facilities such as new port, new airport, new logistic center, PPSEZ, and the number of urban development projects in Phnom Penh.
- f. It will be also taken into account to minimize the relocation of private houses caused by new road construction or bottleneck intersections newly created by road development.

(2) Road Network Pattern

The present road network pattern in the Project area shows a radial/ring road pattern by and large, while the network in the district level shows a grid pattern.

Accordingly, the future network plan will be developed in accordance with these patterns.

(3) Design Standard of Roads and Bridges

Most of the existing roads in Phnom Penh are not corresponding to the Design Standard on roads and bridges in Cambodia, since the Design Standard was set forth after the central area had been built up.

The newly proposed roads in this project are planned in accordance with the Design Standard as much as possible, taking into account the relevancy of its application. For the typical cross section, the widths for vehicle carriageways as well as side walk will be taken in accordance with the Design Standard.

(4) Road Density

The road density in the central area inside the IRR is sufficiently high when compared to the other cities in neighboring countries like Kuala Lumpur, Singapore, Hong Kong, Bangkok and Hanoi etc., while that in the sub-urban area is still low (city centre: 12.2 km/sq. km and suburban area: 1.6 km/sq. km).

The future population will mainly grow in the suburban area toward 2035, where more road developments will be required for enhancing mobility and sustaining the suburban life.

The future road network for 2035 will be planned by setting the road density target roughly estimated by using the relationship with the future population density.

7.2.2 Traffic Demand and Capacity

Table 7.2-1 shows the V/C ratios in the cases that the traffic demand in 2012 and that in 2035 are assigned to the existing trunk road network.

- a. The traffic demand is already exceeding the traffic capacity at the corridors, S1 (Monivong & Norodom), M1 (Monireth) and R2 (Monivong Bridge).
- b. In 2035, the traffic demand is predicted to exceed the capacity at almost all the corridors.
- c. Particularly the V/C ratio is high at M1 (Monireth), R1 (Chrouy Changva Bridge), S1 (Monivong & Norodom), R2 (Monivong Bridge), S2 (NR2) and W1 (Russian Blvd. & Kampuchia Krom). Accordingly, the traffic capacities for these corridors should be increased.

Table 7.2-1 Comparison of Traffic Demand and Traffic Capacity

Corridor	Present Network			Do Nothing Case		
	Capacity (pcu/day)	Traffic Volume in 2012 (pcu/day)	v/c Ratio	Capacity (pcu/day)	Traffic Volume in 2035 (pcu/day)	v/c Ratio
N1	119,700	103,403	0.86	119,700	207,344	1.73
N2	58,600	19,035	0.32	58,600	42,214	0.72
N3	42,400	17,965	0.42	42,400	39,588	0.93
N4	34,200	21,962	0.64	34,200	40,005	1.17
W1	91,800	84,292	0.92	91,800	166,453	1.81
W2	150,100	66,259	0.44	150,100	166,927	1.11
W3	95,400	60,539	0.63	95,400	117,982	1.24
W4	53,000	32,895	0.62	53,000	58,859	1.11
S1	103,300	108,040	1.05	103,300	227,553	2.20
S2	73,200	55,883	0.76	73,200	145,143	1.98
S3	49,800	26,762	0.54	49,800	67,504	1.36
M1	53,800	57,712	1.07	53,800	141,838	2.64
M2	58,500	43,845	0.75	58,500	75,318	1.29
R1	34,400	32,342	0.94	34,400	85,117	2.47
R2	70,300	74,952	1.07	70,300	149,487	2.13

Source: PPUTMP Project Team

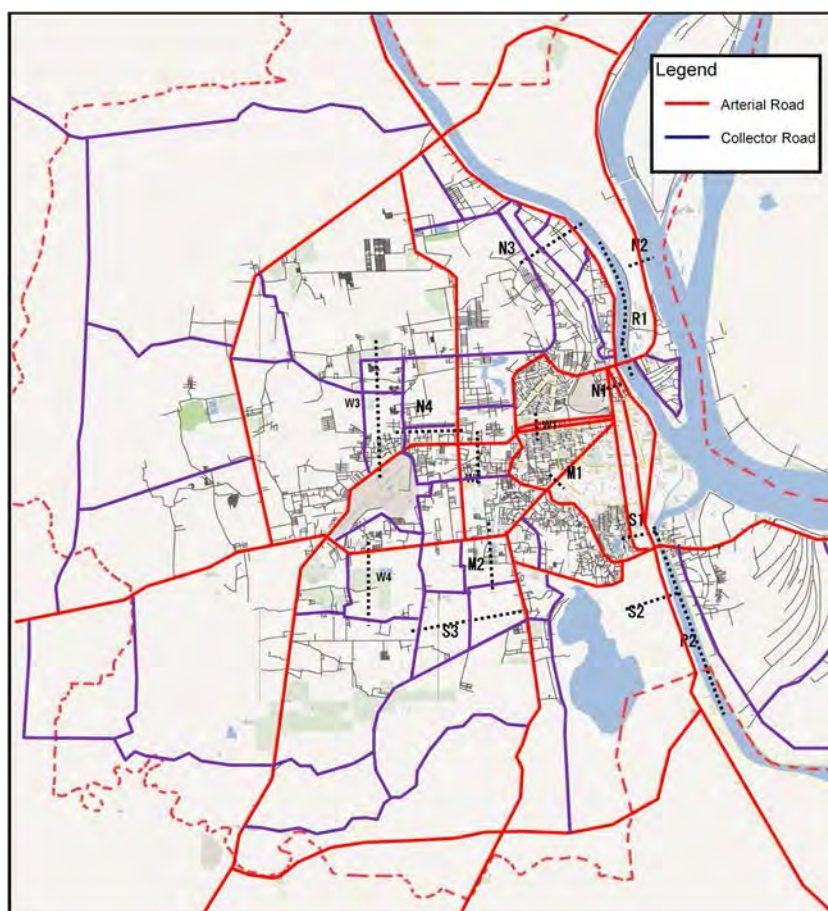

Source: PPUTMP Project Team

Figure 7.2-1 Transport Corridors to Promote Balanced

7.2.3 Road Projects Under Construction or in Committed Stage

The following projects are currently under construction (as of October 2014), or committed according to the Ministry of Public Works and Transport (MPWT) and DPWT.

1. 2nd Chrouy Changvar Bridge (completed by DPWT)
2. East River Bank Road (Chrouy Changvar District) (completed by DPWT)
3. Stueng Mean Chey Flyover (completed by DPWT)
4. Toul Kork Flyover (on-going by DPWT)
5. Takhmau – Preak Samroang Bridge and the Connection Road to NR1 (on-going by DPWT)
6. Middle Ring Road Project (NR1 – NR2) (on-going by DPWT)
7. NR6 (on-going by MPWT)
8. Hanoi Road (on-going by DPWT)
9. Veng Sreng Road (on-going by DPWT)
10. Hun Sen Road (on-going by DPWT)
11. Outer Ring Road (on-going by DPWT)
12. Rehabilitation and Widening of NR42 (planned by DPWT)
13. NR5 (on-going by MPWT)
14. Camko City Road / Grand Phnom Penh Road (on-going by DPWT)
15. PPSEZ Road (completed by private sector)

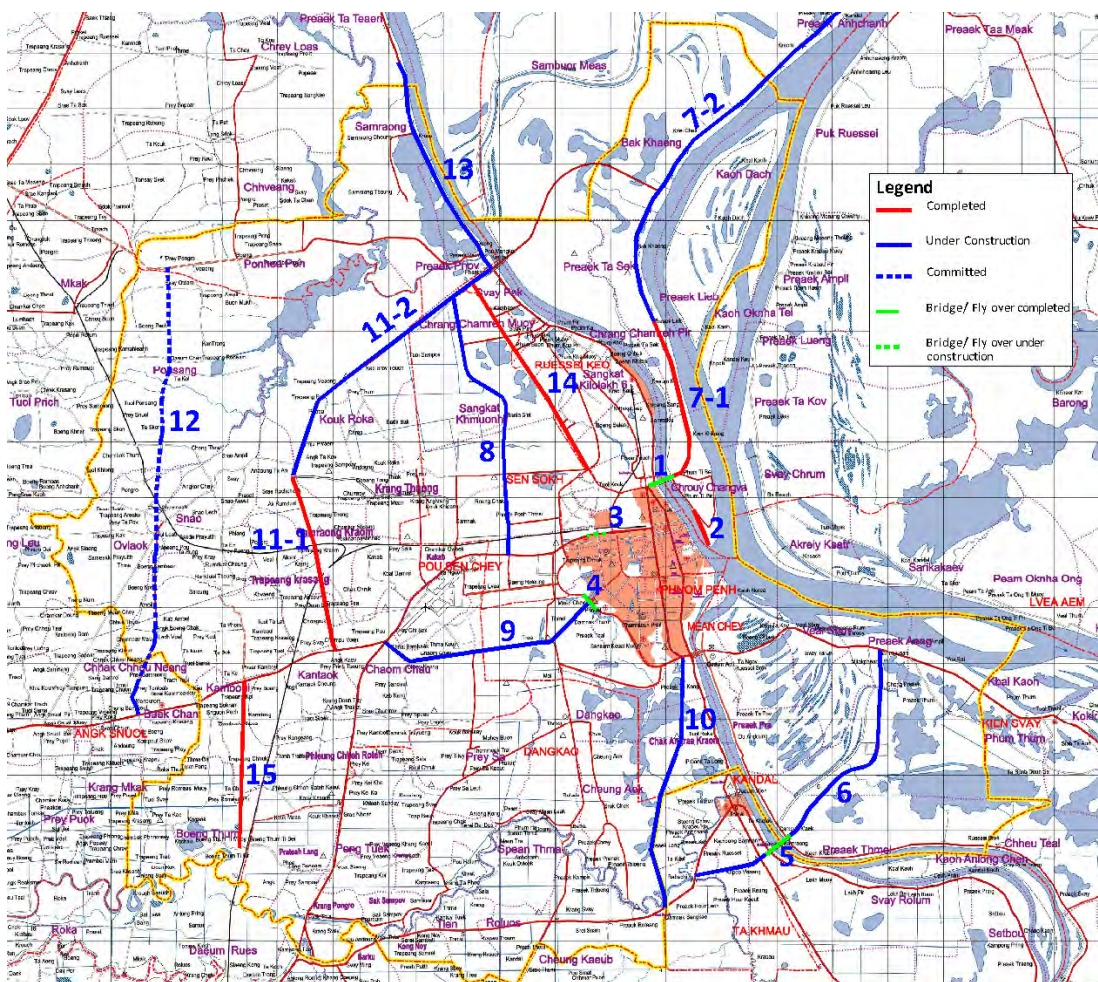

Source: PPUTMP Project Team

Figure 7.2-2 Road Projects Under Construction or in Committed Stage

7.2.4 Preparation of Road Network Proposed for 2035

Completion of the proposed trunk road network is the fundamental framework of the urban transport system and actual construction takes time. And most important factor to materialize the trunk road system is to secure the right-of-way of the road.

(1) Inter-regional Road

As an inter-regional road related to Phnom Penh, one-digit national roads such as NR1, NR2, NR3, NR4, NR5 and NR6 have the most important role in the future. The improvement or widening plans of these national roads are shown either in the "Follow-up Study on Road Network Development Master Plan (JICA, March 2009) or "Data Collection Survey on Trunk Road Network Planning for Strengthening of Connectivity through the Southern Economic Corridor" (JICA, March 2013).

According to these reports, all of them except NR3 have already been developed or are to be developed by 2020 as a 4-lane road at least in the suburban area of Phnom Penh. NR2 up to Ta Khmau and NR4 for 20 km section are already 4 lanes, while widening works of NR5 and NR6 are undertaken at present.

(2) Road Network Development in Phnom Penh

Based on the road development policy, the road network for 2035 was prepared from the following viewpoints:

- To complete the ring and radial road network pattern
- To strengthen the East – West transport corridor where the rapid urbanization is currently proceeding
- To support the new sub-centers particularly located at North and South of the Central area as identified in the urban structure in 2035
- To mitigate the traffic congestions at present as well as that anticipated in the future
- To support the development of public transport including bus services covering all the Project area

a) Road Network in the Central Area

As the Central Area is mostly built up already and has sufficiently high road density, there is no new road development plan except for the urban development areas such as Boeng Kok.

As for some existing roads, widening is proposed in this project: The Inner Ring Road (IRR) will be widened from 2 to 4 lanes in the northern half and a part of south section. In addition, the widening of the section from Russian Blvd. and Toul Kork and the widening of Monireth to 6 lanes within the ROW are proposed.

The missing links for the section between St.608 – St.610 and between St.430 and St.261 are also proposed to be constructed.



Figure 7.2-3 Proposed Road

Development Plan in the Central Area

52 Source: PPUTMP Project Team

b) Road Network Development in the Sub-urban Area

1. Ring Roads

In addition to the Inner Ring Road (RR-I), three more ring roads will be developed; namely, the Middle Ring Road (RR-II), the Outer Ring Road (RR-III) and the Outer-most Ring Road (RR-IV).

Middle Ring Road (RR-II)

The Middle Ring Road (RR-II) has been proposed by China, and currently, the Preak Samroan Bridge is under construction.

The plan intends to construct a new road from NR1 to Chaom Chao Road via above mentioned bridge and widen Hanoi Road and extend up to NR5 (the section from NR2 to NR5 is planned to be a 4-lane road.).

In this project, RR-II is proposed to be further extended to NR6 crossing the Tonle River as a 2-lane road (13.5m in width).

Outer Ring Road (RR-III)

The Outer Ring Road (RR-III) is proposed to start from NR1 near the New Phnom Penh Port, crossing with NR2 at about 3 km east of Cheng Aek Road, be aligned toward Northwest until NR3 at about 3 km from the junction point of NR3/NR4, and connect to Kob Srob Road, then to NR5 and NR6. This ring road is the one originally proposed by Korea, but the road alignment has been modified by slightly shifting to the north at the section between NR2 and NR3 in order to avoid the precious agricultural area. The carriageway width is planned to be 22 m for the section from NR21 to NR5, while the other sections are assumed to be 13.5 m in width. It will be operated and maintained under a build-operate-transfer (BOT) scheme after its completion.

Outer-most Ring Road (RR-IV)

RR-IV is the outermost ring road aligned at about 4 km to 10 km outside of RR-III. It is planned to be developed from NR1 at about 4 km south of New Phnom Penh Port to NR2 at around Preak Slaeng district and NR3 at around Trapeang Veang district; then it is aligned northward, and slightly eastside of NR42 in parallel and turns eastward near the north-west city boundary and reaches at NR5 and NR6 at several kilometers outside of RR-III. Accordingly, RR-IV is defined as a city boundary ring road and is expected to be used as a bypass road of the urbanized area. At the same time, it is expected to be a supporting road for the development of the surrounding area.

RR-IV is proposed as an ordinary arterial road with 10.5 m carriageway at the beginning; however, it will be converted to an expressway when the expressway network at national level is developed.

2. Radial Roads

As for the radial roads, the national roads NR1, NR2, NR3, NR4, NR5 and NR6 will be widened, as stated above to play important roles as suburban arterial roads in the future.

In order to enhance the East-West axis, the carriageways of Russian Blvd. and Veng Sreng Road will be widened within the Right-of-Way to cope with the traffic growth and function as a main public transport corridor in the future.

In addition, two new East-West arterials roads are proposed; one is located at the North of Russian Blvd, starting from RR-I at Toul Kok to RR-IV via Hanoi Road and RR-III. The other is planned at the south side of Veng Sreng Road and NR4 starting from NR1 to RR-IV, linking with vertical main roads like NR2, Cheng Aek Road, RR-II, RR-III, etc.

With regard to North-South direction, Hanoi Road and Hun Sen Blvd. will function as the arterial roads.

Hanoi Road will be widened to 4 lanes with a bike lane road. Hun Sen Road will be developed from the

southern end of Monivong Blvd to RR-III to function as a main corridor to/from AZ Green City.

3. Other Roads

The main road developments are intended to support the urban development projects mainly located at the suburban area.

In addition to several large-scale projects, a number of urban development projects are undertaken at present. As they will be new main traffic generation points, the road network developments in the following areas are proposed to cope with the future traffic demand and to support the urban development.

- Mean Chhey District including Chabar Ampov area (the area surrounded by NRI, RR-II and Tonle Basak River)
- Green City area
- Southern area of Chaom Chau
- Samraong Kraom Sub-Center area (Logistic Center)
- Krang Thnong urban development area
- Camko & Grand Phnom Penh area
- Chrouy Changvar area (including Garden City Preaek Phnov)

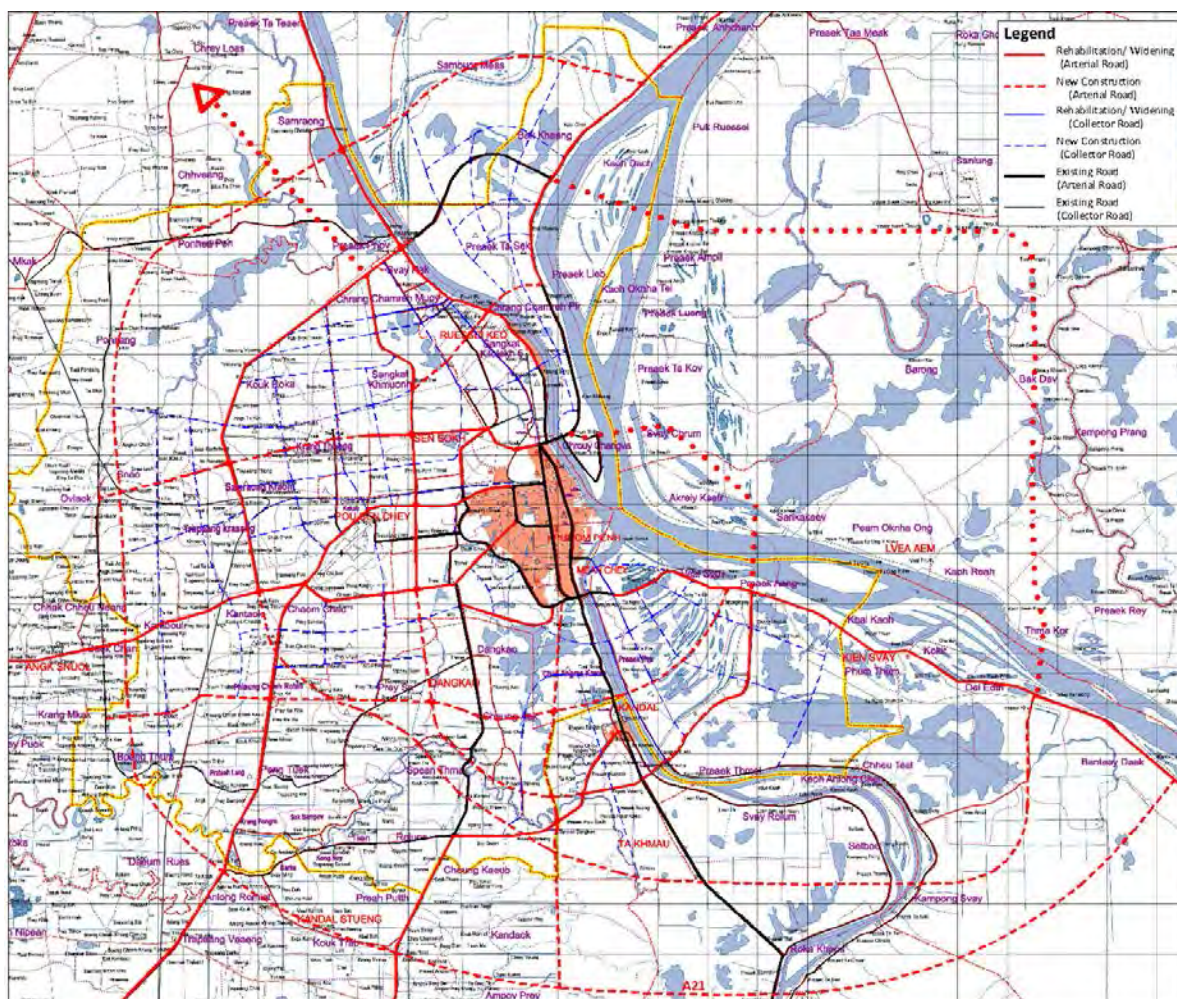

Source: PPUTMP Project Team

Figure 7.2-4 Proposed Road Network in the Suburban Area

7.3 Traffic Management

7.3.1 Overall Plan

A comprehensive traffic management is planned to maximize use of limited urban road space, to prepare a comfortable pedestrian space and to increase the convenience of the public transport.

With a comprehensive traffic management system combining several traffic management schemes, safe, comfortable and smooth transportation system is expected to be materialized in the dense city center.

In other words, implementation by mutual linkage of the following measures, which are triggered by traffic signal system upgrading (refer to Section 7.3.2), can establish a safe and smooth transportation system in Phnom Penh:

- (1) Improving problematic intersections together with traffic signal system upgrading (refer to Section 7.3.2);
- (2) Securing traffic safety and ensuring smooth traffic flow along one-way roads together with traffic signal system upgrading (refer to Section 7.3.2);
- (3) Developing on-street parking along local roads together with the introduction of the one-way system (refer to Section 7.3.2 and 7.3.3);
- (4) Developing on-sidewalk parking space using a part of sidewalk space along the trunk roads (refer to Section 7.3.3);
- (5) Looking into the possibility of improving the sidewalk by public side triggered by the traffic signal system upgrading (Control private use of the sidewalk space and restore the original function of the sidewalk) (refer to Section 7.3.4);
- (6) Safely continue the pedestrian network by installing pedestrian traffic signals and pedestrian crossing marking (refer to Section 7.3.4); and
- (7) Strengthening of the traffic safety education and traffic enforcement, which are essential for the efficient functioning of above measures (refer to Section 7.3.5).

A conceptual picture of the comprehensive traffic management scheme is provided in Figure 7.3-1. It shows that improvement in the traffic condition in the dense city center is materialized by all of the above measures when they come together much like pieces of a jigsaw puzzle, but unlike the pieces of a puzzle, each one individually works.

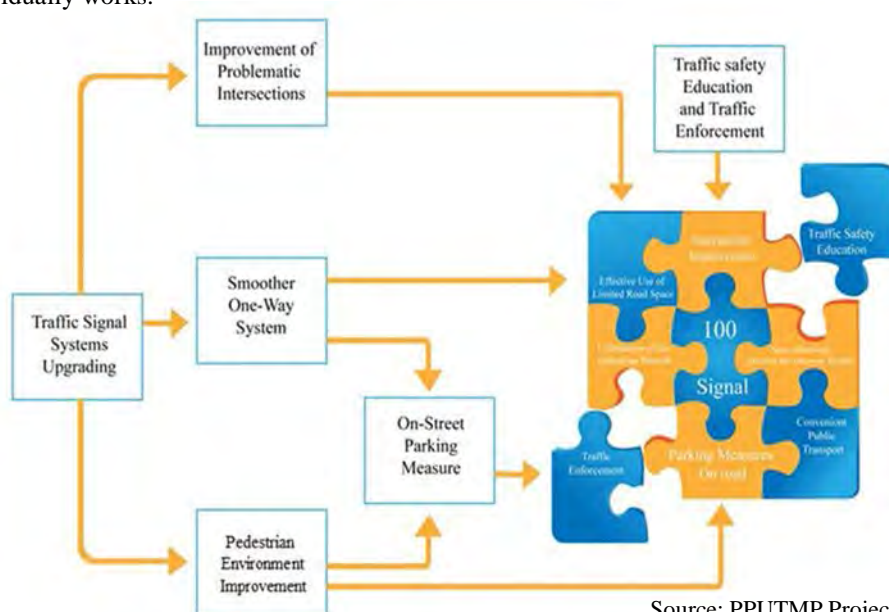

Source: PPUTMP Project Team

Figure 7.3-1 Conceptual Picture of Comprehensive Traffic Management System

7.3.2 Road Traffic Improvement Plan

(1) Major Problematic Intersections

Many problematic major intersections in the city have been improved under the “Phnom Penh City Urban Transport Improvement Project” and other projects. However, the following 3 major intersections are representative of intersections that still face major traffic issues.

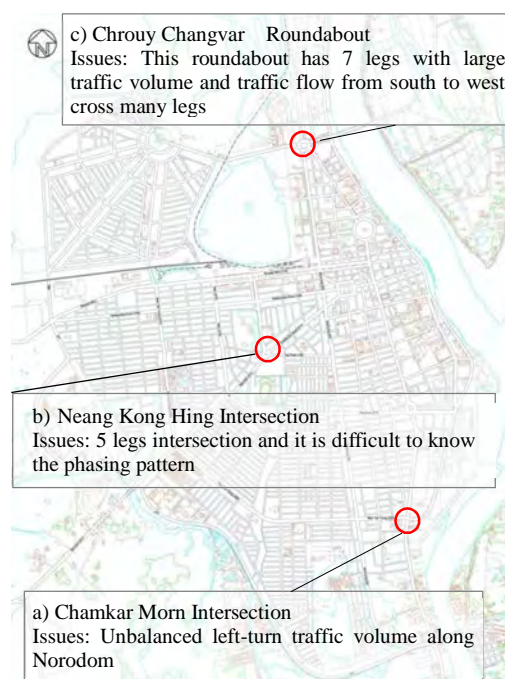

Source: PPUTMP Project Team

Figure 7.3-2 Location of the Major Problematic Intersections

1) Chamkar Morn Intersection

This is a signalized cross intersection with a 4-phase signal control plan. In spite of its signalization, traffic police is needed to direct traffic during the morning peak hours to avoid serious congestion from occurring. The existing signal control plan is thus given a thorough review to replicate the situations as if they are under the guidance of the traffic police. Results of the review concluded that a 5-phase control plan is necessary. With such an improvement, the need for a traffic police to be on site has become minimize.

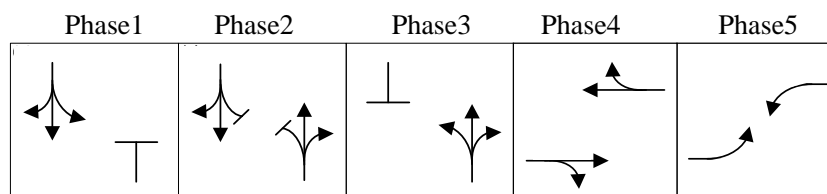

Source: PPUTMP Project Team

Figure 7.3-3 Improved Signal Control Plan at Chamkar Morn Intersection

2) Neang Kong Hing Intersection

This 5-legged cross intersection is under an existing and fairly efficient 4-phase signal control pattern. However, to further simplify the traffic movements within this intersection, traffic control measures may be applied to the relatively small traffic volume entering Charles de Gaulle Blvd. This will then enable some changes to the traffic lane operations. Traffic congestion at this intersection can then be largely abated to an acceptable level. However, looking at the conditions of building around this intersection, there is no space for any road width widening and any improvement measures have to be carried out within the existing road space.

It is concluded that major changes to the existing configuration and operation of this intersection will be difficult. The applicable solution is to implement certain traffic control measures to some entry points of the intersection. This would help to mitigate and reduce the level of traffic congestion.

3) Chrouy Changvar Intersection

To resolve the problems brought on by multiple merging points and longer travel distance on the IRR and the need for a smoother traffic flow, the underground passageway proposal was considered to be a superior alternative. With this proposal, the merging of IRR traffic with local traffic can be avoided. Hence, many potential traffic conflicts can also be avoided by the weaving traffic within the roundabout. The function of IRR can be significantly strengthened. Finally, since IRR traffic is segregated from the local traffic, the proposed underground passageway can also contribute to a safer and smoother traffic condition.

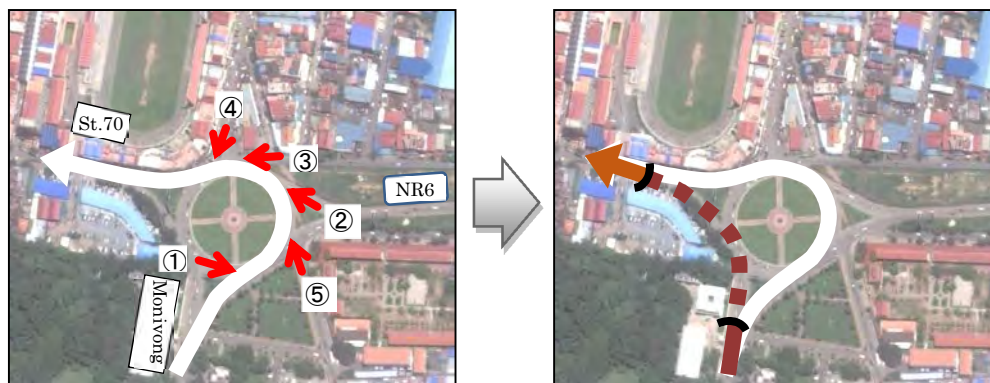

Source: PPUTMP Project Team

**Figure 7.3-4 Proposed Improvement Measure at Chrouy Changvar Roundabout
(Underground Passageway)**

(2) Signal Control Improvement Plan (Traffic Signal Control System)

1) Necessity

Currently there are more than 60 intersections in Phnom Penh City that are installed with traffic control signals. However, most of them are isolated signal controls operating with fixed timing plans regardless of the traffic demand conditions, making them rather inefficient in controlling the traffic.

To cope with the worsening traffic conditions brought about by future traffic demand increases, more efficient traffic signal system is required. Because of the limited capability of the existing equipment, upgrading them so as to incorporate more advanced functions is not possible and thus a new set of signal control system must be introduced.

Area Traffic Control (ATC) system is a system where the signal controls are all done by using a computer system. All the traffic signals at intersections are directly and centrally controlled by a computer system located in a traffic control centre. Signal timings at all signalized intersections are optimized to handle the prevailing traffic demands which are constantly measured by the vehicle detectors placed at strategic locations within the road network. The traffic conditions in Phnom Penh have reached a level that calls for the introduction of an ATC system to effectively manage the overall city-wide traffic demand on its road network.

2) System Composition

An ATC system basically comprise a signal control computer system installed in a traffic control center, signal and signal control equipment at each of the intersections, vehicle detectors that measure the prevailing traffic conditions and lastly, the various cables that link up all these equipment and components.

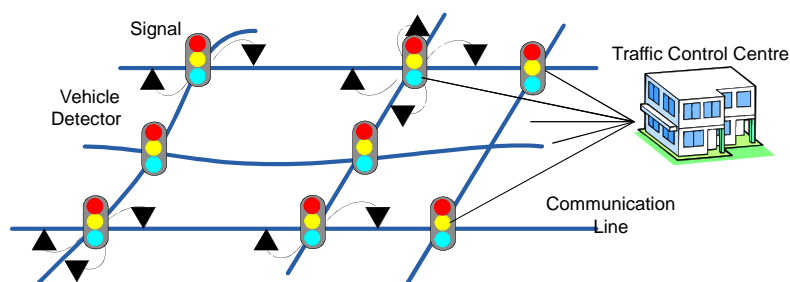

Source: PPUTMP Project Team

Figure 7.3-5 Basic Concept and Configuration of ATC System

3) Expected Benefits of Introducing an ATC System

The following are some of the expected positive effects of introducing an ATC System:

- Efficiency in traffic operation (reduction of stopping, delays and increase in overall travel speed)
- Improved traffic safety (reduction of traffic accidents)
- Reduced fuel consumption and hence reduced CO2 and emissions of other pollutants

4) Selected Intersections for the Proposed ATC System

Presently, there are a total of 69 signalized intersections in Phnom Penh. Out of these, 61 locations and another 31 new intersections that require installation of new signal control equipment will be incorporated into the target control area of the proposed ATC System.

5) Traffic Surveillance (CCTV) Camera System

As part of the ATC system, a Traffic Surveillance System using 26 CCTV cameras is also proposed.

Locations of these CCTV cameras within the traffic control area are shown in the figure below.

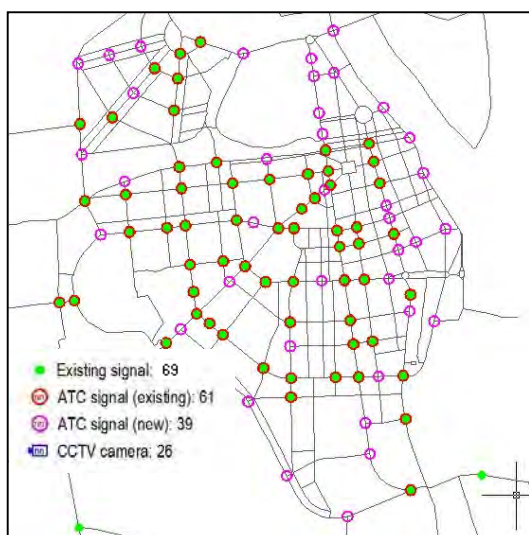

Source: PPUTMP Project Team

Figure 7.3-6 Target Signalized Intersections for the Proposed ATC System

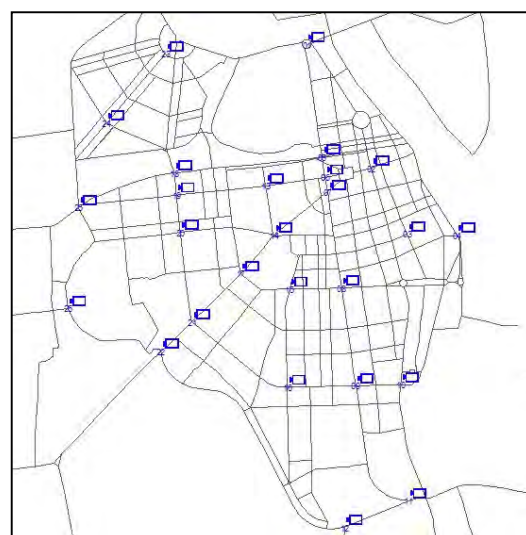

Source: PPUTMP Project Team

Figure 7.3-7 Target Signalized Intersections for the Installation of CCTV Cameras

6) Organization Setup

The ATC system requires competent staff with specialized knowledge for its introduction, operation and maintenance. The work demand skills and know-how that are much higher than those required for managing the existing signal control equipment. The current management and operational capability of the Public Lighting Division of DPWT will not be sufficient to operate and manage the proposed ATC system. Capacity building is thus required for this agency.

7) Plan for the Introduction of the ATC System

Plan and time schedule for the introduction of the proposed ATC system is shown in the figure below.

Table 7.3-1 System Implementation Schedule

	2014	2015	2016	2017
Traffic survey and system design		██████████		
Tender document preparation		██████		
Tendering and contractor procurement		████		
Manufacturing, database development, factory test			██████	
System construction, testing and commissioning			██████████	
Training-On-the-job System training				██████

Source: PPUTMP Project Team

(3) Intersection Improvements

Intersection is a location where traffic streams intersect each other and the service level of a road is often dictated by the traffic processing at the intersection. Furthermore, such traffic processing performance at intersection in turns also affects largely the operational efficiency of the signal control equipment. The followings are some of the traffic operational improvement measures applicable to intersections:

Note: Shaded works in the Figure are expected in the grant aid project.

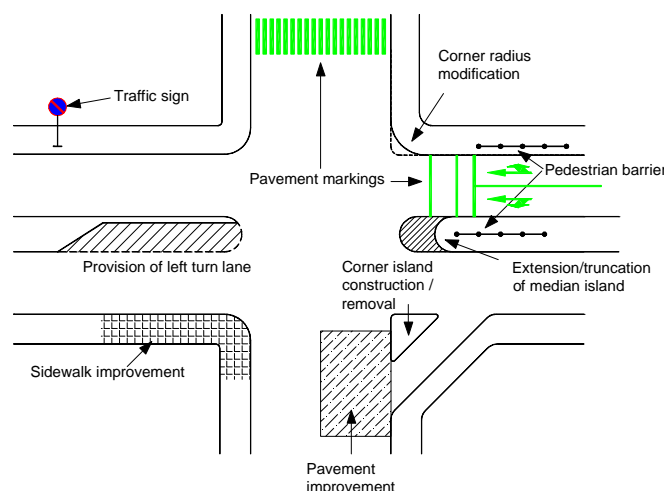

Source: PPUTMP Project Team

Figure 7.3-8 Intersection Improvement Measures

(4) One-way Traffic System

1) Planning Direction

The city of Phnom Penh is facing a worsening traffic congestion problem that is chiefly due to the steady increase of vehicle usage and reduced road capacity brought about by widespread roadside parking. In addition, illegal and indiscriminate parking of vehicles on pedestrian sidewalks and roadways have threatened the safety of pedestrians. Solutions to all these urban transport problems are therefore urgently needed. New transport facilities development is facing space constraint in the city center, hence, more efficient utilization of the existing road space is the key to solve these various problems. Along narrow streets, curbside parking has resulted in difficulty for opposing traffic streams to pass through, thus creating serious traffic congestions. To overcome this problem, one of the solutions is to convert such narrow streets into one-way traffic streets. This measure can help in more efficient usage of the limited road space by increasing its operational capacity for a smoother traffic flow while reducing traffic accidents.

For this reason, in the 1st Public Experiment conducted under this Project, a one-way traffic system and parking countermeasures to free up pedestrian walking space for tourists and pedestrians were implemented in a section of the Tourist Area. With good results from such experiment, the introduction of the one-way traffic operation system to the entire city center focusing on the highly trafficked Tourist Area is being examined.

2) Basic Concept on the Introduction of One-Way Traffic System

Basic Functions of a One-Way Traffic System

The following are the basic functions of a one-way traffic system for the city center:

- One-way traffic system capable of increasing the traffic processing capacity of narrow and congested streets; and
- One-way traffic system capable of enhancing or complementing the operation and functions of a future urban public (bus) transport system.

In principle, one-way traffic system will not be introduced to the major arterial roads in the city. In the case of districts, the following conditions for one-way measures are proposed:

- All the existing one-way traffic streets are to be retained as they are;
- The existing routes are basically extended or expanded to those routes or areas included in the Public Experiment Study Area;
- Streets that are close-by, parallel and of similar class and length can be paired up;
- Any extension of route should not be too short and in principle should function as the connecting road between arterial street;
- Each pair of one-way streets must be basically within 300 m of each other;
- Routes are selected only if they do not cause exceptionally long detours;
- Routes that may cause further complication to the travel pattern will not be selected; and
- Narrow streets or road sections which attract large traffic volumes of people and vehicles such as roadside wet market should not be considered.

3) Proposed One-Way Traffic System

By referring to the above basic concept and functions, a one-way traffic system is proposed for the city center of Phnom Penh.

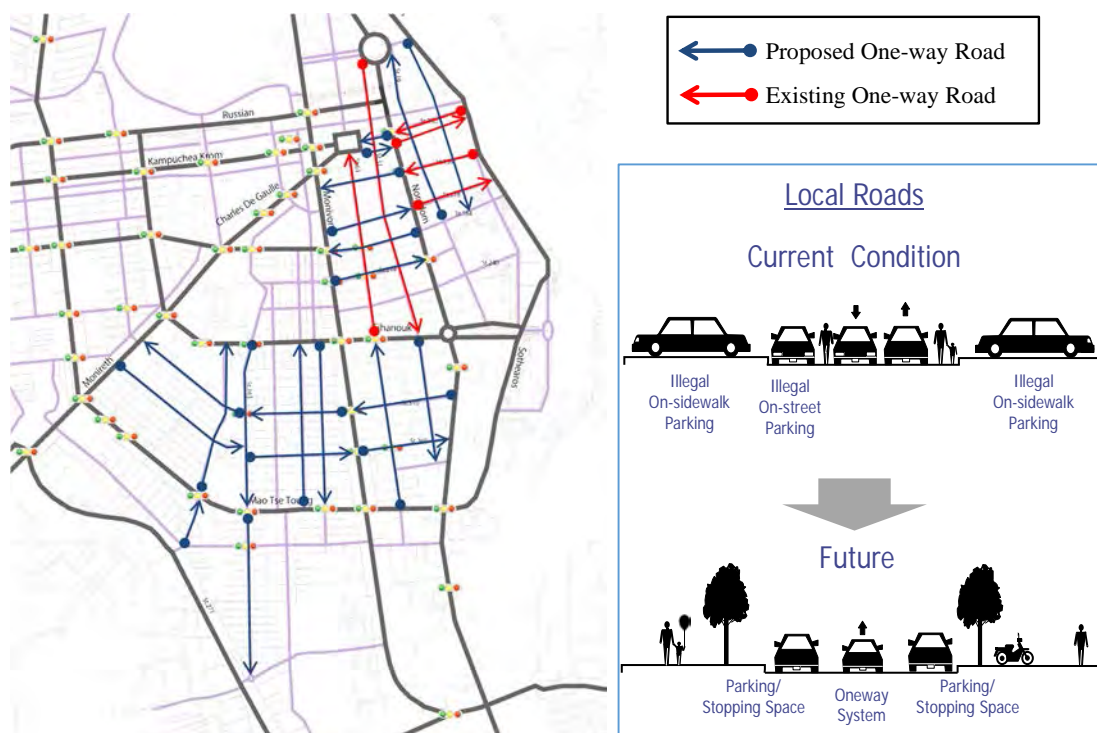

Source: PPUTMP Project Team

Figure 7.3-9 Proposed One-Way Traffic System for Phnom Penh City Center

7.3.3 Parking Measures

Examining the current parking supply balance, there is an overall shortage of about 11,600 (11,620=15,560-3,940, refer to (A) and (G) in Table 7.3-2) lots for motorcycle parking and another about 5,800 (5,843=8,408-2,565, refer to (A) and (G) in Table 7.3-3) lots for passenger cars within the city center. Using the current parking demand as a base, the demand for parking for the future planning years in 2016, 2020 and 2035 are forecasted. Future parking countermeasures are proposed to mitigate the increases in demand taking into consideration the features of urban transport in Phnom Penh.

(1) Supply unable to Meet Future Demand for Parking

The future parking demand is basically forecasted using results of the person trip survey correlating to the zonal parking survey data. Using the existing trip attractions by zone (in PCU) in 2012 and the future trip attractions in PCU by 2035, parking demand is forecasted, while those for 2016 and 2020 are interpolated from the 2035 forecast. The parking facility shortages are then calculated by deducting from these forecasted demands, trips that are expected to be transferred to the public transport and the possible supply of on-street and off-street parking spaces. As a result of this forecast and computation, it is found that a shortage of about 2,500 (refer to (J-K) in 2035 in Table 7.3-2) lots for motorcycle parking and

another about 980 (refer to (J-K) in 2035 in Table 7.3-3) lots for passenger cars are expected in 2035.

(2) Countermeasures

1) Concept

Parking demands for both passenger cars and motorcycles are expected to increase very significantly in the future, especially with the rapid increase in the number of passenger cars in Phnom Penh. With the existing system and parking facilities supply rate, illegal parking problems in the city will deteriorate further, resulting in a very chaotic and unmanageable situation.

As Phnom Penh is a developing city, activities within the city center must be given priority. Hence parking demand in the city center has to be accommodated as much as possible. However, land use in the city center is seriously constrained. For this reason, comprehensive parking countermeasures that include soft measures like a parking restraint policy must be applied.

In addition, in the proposed Urban Transport Master Plan for Phnom Penh, public transport system is expected to become the main backbone of the future urban transport system of the city with a significant overall travel mode share in the future. Hence, mode transfer to public transport from the private modes must also be carefully considered when planning the hard measures for parking such as development of future on-street and off-street parking facilities.

Table 7.3-2 Forecasted Motorcycle Parking Demand after Accounting for On-street Parking Provision

		Current parking demand			Future parking demand						Conversion of public transport							
Item	Current parking demand (A)			Growth rate of attracted car OD from PT survey(B)			Future parking demand (C=A×B)			Public transport conversion rate (D)			Public transport conversion amount (E=C×D)			Parking demand after PT conversion subtraction (F=C-E)		
	Street	Parking	Total	2016	2020	2035	2016	2020	2035	2016	2020	2035	2016	2020	2035	2016	2020	2035
Total	15,560	486	16,046	1.07	1.14	1.39	17,251	18,456	22,974	Setting by zone			863	1,846	6,892	16,388	16,610	16,082
Current Off-street parking spaces				Off-street parking spaces associated with redevelopment						Street space								
Current parking spaces (G)	After Current parking space subtraction (H=F-G)			Off-street parking spaces associated with the redevelopment(I)			After redevelopment subtraction(J=H-I)			Street space(K)			Final excess or deficiency amount after street space subtraction(J-K)					
	2016	2020	2035	2016	2020	2035	2016	2020	2035	2016	2020	2035	2016	2020	2035			
	3,940	12,448	12,670	12,142	337	787	2,473	12,111	11,883	9,669	7,190	7,190	7,190	4,921	4,693	2,479		

Source: PPUTMP Project Team

Table 7.3-3 Forecasted Passenger Car Parking Demand after Accounting for On-street Parking Provision

		Current parking demand			Future parking demand						Conversion of public transport							
Item	Current parking demand (A)			Growth rate of attracted car OD from PT survey(B)			Future parking demand (C=A×B)			Public transport conversion rate (D)			Public transport conversion amount (E=C×D)			Parking demand after PT conversion subtraction (F=C-E)		
	Street	Parking	Total	2016	2020	2035	2016	2020	2035	2016	2020	2035	2016	2020	2035	2016	2020	2035
Total	8,408	109	8,517	1.26	1.51	2.47	10,856	13,196	21,969	Setting by zone			543	1,320	6,591	10,314	11,876	15,378
Current Off-street parking spaces				Off-street parking spaces associated with redevelopment						Street space								
Current parking spaces (G)	After Current parking space subtraction (H=F-G)			Off-street parking spaces associated with the redevelopment(I)			After redevelopment subtraction(J=H-I)			Street space(K)			Final excess or deficiency amount after street space subtraction(J-K)					
	2016	2020	2035	2016	2020	2035	2016	2020	2035	2016	2020	2035	2016	2020	2035			
	2,565	7,749	9,311	12,813	1,175	2,741	8,613	6,574	6,571	4,200	3,219	3,219	3,219	3,355	3,352	981		

Source: PPUTMP Project Team

2) Soft Measures

With effects of mode transfer and the physical measures, future increased parking demand can almost be overcome and a good pedestrian walking environment and a better city landscape can be achieved. This is only possible if we assumed that car and motorcycle drivers are willing to park their vehicles in these parking facilities. For this reason, it is very essential that efficient use of all the parking facilities and enforcement on illegal parking are also implemented.

7.3.4 Development of Comfortable Pedestrian Environment

The city center has a legacy from the French colonial era that influenced the formation of recent street scenes. Wide sidewalks of up to 5.0 m are found on one side along major roads. Even on local roads, sidewalks of 2.0 to 3.0 m are commonly found on one side of these roads. However, most of these wide sidewalks have lost their public spaces status. To ensure a comfortable and conducive walking environment in the city, it is now necessary to reclaim these public sidewalk spaces.

The following are the development policy in order to achieve a good pedestrian environment in the Master Plan.

(1) Development Policy

1) Reclaim the Continuous Public Walking Space for Pedestrians to Move about Comfortably and Safely

In the public experiment, a pedestrian survey was conducted targeting four experimental routes. Results of the pedestrian volume survey indicated that by ensuring the continuity in the sidewalk spaces, pedestrian sidewalks usage has increased from 37.6% to 59.9%. This result has firmly verified the positive effect of having continuous sidewalks in improving the walking environment in the city.

2) Formation of a Pedestrian Network in Promoting Tourism

Presently, many foreign tourists visiting Phnom Penh choose to move about on foot for visiting tourist sites within the city center. However, their movement is often impeded by the lack of a continuous pedestrian network. To promote tourism in the city center, therefore, it is necessary to develop a network of comfortable and continuous sidewalks that link up all the tourist spots so that foreign tourists can move about and visit them safely and comfortably.

(2) Current Problems/Issues

1) Pedestrian Environment Condition

Based on the survey of the study areas involved, there are several specific problems identified which cause the accessibility and mobility of pedestrians to be slow and dangerous such as illegally parked vehicles on sidewalk, no proper pedestrian signage and lack of traffic safety facilities and regulations.

However, these problems are not permanent obstructions that cannot be removed. The present physical condition of the proposed pedestrian network walkways in general is fair with an average width of 5 m, except in the Toul Sleng area where practically all pedestrian walkways are usurped by lot owners. The figure below shows the current condition and problems of the pedestrian network covered.



Source: PPUTMP Project Team

Figure 7.3-10 Current Conditions of the Pedestrian Network

(3) How to Materialize the Development Policies

1) Considering the Functions of Sidewalks

Sidewalks in the city center have various kinds of functions. They serve as spaces for not only walking but also for resting especially those found in the tourist area; for transiting purpose along bus/transit routes; for ensuring safety (basically all sections of the sidewalk); for landscaping purpose such as planting trees; for providing benches; and parking in the case of wide sidewalks usually found in the business/commercial area (see Figure 7.3-11).

Considering the land use, number of pedestrians, potential accident risks and location of tourist spots/urban facilities along the sidewalk, it is important to provide the necessary functions to increase the charm of the sidewalk environment.

2) Considering Networking

To connect tourist spots or urban facilities without interrupting the route is one of the most important factors for the development of a comfortable and charming pedestrian environment.

3) Maximize use of the Project for Development of Traffic Management System

Installation of traffic lights at intersections, pedestrian signals and pedestrian crossing markings also improve the continuation of the pedestrian space.

4) Reflect the Voices of Citizens and Tourists through Public Experiment

Based on the above discussion, Figure 7.3-11 shows a clear image of the Proposed Pedestrian Road Network linking major tourist spots in Phnom Penh.

The proposed pedestrian road network is based on the functions or usage of the walkway. Figure 7.3-11 also explains the walkway functions that are present in each study area involved. These functions are a vital component for the consideration of the study area involved.

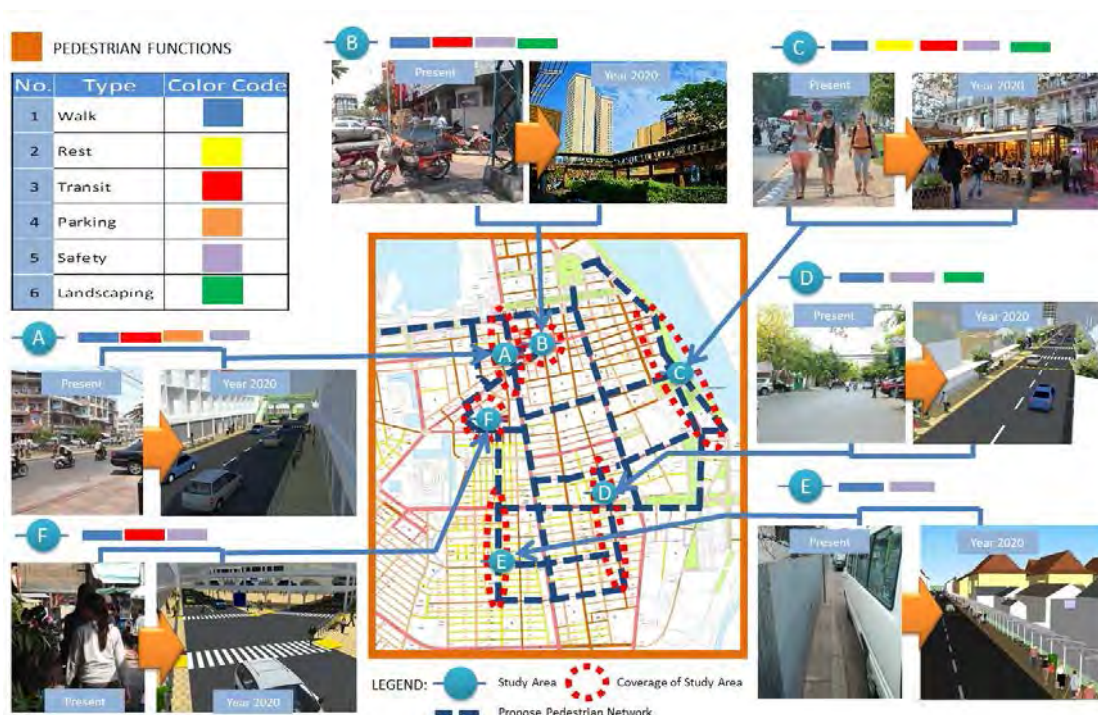

Source: PPUTMP Project Team

Figure 7.3-11 Functions for Sidewalk by Section

(4) Pilot Sidewalk Section for the Medium-term Plan

The proposed pilot sidewalk section for the medium-term plan for Phnom Penh City is Street 240 between Norodom Blvd. and Sisowath Blvd. based on the following reasons:

1. This section is a popular tourist spot/street/area. There are many nice restaurants and souvenir shops. The sidewalk is relatively wide with trees line the street.
2. There is a need to strengthen the east-west pedestrian network to be able to catch up with the north-south network.
3. New traffic signals are installed at three intersections along Street 240, and this improvement secures the pedestrian network continuation and safety.

Proposed actions for better pedestrian circumstances and increase of tourists along Street 240 are as follows:

1. Organize a Street 240 committee, with members from among its citizens and owners of shops along the street;
2. Discuss the merits and demerits of Street 240 to tourists, residents and shop owners;
3. Prepare a street problems/issues map including points described in (2) and develop the countermeasures;
4. Carry out street improvement based on the above countermeasures together with PPCH and DPWT; and
5. Conduct citizens' seminar and disseminate information about activities in the area throughout the city.

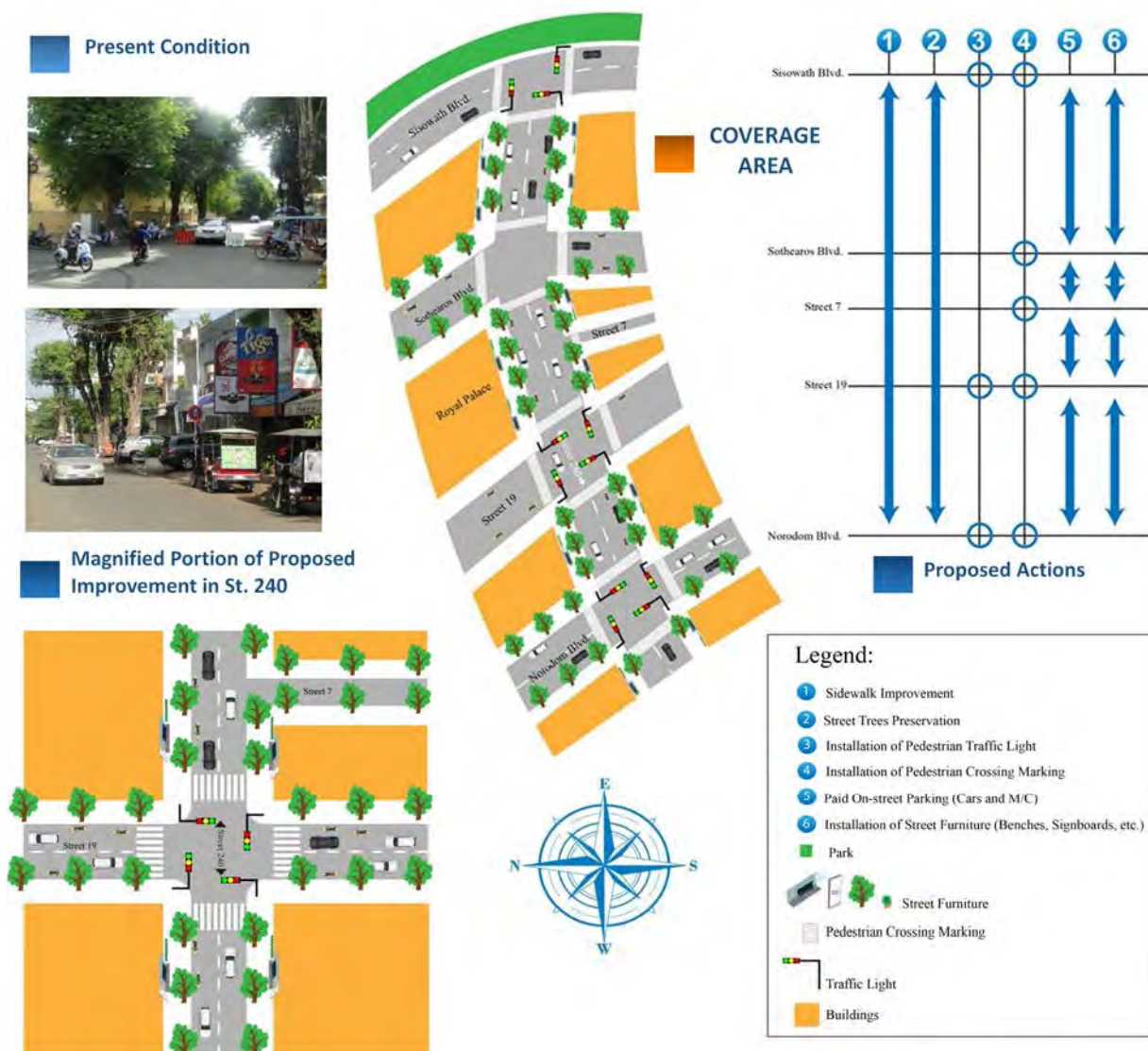

Source: PPUTMP Project Team

Figure 7.3-12 Proposed Pedestrian Circumstance Improvement Plan along Street 240

7.3.5 Drivers' Education and Enforcement

Traffic accidents are often caused by a complex combination of reasons such as poor road environment, inclement weather conditions, abnormal driving behavior or poor vehicle conditions. The topography of Phnom Penh City is relatively flat with no steep slopes or sudden curves. None of the city roads has dangerous alignment which may adversely affect the level of traffic safety. On the other hand, the population of Phnom Penh is expected to increase significantly which will produce many more new drivers in the near future. Once the new and less experienced drivers in the city become the majority drivers, it would indirectly increase the risk of traffic accidents. In many developing countries, new drivers are often given a license to drive without sufficient training on their driving skills and knowledge of traffic safety. Furthermore, traffic accidents in these countries are commonly due to such causes as driving without a license, speeding and drunk driving.

With such background, it is thus necessary to implement a combination of measures that include the installation of traffic safety amenities such as road medians and guardrails, increasing the level of awareness on traffic safety and driver education for a complete understanding of the various traffic regulations and rules; and finally to diligently monitor the implementation of the above measures with proper guidance and support. Enforcement to remove or correct undesirable behavior is equally important whenever actual problematic situations are timely reviewed in order to propose the most suitable countermeasures to overcome them.

(1) Driver Education

Traffic safety is basically aimed at ensuring smooth traffic operation, but in developing countries, it also encompasses the important issue of educating drivers on safety. It is very necessary to implement a comprehensive system of traffic education which includes the mandatory education to the young people before they are eligible to apply for a driver's license.

- Beginning with mandatory education on traffic safety to children (school-going age groups), with repeats if necessary to ensure full completion and full coverage.
- Adult education on traffic safety (license holders) focusing on education during renewal of licenses. Such education shall focus on contents with careful consideration to the score cards records obtained during license application.
- Contents should not be limited to imparting knowledge on traffic safety only, but more importantly, it should also focus on the penalties imposed when an accident occurs and to emphasize the fact that accident not only affect the victim but also the perpetrator.

(2) Traffic Enforcement

Enforcement is but the other necessary half to driver education in ensuring the observance of traffic regulations by road users. Generally, just with the presence of traffic police, observance of traffic rules and regulations can be expected from the drivers. In the city of Phnom Penh, however, the presence of traffic police patrolling the city streets is generally considered not conspicuous. In other words, as long as the issues of lack of effective law enforcement and the relatively light penalties meted out to offenders are not overcome, the beneficial effects from traffic enforcement in improving traffic safety level cannot be expected. Furthermore, in relation to traffic enforcement, it is also very necessary to carry out capacity building in nurturing appropriate manpower specializing in traffic enforcement, providing the necessary equipment and facilities, and finally technology transfer on such training and manpower development. In summary, the following are proposed to ensure the observance of traffic rules and regulations:

- Conduct timely and periodic enforcement exercises
- Strengthen the system of penalties
- Nurturing of traffic police officers
- Furnish the police force with the latest enforcement equipment
- Transfer suitable enforcement technology and know-how

7.3.6 Traffic Demand Management (TDM)

(1) Concept in Traffic Demand Management

TDM refers to programs or strategies that could change or reduce the travel demand so that there is less congestion on the streets. With less congestion, traffic safety improves, less fuel is consumed and vehicular emissions are reduced.

This traffic measures works in such way as to influence travelers to patronize transportation systems like and parking spaces.

(2) Target of TDM

The City Centre will continue to face an ever increasing influx of urban population in the future. The population of PPCC is projected to increase from 1.85 million in 2012 to about 2.87 million by 2035. Notwithstanding this rapid increase, PPCC is expected to provide lively urban spaces in support of its various social and economic activities.

The challenge is how to meet such increases in motorization while working with a very limited urban land area within this city center for more road network development. With the current transportation system in this city center, the increases in travel demand will generate tremendous pressure on the transport facilities thus aggravating further the present urban transport problems. The restraint on use of private motor vehicles and motorcycles thus becomes necessary.

Hence, the ‘target’ of traffic demand management for the city center is to restraint the influx of vehicular traffic into the city center.

(3) Applicable TDM Measures for Phnom Penh

TDM measures should not be implemented individually but rather as a collection or a package of simultaneous measures, in order to achieve the desired overall benefits and maintain the sustainability of such measures. Therefore, TDM measures in this project are proposed as a package with soft and hard measures or plans from each of the related sectors. The following table presents the relationships between the soft TDM measure types and the related hard sector plans or measures.

Phnom Penh needs TDM measures that promote ‘Effective Travel Modes Transfer’; hence, measures involving the introduction of public transport modes are most suitable. The following is basically required for the introduction of a public transport mode:

- Measures in promoting the transfer from passenger cars and motorcycles to public transport modes; and
- Measures in upgrading the convenience and connectivity of public transport systems and the promotion of their usage.



Source: PPUTMP Project Team

Figure 7.3-13 Image Showing Target of TDM

From various actual TDM application examples in other cities, measures that are deemed suitable for implementation in Phnom Penh are given in the table below. These are proposed with careful consideration of Cambodia's national characteristics, its level of understanding on TDM and the unique urban transport features of the city.

Table 7.3-4 Applicable TDM Measures for Phnom Penh

Sector	Applicable TDM measures taken from the Implementing Examples	Outline of proposed measures
Public Transport System	Park & (Bus) Ride	Install parking facilities at bus stops at the outskirts of the City Center for mode transfer. This is to promote and enable the direct transfer from passenger cars and motorcycles to the more efficient public transport modes of travel.
Traffic Management		
Traffic Signal System upgrading	Bus Lane	On the arterials roads in the city center district where road width is sufficient to provide 3 lanes in each direction, one of these lanes can be designated as bus exclusive or priority lane, either for specific time periods or for the entire day. Such a measure is to upgrade the punctuality and reliability of the bus transport system.
	Bus priority signal control system	By giving signal priority for buses to pass through the signalized intersections along the major arterials in the city center area, it is possible to maintain the travel speeds of buses and hence improve the punctuality of the bus service. This is to promote the usage of bus transport.
	Road traffic information dissemination system	Provide information such as road congestion or bus operation situations at bus stops or over the internet to the public. This measure can improve the convenience of traveler to the city center as well as promote the use of bus transport.
Parking measures	On-street parking control	Strict enforcement of on-street parking along the bus routes on the major arterials roads in the city center by the use of road surface markings and warning signs. This measure can also indirectly support the improvement on the reliability and punctuality of the public transport and hence encourage its usage.
Improvement of pedestrian walking environment	Installation of Transit Mall	Allow the co-existence of public transport and pedestrian walking space within the central commercial district in the city center. As a supplementary measure, upgrade the bus stops and ensure the continuity of pedestrian network. Such measures would improve the convenience of public transport and hence encourage its usage.
Driver's education	Mobility management	TDM requires the pre-requisite that road users have a high level of understanding on the traffic rules and regulations, good etiquette and self-restraint, good thinking before taking mobility actions. Therefore, the upgrading of traffic education in Phnom Penh is very necessary.
Commodity Transport Improvement	Installation of Commodity Loading and Parking Bays	Strict enforcement on curbside commodity loading / parking along bus routes on the major arterials in the city center by the use of effective road surface markings or warning signs. This is to support the punctuality and reliability of public transport and hence encourage its usage.

Source: PPUTMP Project Team

7.4 Commodity Flow

7.4.1 Planning Strategy

Future plan for cargo transport in the Project area is considered by three levels: i) inter-regional freight transport system, ii) urban logistics system and iii) cargo handling facility at final destination in the city.

(1) Inter-Regional Freight Transport System

Inter-regional freight transport system consists of large-scale cargo facilities such as port, airport, cargo terminal of railway station, SEZ and industrial area, and transport network connecting those facilities. Inter-regional freight transport is long distance trip, and theoretically, facilities for inter-regional freight transport should be located outside the urban area for environmental reasons. Inter-regional freight transport route considered as the industrial road should be separated from community road as much as possible and should be constructed or improved according to design standards for heavy truck traffic. To maintain a comfortable living environment in the urban area, there should be restrictions in the area and hours of through-traffic of heavy trucks in accordance with the development and expansion of the urbanized area.

(2) Urban Logistics System

An urban logistics system such as logistics center or distribution centers is established for i) the reduction of lead time, i.e., time from order of goods to delivery of goods by placing deposit of goods near destination of delivery, and ii) reduction of freight transport cost by improvement of efficiency of truck transport such as consolidation of goods. Small-scale warehouses and wholesale businesses in the city center should be integrated into urban logistics centers on the edge of urban areas in order to reduce truck trip generation in the city center and reduce inharmonious facility with existing and future land use. Urban logistics centers generate considerable truck traffic; therefore, it should be located along highways or arterial roads with sufficient road width and number of lanes. Furthermore, an urban logistics center should be located keeping relevant law and regulation such as land use control. The urban logistics center is expected to provide service of secured cargo deposit and shipment of required volume of cargo at required time. Therefore, the urban logistics center should consist of proper area for deposit of cargo, assorting of cargo, truck berth and loading space etc.

(3) Cargo Handling Facility and Management in the Street

Cargo is eventually picked up or delivered by truck at residence/shop/office along the street in the urbanized area. Therefore, on-street/off-street parking lot for loading/unloading goods close to final destination is required to avoid traffic congestion caused by trucks. If preparing a parking lot for loading/unloading is difficult, other measures such as time-sharing with other vehicles should be considered.

7.4.2 Sector Plan of Freight Transport

(1) Inter-Regional and Urban Logistics Plan

- Inter-regional freight transport facilities in the Project area consists of existing and new Phnom Penh Port, international airport, planned railway freight terminal, Phnom Penh SEZ and other existing and planned industrial areas. With the proposed industrial center and sub-centers, and from the urban structure viewpoint, a function of logistics facility is expected to be included to handle, for example, transshipment of large volumes of cargo from/to external of Phnom Penh and small volumes of cargo

from/to Phnom Penh City.

- According to Phnom Penh Autonomous Port (PPAP), the existing Phnom Penh Port will still function as a cargo port. From the viewpoint of urban transport and environment, however, a cargo port which generates considerable heavy truck traffic in the city center is unsuitable. Therefore, it is proposed to redevelop the existing Phnom Penh Port mainly as a passenger port with plenty of tourist attractions and to transfer almost all function of the existing Phnom Penh Port as a cargo port to the new port.
- National Road No. 1, No. 6 and Ring Road III will serve as inter-regional freight transport route which connect major logistics facilities, and these roads are expected to be improved as an appropriate truck transport route, for example, as roads with two lanes per direction or roads with adequate shoulder.
- Law and regulation on land use control along truck transport routes should be enforced to avoid the mixing of truck traffic with other daily traffic.
- Truck restriction area is expected to be expanded in the future in accordance with the expansion of the urbanized area in the future. For example, the restriction area is expanded to within Ring Road III during 5:00 – 21:00 on weekdays same as existing condition.
- Establishment or strengthening of existing organization for road maintenance is expected to maintain good road condition for truck transport routes.

(2) Urban Logistics System

An urban logistics system such as an urban distribution center is expected to be located along arterial roads on the outer edge of urbanized areas to accept and store large volumes of cargo carried by heavy trucks, and send out small volumes of cargo by light trucks. The urban logistics center for the Project area, therefore, is expected to be set up with such types of facility as that facility located inside of existing/future industrial centers/sub-centers or a redeveloped existing market in the city.

(3) Cargo Handling Facility and Management in the Street

A guide for preparing an appropriate parking lot/space for loading/unloading in the city center is provided below.

- On the street which has enough shoulder to park a vehicle, parking lot/space for loading/unloading truck should be reserved by marking the road surface or by putting a road cone.
- On the street which has insufficient shoulder to park a vehicle, parking lot/space on the sidewalk or parking bay by cutting a part of sidewalk should be reserved with sufficient consideration taken for pedestrians.
- On the street with insufficient shoulder and sidewalk, soft measures should be considered such as i) enforcement of on-street parking regulation in off-peak excluding loading/unloading trucks, ii) parking time sharing with trucks and other vehicles, iii) cooperated parking space for loading/unloading by utilization of existing off-street parking or petrol station.
- Concerning off-street parking, i) institutionalization of mandatory attached parking facilities for

large-scale facilities and development, and ii) prohibition of use of existing off-street parking for other purposes such as street vendors are expected.

In the case of Japan, the required parking lot width of parking lot is more than 3 meters. In the Phnom Penh city center, based on the road inventory survey, several streets such as Monireth and Monivong Blvd. have shoulders widths of 3 m or more, and many streets have sidewalks with widths of 3 m or more. Based on the parking interview survey, 75% of truck drivers park within 50 m to final destination and 83% of truck drivers park within 100 m.

- In the center of Daun Penh, it is possible to reserve parking space on the sidewalk for loading/unloading trucks when other on-street parking vehicles and goods removed from the street because of its high-density has a stretch of sidewalk with a width of 3 m or more. However, the sidewalk space reserved for pedestrians must be more than 2 m.
- In other areas such as Makara, Toul Kork and Chamkar Mom, there are only few sidewalks with width of more than 3 m; therefore, soft measures such as reservation of parking space on the sidewalk and hard measures such as improvement of shoulder, sidewalk and off-street parking should be considered.

7.5 Environmental and Social Considerations

7.5.1 Sector Plan

From environmental and social viewpoints, existing issues need to be addressed in order to implement the goal of this master plan. In a series of stakeholder meetings, the expected future urban environment in the Project area was discussed, and the following three visions were crafted:

- Rich and comfortable urban environment with parks and street trees along sidewalks is provided in the city center.
- In the suburban area, agricultural land is appropriately managed and cultivated even though its total area has decreased a little. This supports a part of the city's economic production and maintains the urban environment.
- A variety of ecosystems is brought up based on the agricultural land, remaining ponds/lakes and natural greenery.

In order to achieve the three visions, the following practical measures are proposed:

General:

- To prevent deterioration of air quality and noise
- To mitigate CO2 emissions

City centre:

- To secure urban parks and greens
- To improve the environment of public transport facilities including sidewalks

Suburban area and outskirts of the city:

- To preserve agricultural land by well-planned suburban developments
- To protect green area including lakes and wetland for keeping the diversity of the ecosystem

(1) To Prevent Deterioration of Air Quality and Noise

Taking into account the number of vehicles in the future, it is expected that air quality and noise will deteriorate further particularly in high-density and congested areas as vehicles continue to increase. In addition to introduction of public transport, TDM and vehicle inspection system, the following measures are also important in relation to the environment.

Monitoring of air quality and its data can contribute to understand the existing condition compared to the standard and serve as reliable information for traffic control. In addition to the monitoring by the Ministry

of Environment (MOE) at three locations in Phnom Penh, more number of monitoring points is necessary in order to comprehend air quality appropriately. It is therefore proposed to set air pollution monitoring stations in areas likely to be affected by air pollution and accumulate data. To do so, the installation of such necessary equipment and the establishment of a new organization responsible for the monitoring under the Department of Environment, Phnom Penh Capital City (DEPP) need to be considered.

(2) To Mitigate CO2 Emissions

In order to mitigate CO2 emissions from vehicle operation, the measures can be categorized into three: 1) reduction of vehicle emission, 2) decreasing traffic volume, and 3) measures for CO2 absorption. The categories are illustrated with details in the following figure.

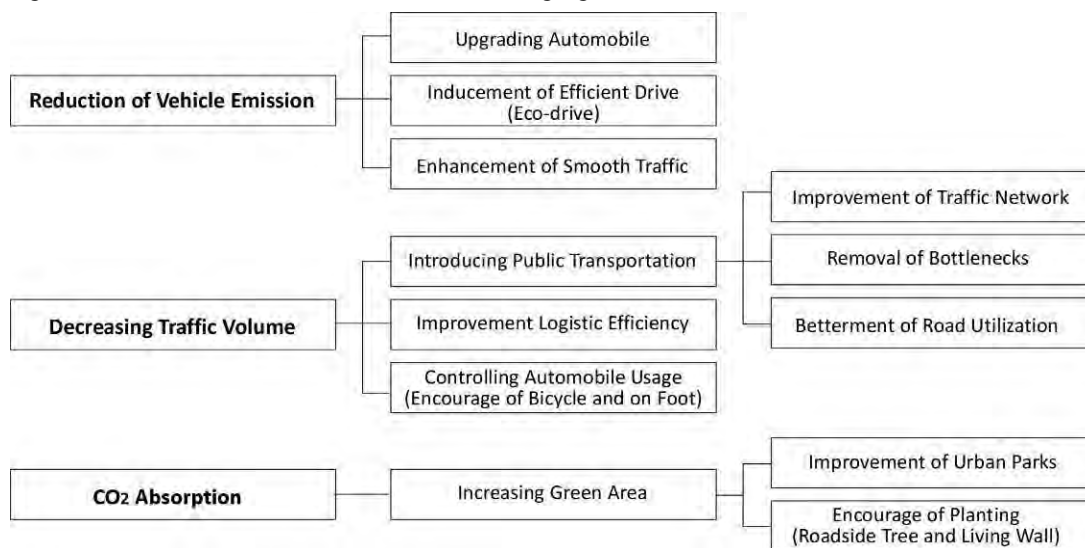

Source: PPUTMP Project Team

Figure 7.5-1 Major Mitigation Measures of CO2 Emission

(3) To Secure Urban Parks and Greens

In the central area of Phnom Penh, the urban parks and green area tend to decrease in accordance with the progress of urban development. Urban parks not only provide recreation space, they can also be used as evacuation places in case of disasters. They also help to mitigate heat island effect, to absorb CO2, to promote biodiversity and to reduce storm-water runoff. Therefore, urban parks need to be distributed appropriately depending upon the population and density.

In terms of size of urban parks, 20 sqm/person is recently respected as the standard in the major cities. Existing conditions in the central area of Phnom Penh would benefit from more parks and green spaces development. However, there is limited vacant space based on existing land use, although such open spaces seem to have a potential to be urban parks. Further urban development and redevelopment are strongly recommended to include formulation of parks and green area.

(4) To Improve Environment of Public Transport Facilities Including Sidewalks

In order to enhance utilization of public transportation, user-friendly access to the facilities including stations and sidewalks needs to be improved especially for vulnerable groups such as children, the elderly and expectant mothers. Many sidewalks in Phnom Penh are large in width. However, they are used for parking of cars and motorcycles. Moreover, some sidewalks which are bumpy and rather high are not user-friendly at all. Accordingly, control of inappropriate parking and redesign of sidewalk are vital. Another issue is related to garbage. Litters have been observed in some areas due to lack of service for

garbage collection. A reduced service is likely to be caused by insufficient fee collection in the area of low-income households. There is a need for a review of welfare services in Phnom Penh for such areas to receive subsidized services. Additionally, planting roadside trees is recommended in order to provide better landscape and shade from sunlight for pedestrians.

(5) To Preserve Agricultural Land by Well-planned Suburban Developments

With a view to preserve existing agricultural land and green area, well-planned development plans and appropriate control are important. Urban sprawl has started in the suburban area and outskirts of the city in accordance with urbanization. Further urban development is expected brought about by pressure from urban population growth in the future. Since the land use plan does not cover the entire municipal boundaries including new municipality area, a review of the plan needs to be done immediately. The land use is recommended to provide contrasts of development and preserved area in order to prevent urban sprawl. This idea induces the formulation of population agglomerations in the suburban area. Moreover, it facilitates the improvement of urban infrastructure and the provision of services such as water supply, sewage and waste solid management.

(6) To Protect Green Area Including Lakes and Wetland for Keeping Diversity of the Ecosystem

In the outskirts of Phnom Penh Capital City (PPCC), along the IRR, there are still many green area including cultivation area, lakes and wetland. In order to protect the ecosystem and biodiversity in these areas, an appropriate development plan and control system are vital as well as suburban areas. On the other hand, open dumping sites and wastewater treatments by means of lagoon system. Considering the increase of urban population in the future, there is concern that the capacity of such dumping sites and wastewater treatment system is inadequate to meet the demand. With regard to solid waste management, advocating the “3Rs”; namely, reduce, reuse and recycling and efforts to decrease garbage by DEPP need to continue into the future. It is recommended that the plan of final disposal site be reviewed from time to time taking into account its impacts on the environment.

7.5.2 Strategic Environmental Assessment (SEA)

SEA is one of the most appropriate tools for decision-making on plans, programs and projects since it enables to ensure that potential environment impacts are identified and communicated to the decision-makings in the early stage. Additionally, in the decision-making process, information on the plan, programme and project is shared and discussed among the stakeholders in order to reflect their opinions into the decision-making. Based upon such information disclosure process, it enables to achieve consensus from the stakeholders. Thus SEA is considered as one of efficient systems for sustainable development.

(1) SEA of PPUTMP

Taking into account the type of project of PPUTMP and the area it covers, the Project team conducted series of SEA-related activities corresponding with the work flow of the project as listed below.

- a) Identified Problems and Issues of Urban, Transport and Environmental Aspects
- b) Basic Direction of Comprehensive Urban Transport Master Plan
- c) Stakeholder Meetings
- d) Formulation of Implementation Plan and Short- and Medium-Term Action Plans
- e) Pre-Feasibility Study (F/S)
- f) Seminar
- g) Rolling Plan by Stakeholders (after the project)

(2) Stakeholders

Involvement of not only counterparts and implementation bodies but also stakeholders is one of the unique

processes in SEA. To sit at the same table with a wide range of organizations could contribute to make nonbiased discussions and to share information about future plans. The stakeholders of this project were determined by the stakeholder analyses, and they were selected from various organizations such as commercial organizations, Sangkat representatives, transport-related organizations and others.

7.6 Master Plan Long-List

7.6.1 Public Transport

The outline and location of the public transport projects are shown in Table 7.6-1 and Figure 7.6-1, respectively.

Table 7.6-1 Outline of the Public Transport Projects in the Long-list

Code	Project Name	Project Outline	Quantity	Remarks
PT - 1	Rail Transit (Phase 1)	Rail Transit (Elevated and partially underground) Chaom Chau - Central Market (CM) (via Russia or Monireth/Veng Sreng)	Total length=14.0km	Long-term
PT - 2	Rail Transit (Phase 2)	Rail Transit (Elevated and partially underground) Chaom Chau - CM (via Russia or Monireth), GPIC to CM and Takmau to CM	Total length=30.8 km	Long-term
PT - 3	Rail Transit Station	Intermediate rail transit station	No. of stations=43	Long-term
PT - 4	Rail Transit Airport Station	Rail transit station directly connects the airport	No. of stations=1	Long-term
PT - 5	Rail Transit Depot	Stored and maintained of rail transit	No. of depots=2	Long-term
PT - 6	Bus Route	Covered entire PPCC	Total length=426 km	Short to Long-term (Medium-term: 148 km)
PT - 7	Bus depot	Stored and maintained of buses	No. of depot=2	Short-Medium-term to
PT - 8	Multi-modal Interchange Complex	Terminal complex (Rail transit + City bus + Intercity bus)	No. of terminals=4	Long-term
PT - 9	Bus Terminal (Type 1)	City bus + Intercity bus	No. of terminals=3	Short-Long-term to
PT - 10	Bus Terminal (Type 2)	City bus terminal	No. of terminals=7	Short-Long-term to
PT - 11	Bus stop	Bus stop interval, cc: 300m and suburban: 500 m	No. of bus stops (Phase 1) =389 No. of bus stops =924 (cc: 180 and 744)	Short to Long-term Phase 1 (Total: 389, cc: 234 and 155)
PT - 12	BRT	Bus Rapid Transit System (Bus route with more than 6 lanes road)		Medium-Long-term to
PT - 13	Bus priority measures	Bus priority/exclusive lane (Bus route with more than 4 lanes road)		Short-Long-term to
PT - 14	Bus location system	Bus operation information is provided via mobile phones and displays at bus stops including e-mail when a bus is approaching.		Medium-Long-term to
PT - 15	Restructuring of the para-transit operation (1)	Zone system for Motodop		Short-Medium-term to
PT - 16	Restructuring of the para-transit operation (2)	Exclusive route system for Motorumok-modern (tuk-tuk)		Short-Medium-term to

PT - 17	Restructuring of the para-transit operation (3)	Zone system for Cyclo		Short-Medium-term to
PT - 18	Restructuring of the para-transit operation (4)	Improvement of commuter trucks in the suburban area		Short-term
PT - 19	Introduction of commuter rail system	Using existing rail system between Central station and PPSEZ station	Total length=19.3 km	Medium-term
PT - 20	Commuter Rail Station	Intermediate stations	No. of stations=9	Medium-term
PT - 21	Improvement of water transport	Improvement of transfer facilities between water transport and bus	No. of jetties=11	Medium-term

Source: PPUTMP Project Team

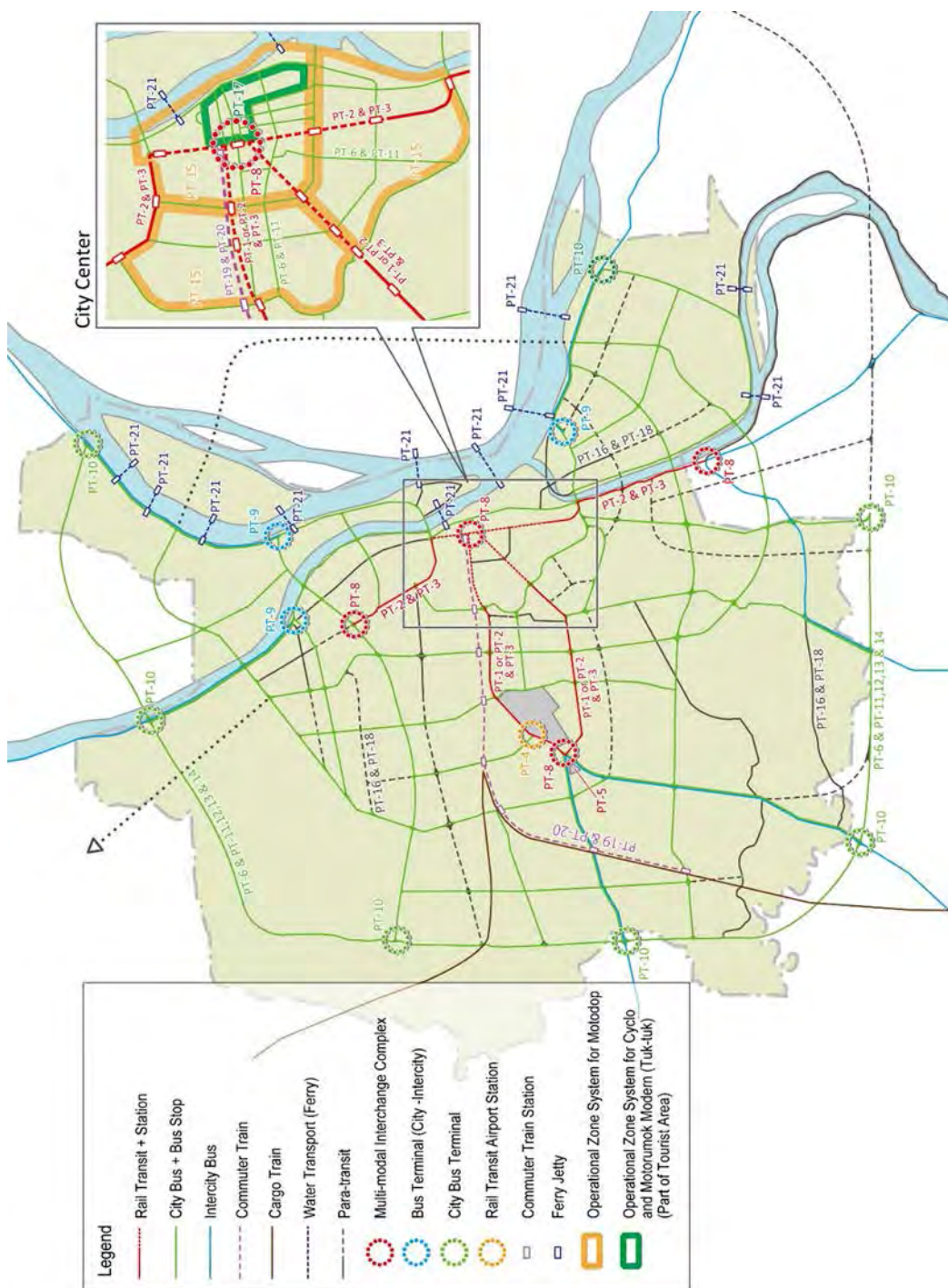

Source: PPUTMP Project Team

Figure 7.6-1 Location of Public Transport Projects in the Long-list

7.6.2 Road

The road projects proposed in the Master Plan are identified and coded and listed as shown in Table 7.6-2 below.

Table 7.6-2 List of Road Project Packages

Code	Project Name	Project Components	Total Length (km)
RP-1	Widening and Sidewalk of Arterials in Central Area(IRR, Monireth, Toul Kok)	A1,A2,A3,A4,A5	10.1
RP-2	Boeng Kok Road	A6, C52	6.5
RP-3	Missing Links in Central Area	C50, C51	1.3
RP-4	Widening of NR1, Chabar Ampov - New PP Port	A25,A26	25.3
RP-5	New E-W Arterial Road (NR1 - Cheng Aek Road)	A7,A8	11.5
RP-6	New E-W Arterial Road (Cheng Aek - RR-IV)	A9, A33	16.1
RR-7	New and Widening of RR-II (NR2 - NR5)	A12,A13,A14	20.4
RR-8	Extension of RR-II (NR5-NR6)	A15	2.9
RP-9	RR-III (NR1 - Junction with NR21)	A16	18.5
RP-10	RR-III(NR21 - NR4)	A17,A18	24.5
RR-11	Widening of RR-III(NR4 - 4km section)	A19	4.1
RR-12	Widening of RR-III(4km from NR4 - Preak Pnob Bridge)	A20	10.7
RP-13	RR-IV (NR1 - NR6)	A21,A22,A23,A24	80.8
RP-14	Widening of NR2 (Junction with NR21 - RR-III)	A27, A31	12.1
RP-15	Widening of NR3 (Junction with RR-III - RR-IV)	A32	9.2
RP-16	Widening of Chaom Chao Road	A30	8.4
RP-17	Widening of Russia/NR4 (IRR - RR-IV)	A34, A35	15.2
RP-18	New E-W Arterial in Sen Sok(Toul Kok - RR-IV)	A36, A37	15.9
RP-19	Widening of Hanoi Road (RR-II - RR-III)	A38	4.9
RP-20	Widening of NR5 (Chruoy Changvar Bridge - RR-IV)	A39, A40	15.0
RP-21	Chban Ampov area Development Road package	C2, C6, C7, C9	18.9
RP-22	Mean Chey District Urban Development road package	C3, C4, C5	27.0
RP-23	Mean Chey - Diamond Island Connection Rd package	C1, C8	5.8
RP-24	AZ Green City Development Road package	A28,C10, C11, C12	34.2
RP-25	Chaom Chao South Area Development road package	A29,C15, C16, C17, C18	25.7
RP-26	Russia - Chaom Chao Connection & Boeng Tumpun Access	C13, C14, C19	8.5
RP-27	Samraon Kraom Sub-center Development Road package	C20, C21, C39	15.3
RP-28	Western Peripheral area development roads bw RR-III and RR-IV	C45, C47, C49, C46	31.2
RP-29	Phnom Penh Thmei district Development package(West of Hanoi)	C40, C37, C41	22.5
RP-30	Krang Thnong New Sub-center package	C42, C43, C44, C38	20.8
RP-31	Camko/Grand Phnom Penh Development package	C22, C35, C36	9.8
RP-32	Ruessei Keo, Kilolekh6 area Development roads	C23, C24	9.3
RP-33	Soka, Chruoy Changvar Development roads	C26, C27, C25	9.6
RP-34	Garden City Preak Pnob Development roads	C28, C29, C30, C31, C32, C33	37.5
RP-35	Flyover or Underpass Project in the Central Area(Monivong North, Toul Kok, Monivong South)		1.1
RP-36	Flyover or Underpass Project (Monivong North, Toul Kok, Monivong South, Hanoi/Russia, Hanoi/Chaom Chao, Cheng Aek/Tumpob Thmei, ICs or Flyovers along RR-III and RR-IV)		9.3

Source: PPUTMP Project Team

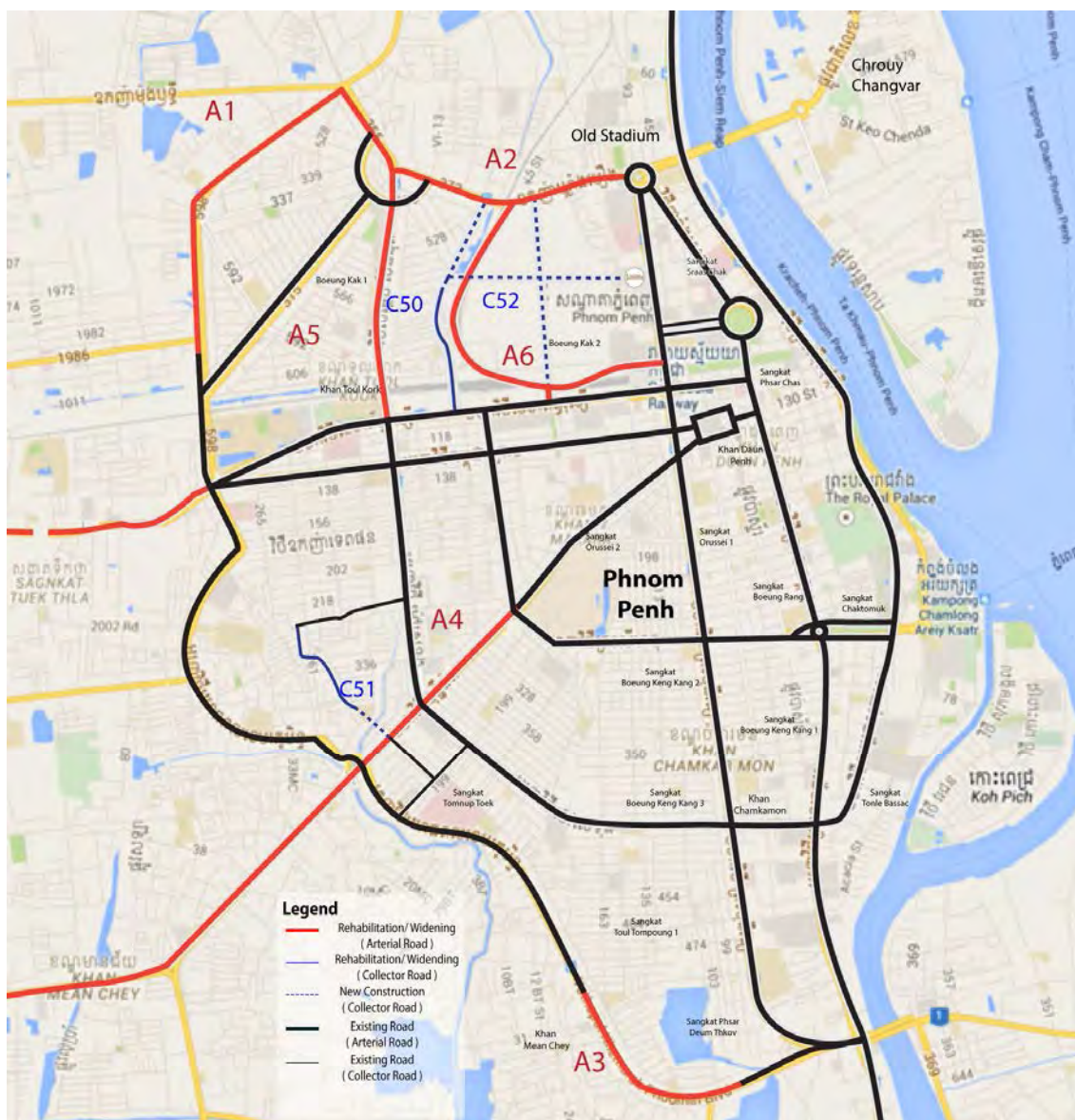

Source: PPUTMP Project Team

Figure 7.6-2 Proposed Road Projects in the Central Area

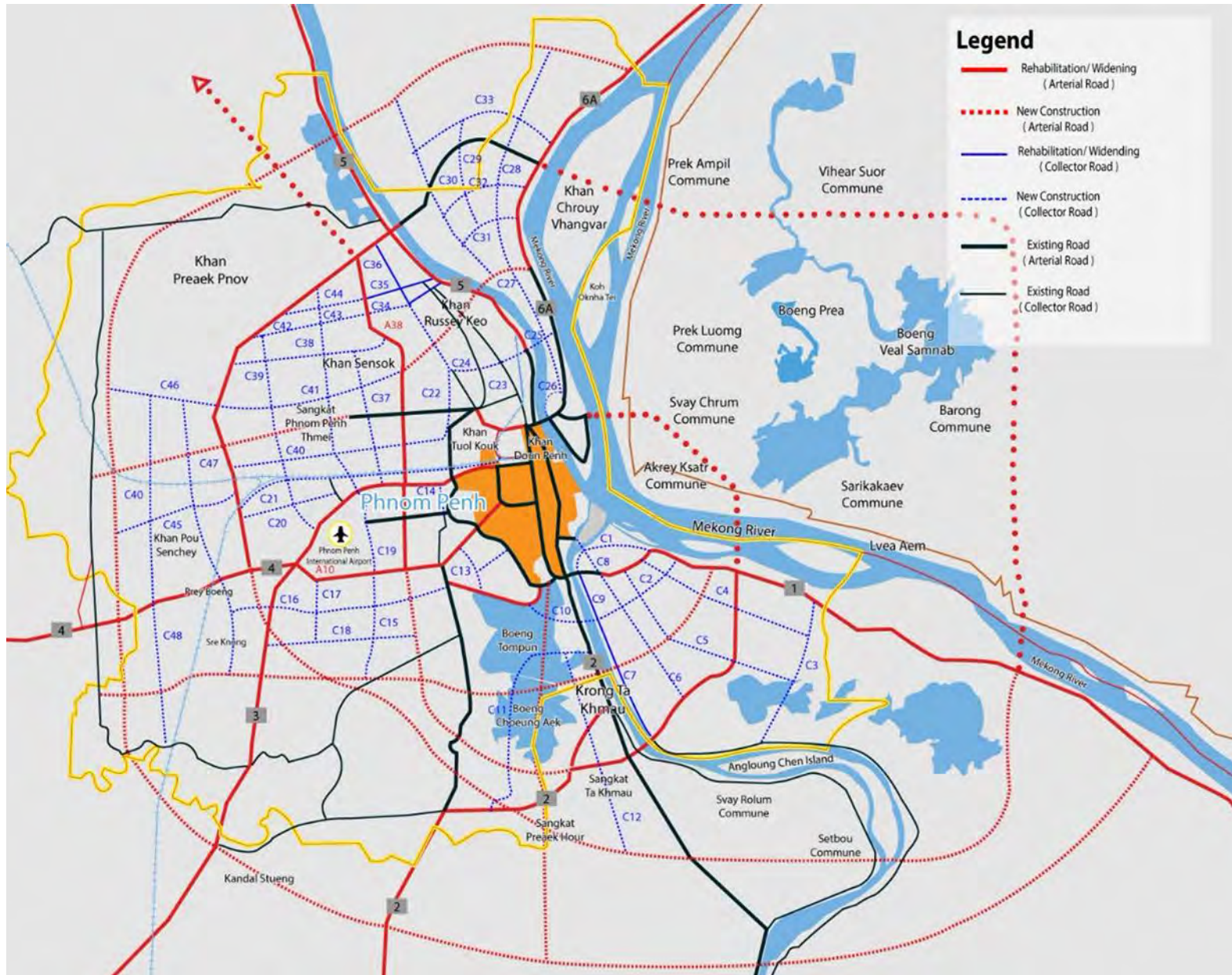

Source: PPUTMP Project Team

Figure 7.6-3 Proposed Road Projects in the Suburban Area

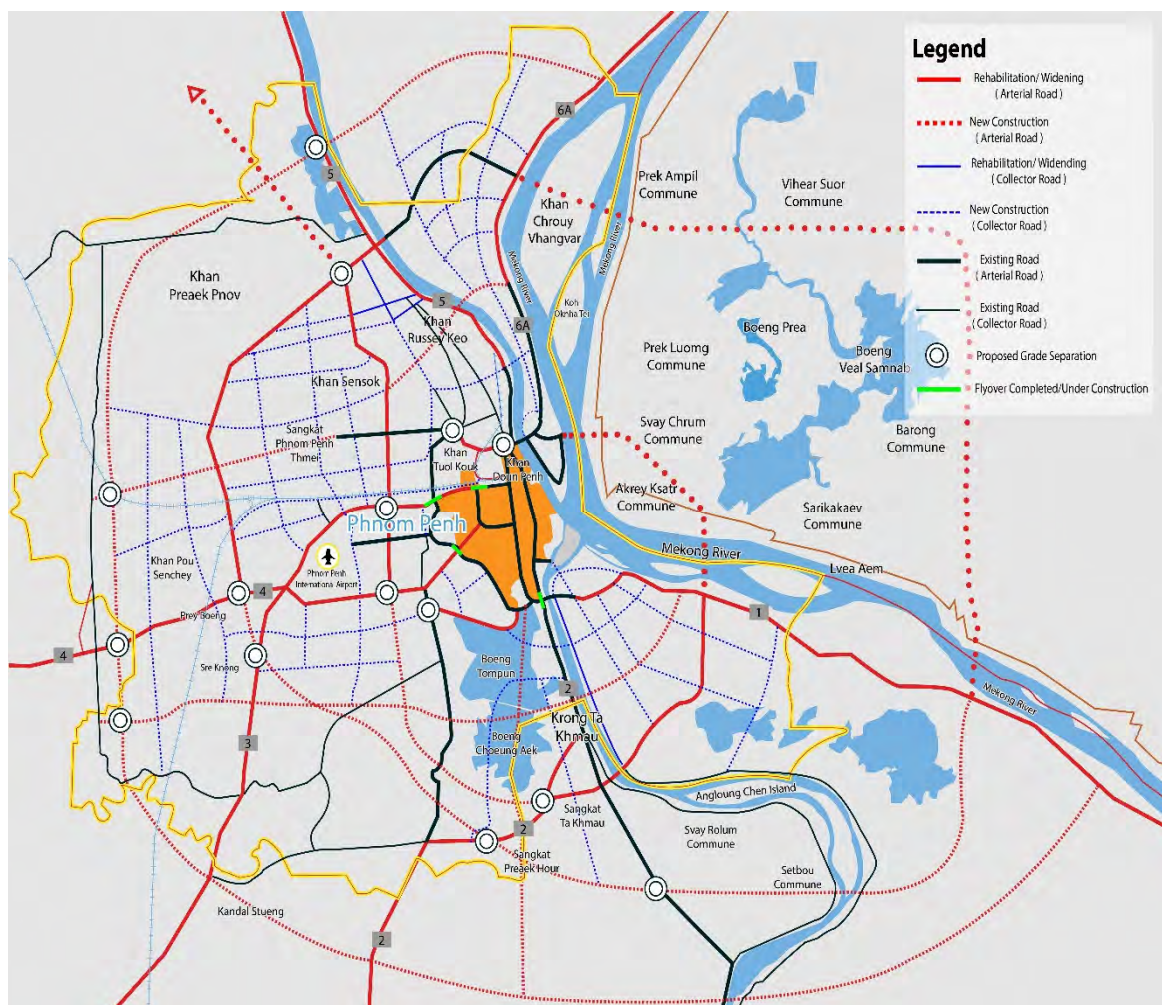

Source: PPUTMP Project Team

Figure 7.6-4 Location Map of Proposed Grade Separated Intersections

7.6.3 Traffic Management

The outline and location of the traffic management projects are shown in Table 12-3 and Figure 12-4, respectively.

Table 7.6-3 Traffic Management Projects in the Long-list

Code	Project Name	Project Outline		Quantity	Remarks	
TM-1	Chamkar Morn Intersection	Smooth traffic flow in the intersection	Signal phasing adjustment	One intersection	Short-term	
TM-2	Neang Kong Hing Intersection	Smooth traffic flow in the intersection	Revision of traffic regulation	One intersection	Short-term	
			Signal phasing adjustment	One intersection		
TM-3	Chrouy Changvar Intersection	Smooth traffic flow along IRR	Underpass	Tunnel: 70 m Approach: 200 m	Short-term	
TM-4	One-way system	Introduction of one-way system		Length: 10.9 km	Short- to Medium-term	
TM-5	Parking measures	Provision of parking space	Off-road parking	M/C: 2,500 Car: 8,600	Short- to Long-term	
			On-road parking	M/C: 7,200 Car: 3,200		
			Parking information system			
TM-6	Development of comfortable pedestrian environment	Vitalization of tourism and city's activities through the development of comfortable pedestrian environment	Dissemination to citizens along the roads		Short- to Medium-term	
			Guide to clear the sidewalks of illegal parking, etc.			
			Development of the sidewalk widening			
TM-7	Transit mall	Development of pedestrian and public transport oriented urban space to vitalize the city center and to minimize traffic congestions		Length: 1 km	Medium-term	
City Center	TM-8	City center traffic signal improvement project for 100 intersections	Effective road space use in the city center	Synchronized traffic signal control	3 intersections along Monivong	Short- to Medium-term
				Area traffic control system	Initial system covers 100 signals	
				Intelligent traffic signal		
				Traffic surveillance system	Initial system covers 26 intersections (cameras). The system will be installed at TCC together with area traffic control center.	
				Traffic monitoring system using probe vehicles		
				Traffic information system (Variable message sign system)	Initial system covers 8 VMSs (locations).	
				Transit signal priority system		
	TM-9	Park and bus ride	Improvement of traffic and environmental conditions in the city center	Transfer to bus from cars in the suburban area	Suburban bus terminals	Medium- to Long-term
TM-10	Mobility management	The mobility management (MM) comprises "soft" measures, which enhance the effectiveness of "hard" measures of traffic planning. The MM tools do not necessarily require large investments measured against their high potential to change mobility behavior. The objective of MM is to reduce single-car use.			Medium- to Long-term	
TM-11	Driver's education and traffic enforcement	Dissemination of traffic regulation and rules to the citizens for safe, smooth and comfortable urban transport system			Short-, Medium- to Long-term	
TM-12	Preparation of parking space for loading/unloading trucks in the city center	Use of part of car parking space along the trunk roads for truck loading/unloading for trucks during the off-peak period			Short-, Medium- to Long-term	

Source: PPUTMP Project Team

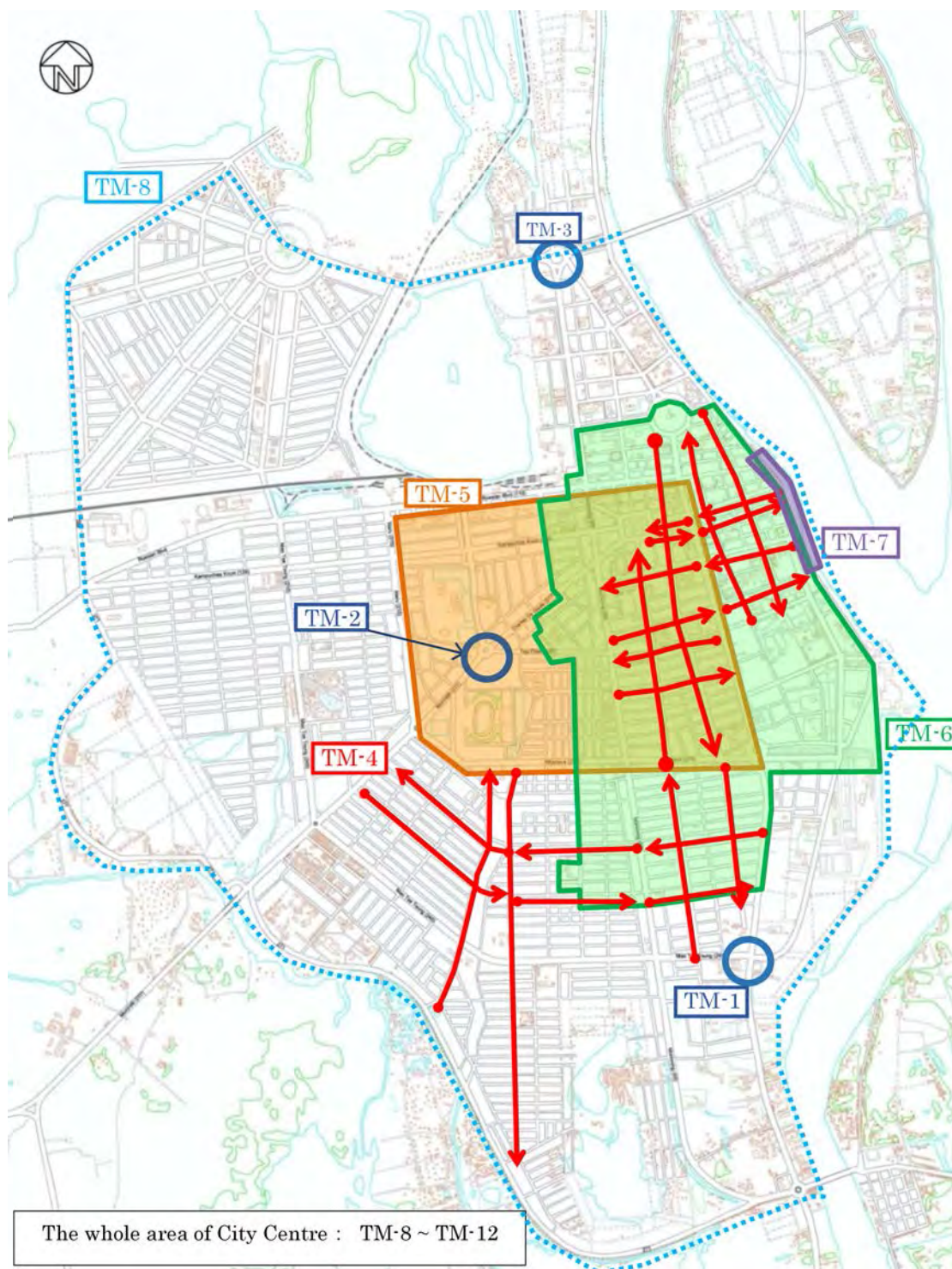

Source: PPUTMP Project Team

Figure 7.6-5 Location of Traffic Management Projects

8. ORGANIZATION AND FINANCIAL CONSIDERATIONS

8.1 Proposed Organizations

8.1.1 Reorganization of DPWT

The Department of Public Works and Transport (DPWT) underwent reorganization last September 2013. The Public Transport Management Division (PTMD) is in charge of the part of existing Transport Office. PPCH announced the setup of new organization an opportunity afforded by starting the city bus operation. After the public experiment on city bus operation, PPCH and DPWT again reorganized the PTMD into the Public Transport Management Authority (PTMA). This new organization is dedicated to overseeing the city bus operation. PTMA is an independent body which is directly under the PPCH Governor and operates with collaboration between PPCH (administration/management) and DPWT (operation/maintenance).

8.1.2 Establishment of Phnom Penh Urban Transport Authority (PPUTA)

(1) Transition to PPUTA

It is essential that an independent organization for public transport be established to enhance the smooth flow of traffic with sustainable and constructive growth in MPP. The PPUTMP project team has proposed to set up the Phnom Penh Urban Transport Authority (PPUTA) as response to the issue relative to the urban transport system under national level organization, especially the management/operation of the newly proposed rail transit.

The responsibility of the new organization to be established is development planning and transport implementation of transport related activities the area of PPCC, much like a role and responsibility of the existing PTMD. PPUTA shall duly conjecture the scale of urban transport issues utilizing management indicators based on the discussion on expected characteristics of public transport.

Prior the creation of the PPUTA, the PPUTMP project team suggested setting up a transitional advisory committee to coordinate the urban transport projects. This committee shall prefigure the future framework for the transport sector in PPCC and more clearly define the role and responsibility of PPUTA.

(2) Proposed (PPUTA) Structure

The proposed structure for PPUTA prepared by the PPUTMP project is shown in Table 8.1-1. However, it is important to discuss with stakeholders the role and responsibility of PPUTA

Table 8.1-1 Outline of PPUTA (Tentative)

Item	Content
Status	Autonomous state corporation
Objective	<ol style="list-style-type: none"> 1. Towards comfortable city street environment <ul style="list-style-type: none"> ➤ Preparation of public transport policy ➤ Establishment of practical guideline for public transport ➤ Management of traffic mode 2. Solution of traffic congestion <ul style="list-style-type: none"> ➤ Tackling of parking issues ➤ Control of Tuk Tuk routes ➤ Management of application for new public transport system 3. Maintenance of city assets <ul style="list-style-type: none"> ➤ Clearance of walkway ➤ Inventory of parking lot ➤ Evaluation of private operator
Role and Responsibility	<ol style="list-style-type: none"> 1. Monitoring the Comprehensive Urban Transport Plan (JICA MP) 2. Coordinate the different stakeholders (interministerial) 3. Coordinate transport projects 4. Design the mobility policy framework 5. Better apprehend urban growth, mobility and transport means 6. Design the transport planning documents 7. Draw up the transport contracts for pay lot parking, traffic signal, traffic control system, bus stations, ferry station and logistic infrastructure 8. Draw up the tariff policy and the subsidies level for pay lot parking price, transport ticket price and reduction policy
Need of Technical Capacity	<ol style="list-style-type: none"> 1. Transport Planning 2. Parking Management 3. Traffic Management 4. Public Transport Design and Management
Process to Creation	<ol style="list-style-type: none"> 1. Sub-Decree creating for PPUTA and appointment of member of Board 2. Budgets allocation 3. Capacity of human resource 4. Technical assistance from Donors
Organization	<ol style="list-style-type: none"> 1. Administrative division: Policy, guideline, personnel, financial, planning and public relation 2. Facility division: Maintenance of fleet or track, signal, structure, station and rail 3. Transportation division: Bus or train service, station control, safety management
Consideration of Operation Process	<ol style="list-style-type: none"> 1. Clarification of operation policy <ul style="list-style-type: none"> ➤ Shared awareness of operation policy among Authority members 2. Clarification of role and responsibility <ul style="list-style-type: none"> ➤ Achievement of task for each division/staff 3. Draw up business plan <ul style="list-style-type: none"> ➤ Analysis of current traffic issues ➤ Identification the needs of public opinion ➤ Setup the goal of PPUTA ➤ Planning the concrete projects such as public transport routes ➤ Collaboration with private sector ➤ Management of public transport ➤ Enhancement of publicity 4. Establishment of monitoring and evaluation system <ul style="list-style-type: none"> ➤ Evaluation of each project ➤ Monitoring of area public transport

Source: PPUTMP Project Team

8.1.3 Capacity Development

The Ministry of Public Works and Transport (MPWT) has been conducting training courses every year since 2005 which DPWT personnel attend. The Project has obtained the booklet on this training, and the essential part translated into English and analyzed the training courses. Although there are several sessions in this training course where engineering subjects are covered, these sessions are considered to cover general topics of each field and not designed to teach practical skill or knowledge of engineering, judging from the time spent on each subject. Therefore, the main objective of this training seems to be strengthening of the general knowledge, as government officials, of middle to upper level managers of MPWT and provincial DPWT offices, and not to strengthen any particular fields.

The majority of the participants are senior to middle class managers of MPWT and senior managers of provincial DPWT offices. It is noted that the largest portion of the participants in the first year 2005-06 was senior-level managers such as Deputy Directors of MPWT proper and Directors of provincial DPWT offices, and then has been shifting to middle-level managers. This shift is well understandable if the fact that the number of senior-level managers is rather limited and is considered. If this training course is delivered every year in a sustainable manner, it is expected that junior-level managers will participate in a few years and even engineer-level staff will start to participate within 10 years.

Thus, the delivery of training is considered too slow to manage the current traffic flow under the current vital environment in PPCC and thus the particular fields of training courses should be established by DPWT as soon as possible.

8.2 Analysis on Financial Capacity

8.2.1 Current Public Finance

(1) Current Situation of Fixed Capital Formation of Cambodia

The ratio of Cambodia's gross fixed capital formation (GFCF) to Gross Domestic Product (GDP) in the past decade (2002~2011) was 18.4%, which is lower by 3.7% of the 22.1% average posted by the Association of South-East Asian Nations (ASEAN). The GFCF-to-GDP ratio of Cambodia was also lower by around 10% in comparison with other ASEAN countries that have the same GDP growth rate.

(2) Capital Expenditure of Central Government

According to the expenditure situation of fixed capital of the Cambodian government, of its total expenditure of 2,598 million USD in 2011, 1,171 million USD (45%) was capital expenditure. In this capital expenditure, 840 million USD (72%) was financed by funds from abroad.

(3) Budget of Related Organization and Financing Source for the Master Plan

1) Main entities of the infrastructure development in the Phnom Penh and the Budget

The infrastructure development in Phnom Penh seems to be almost performed by MPWT, DPWT and PPCH, which is described below.

i) MPWT

According to the PUBLIC INVESTMENT PROGRAMME 3-YEAR-ROLLING 2013-2015, MPWT's capital expenditure for 2013 was allotted 603 million USD with an expectation of average expenditure of 606 million USD for 3 years. This represents 37% of total public investment.

ii) DPWT

Although the capital expenditure of DPWT significantly differs each year, it remains at around 2 million USD in the last 3 years.

ii) PPCC

The capital expenditure for road, park, sewage, etc. in Phnom Penh increases by 1.6 times from 23 million USD in 2007 to 37 million USD in 2011.

2) Financing Source for the Master Plan

PPUTMP requires a construction cost of 232 million USD for the short term 2014-2016 (about 77 million USD in a single year), 926 million USD for the medium term 2017-2020 (about 232 million USD for the in single year) and 3,276 million USD for the long term 2021-2035 (about 218 million USD in a single year).

The following table shows total cost in the short- and medium-term, annual average cost and estimated annual budget by organization. Regarding the funding for the short- and medium-term, it would have to be raised as soon as possible.

DPWT and PPCH are estimated to have a 40 million USD infrastructure budget annually in total; however, to execute the projects listed in PPUTMP, DPWT and PPCH will need a yearly budget estimated at 63 million USD. Thus, for the implementation of the PPUTMP, DPWT and PPCH will have to find ways to increase this budget 1.6 times more than the present budget, promoting public-private partnership (PPP), securing an original tax source and receiving a financial support from central government are needed.

MPWT is estimated to have an annual budget of about 400-500 million USD for infrastructure; however, to execute the projects listed in PPUTMP, MPWT is estimated to need an additional 100 million USD annually. Thus on the side of MPWT, it will have to raise this additional fund, promoting PPP, using a soft loan and so on are needed.

Table 8.2-1 Total Cost in a Short and Medium Term (2014-2020), Annual Average Cost, and Estimated Annual Budget by Organization (million USD)

Organization	Total cost in 2014—2020 (X)	Annual average cost (Y=X/7)	Estimated annual budget
DPWT(*1)	438	63	About 40
DPWT	346	49	
PPP	91	13	
MPWT	720	103	About 400~500
MPWT	607	87	
PPP	113	16	
Total	1,158	165	

Source: PPUTMP Project Team

* 1 : The estimated budget for DPWT includes the infrastructure budget of PPCH.

* 2 : Estimated annual budget of MPWT is calculated at 40% of capital expenditure of central government.

9. IMPLEMENTATION PLAN

9.1 Introduction

To materialize the implementation plan of the 2035 Urban Transport Master Plan, the preconditions that include time schedule, project implementation capacity and financial considerations are set up.

9.1.1 Time Frame

The planning period (2014 ~ 2035) is divided in three stages as follows:

- Short-term Planning Period: 2014 ~ 2016
- Medium-term Planning Period: 2017 ~ 2020
- Long-term Planning Period: 2021 ~ 2035

9.1.2 Project Implementation Body and Personnel

The Phnom Penh City Hall (PPCH), the Department of Public Works and Transport (DPWT), the Ministry of Public Works and Transport (MPWT) and the Private Sector are the infrastructure body and personnel currently working toward the implementation of PPUTMP, but mainly with regards to road project implementation. However, this master plan includes not only road projects but also public transport to be newly introduced and traffic management projects. Therefore, human resources of the public sector (PPCH, DPWT and MPWT) should have the administrative and technical capacities for the implementation of PPUTMP projects, with support provided by professional engineers, in accordance with the proposed implementation schedule.

9.1.3 Expected Budget for Phnom Penh's Infrastructure

The total project cost of the 2035 Urban Transport Master Plan for the next 22 years is about 4,564 million USD (207 million USD/year). Of this amount, 2,470 million USD (54% of the total), 2,041 million USD (45%) and 53 million USD are earmarked for public transport, road, and traffic management sector, respectively. This means that more than 50% of the project cost will go to the new type of infrastructure such as public transport.

On the other hand, previous infrastructure development of the transport sector was only road development, and the annual average cost was only 75 million USD. This amount covered not only road but also flood control and other improvements. Considering these circumstances, it is necessary to look into new types of loan framework and to accelerate the positive participation of the private sector.

9.2 Project Cost and Basic Considerations

9.2.1 Public Transport Project

Unit costs for the public transport sector are assumed considering the results of the Preliminary F/S and the 2nd public experiment, and current construction data. The public transport program cost in total, short-term, medium-term and long-term are 2,471 million USD, 3 million USD, 181 million USD and 2,270 million USD, respectively.

Basic considerations for medium-term implementation plan are as follows:

- (1) Completion of the basic bus network including bus priority measures and a mode interchange area such as bus stops and terminals;
- (2) Restructuring the para-transit system; and
- (3) Improvement of existing railway line and water transport.

9.2.2 Road Project

The unit cost of road construction is assumed on the basis of the information from international contractors and average cost of past construction records from DPWT. The road program cost in total, short-term, medium-term and long-term are 2,041 million USD, 196 million USD, 507 million USD and 1,338 million USD, respectively.

Basic considerations for medium-term implementation plan are as follows:

- (1) Widening/rehabilitation of arterial roads;
- (2) Support of public transport service;
- (3) Improvement of bottleneck intersections; and
- (4) Supporting urban development in the suburban area.

9.2.3 Traffic Management Project

The unit cost of construction for the traffic management sector are set considering the current construction data such as sidewalk improvement, result of the public experiments in this project and Japanese examples. The traffic management program cost in total, short-term, medium-term and long-term are 53 million USD, 3 million USD, 23 million USD and 27 million USD, respectively.

Traffic management schemes are mainly for coping with the immediate problem; therefore, all programs/projects should be completed before the medium-term period except for development of off-road parking facilities and soft-components such as traffic demand management.

9.3 Implementation Schedule

The implementation schedule of the three sectors is tentatively assumed as shown in Table 9.4-1.

The schedule can be shifted taking into account the surrounding conditions of each program/project, for example, financial budget, construction pace of related projects, difficulties in land acquisition especially for road sector and other evaluation factors, etc.

9.4 Overall Implementation Plan

Based on the previous discussions, the overall implementation plan is shown below.

Table 9.4-1 Overall Implementation Plan

Code	Package Name	Finance	Length	Project Cost		Short	Medium	Long			
				(Mil. USD)	2014-2016			2017-2020	2021-2025	2026-2030	2031-2035
PP-1	Rail Transit (Phase 1)	Japan Loan	14.0	759.0			189.75	568.5			
PP-2	Rail Transit (Phase 2)	MPWT,DPWT,PPP	30.8	1670.0					835.0	835.0	
PP-3	Bus System (Phase 1)	DPWT,PPP	57	2.9	2.9						
PP-4	Bus System (Phase 2)	DPWT,PPP	91	4.6			4.6				
PP-5	Bus System (Phase 3)	DPWT,PPP	278	13.9				6.95	6.95		
PP-6	Restructuring of the para-transit operation	DPWT	-	Soft Components							
PP-7	Commuter Rail System	MPWT,PPP	19.3	20			20				
PP-8	Improvement of Water Transport	DPWT	11 Jetties	1.1			1.1				
Public Transport Total			490.1	2,471.4	2.9	215.5	575.5	842.0	835.0		
RP-1	Improvement of the City Center Road System	DPWT, PPP, MPWT	17.9	62.6	20.8	1688.1	17.0				
RP-2	Strengthening the Asian Highway (Radial Road System)	DPWT, MPWT	55.5	81.3	39.1	42.2					
RP-3	Strengthening the Asian Highway (Ring Road System, RR-II & RR-III)	DPWT, MPWT, Korea/BOT	81.1	381.0	77.1	162.2	141.7				
RP-4	Strengthening the Asian Highway (Ring Road System, RR-IV)	MPWT	80.8	288.9				144.5	144.5		
RP-5	Southern Radial Arterial Road System Strengthening	MPWT	21.3	55.0				34.0	21.0		
RP-6	Southern Suburban Arterial Road Development	DPWT	36.0	161.6	18.8	37.9	25.2	79.7			
RP-7	Northern Suburban Arterial Road Development	DPWT	20.8	57.2	50.1	7.1					
RP-8	Eastern Suburban Area Road System Improvement	DPWT/PPP	51.7	146.2	31.6	31.6	36.9	46.1			
RP-9	Southwestern Suburban Area Road System Improvement	PPP, DPWT	68.4	221.8		92.8	80.1	48.9			
RP-10	Northwestern Suburban Area Road System Improvement	DPWT, DPWT/PPP	77.7	218.2		47.9	99.9	46.4	24.1		
RP-11	Chinoy Changvar Area Road System Improvement	PPP, DPWT/PPP	47.1	113.5		11.7	29.3	36.3	36.3		
RP-12	Western Peripheral Area Road System Improvement	DPWT/PPP	31.2	57.4					57.4		
RP-13	Flyover/Underpass Project	DPWT	10.4	196.3	15.4	50.2	43.6	43.6	43.6		
Road Total			599.9	2,041.0	252.8	2,171.7	473.7	479.3	326.8		
TP-1	One-way System	DPWT	-	0.3	0.1	0.2					
TP-2	Parking Measures	DPWT,PPP	-	31.2		5.6	8.5	8.5	8.5		
TP-3	Development of Comfortable Pedestrian Environment	Japan Grant,DPWT	-	4.8		4.8					
TP-4	Transit Mall	DPWT	-	0.03		0.03					
TP-5	City Center Traffic Signal Upgrading Project for 100 Intersections	Japan Grant,DPWT,PPP	-	15.0	3.0	12.0					
TP-6	Park and Bus/Rail Ride	DPWT,PPP	-	1.4			0.7	0.7			
TP-7	Mobility Management	DPWT	-	Soft Components							
TP-8	Driver's Education and Traffic Enforcement	DPWT,Traffic Police	-	Soft Components							
Public Transport Total			0.0	52.7	3.1	22.6	9.2	9.2	8.5		
Grand Total			1,090.0	4,565.1	258.9	2,409.7	1,058.4	1,330.5	1,170.3		

Source: PPUTMP Project Team

9.5 Selection of Priority Programs

9.5.1 Basic Considerations for the Evaluation of Priority Programs

In evaluating priority programs, the basic considerations are as follows:

- (1) The high priority programs by sector, the programs which need immediate action (details are in Chapter 10 as the Action Plan) and the program which is the most important in the Master Plan (details are in Chapter 11 as the preliminary F/S), are selected through the evaluation of the various factors affecting the programs by sector, which are discussed in this section.
- (2) The evaluation factors are as follows:
 - 1) Is it effective to decrease traffic congestion, which is the fundamental issue for the urban transport? The evaluation looks at either of the following two viewpoints; namely, 1) to increase the capacity of the transport facility such as road capacity, or 2) to introduce traffic demand management such as introduction of public transport.

- 2) Does it contribute to the MP's Goal, which is to support the 2035 urban vision and urban structure, and Mission, which is to improve the mobility of the citizens and materialize the urban potential?
 - 3) Does it contribute to the formulation of the urban frame, guide a favorable urban development and support the development of the Mekong Sub-region?
 - 4) In addition, the urgency of the program implementation, its contribution to road safety and urban environment and its effective use of the existing transport facilities are also evaluated.
- (3) Each evaluation item is given points: 'OO' for greatly contribute or large positive impact, and 'O' for contribution or positive impact. The evaluation score is obtained by adding up the number of 'O's' received.

9.5.2 Evaluation Results

The evaluation results are tabulated in Table 9.5-1 and explained as follows:

(1) High priority programs by sector

1) Public Transport Sector

The following three programs have the highest priority in the public transport sector and in all M/P programs.

PP-1 and PP-2 (Rail transit implementation, phase 1 and phase 2)

These are large-scale programs to introduce rail transit along the major urban transport corridors with the cost of 2,430 million USD, and it will take more than 20 years to complete. The programs' potential will further improve by the introduction of the bus feeder system and the development of the mode interchange areas.

PP-7 (Development of the commuter train to operate on the existing railway line)

This program is intended to introduce commuter train service on the existing railway line. The advantages of this program are effective use of the existing transport facilities and its low cost, but there are also disadvantages such as low density land use and squatter problems along the railway line.

2) Road Sector

Current development progress of the road sector is high because all of the projects proposed in the JICA 2001 MP on the road sector have been implemented.

RP-2 (Development of the radial trunk road system, NR No. 1, No. 4, No. 5 and No. 6)

This is part of the development of the radial-ring trunk road system which forms the urban frame and strengthens the Asian Highway.

RP-3 (Development of the ring trunk road system such as Ring Road II and III)

This is part of the development of the radial-ring trunk road system which forms the urban frame and strengthens the Asian Highway.

RP-6 (Development of the inner city trunk road system: Southern suburban area)

This program aims to guide land use patterns in the southern suburban area where rapid urbanization is on-going.

RP-7 (Development of the inner city trunk road system: Northern suburban area)

This program aims to guide land use patterns in the northern suburban area where rapid urbanization is on-going.

3) Traffic Management Sector

From among the programs for the traffic management section, the following three programs have priority:

TP-3 (Improvement of the sidewalk in the city center)

A comfortable sidewalk contributes to the opportunity of re-introducing walking as a mode of transport to citizens to increase the public transport users and the vitality of tourism in Phnom Penh.

TP-5 (100 signalized intersections upgrading)

This program contributes not only to securing smooth traffic flows in the city center but also to performing more effective traffic improvements together with development of related measures such as intersection and sidewalk improvements. It is expected that support will be provided by the Japanese ODA.

TP-7 (Traffic Demand Management)

This program is given the highest priority among the traffic management sector programs. As a traffic countermeasure, it is used to influence and change the travel needs of people in order to make efficient use of existing roadway, thereby reducing traffic congestions, improving traffic safety, saving fuel consumption, and finally, reducing vehicle emissions. However, changing citizen consciousness toward urban transport is one of the most difficult challenges to improving the traffic situation in PPCC.

(2) Urgent Programs (to Short- and Medium-term Action Plan)

An evaluation was made of 11 programs for urgent implementation within the short- and medium-term period. Programs (excluding soft component) with a score of 12 points are PP-3 & PP-4 (City bus operation program, phases 1 and 2) from public transport sector and TP-5 (100 signalized intersections upgrading) from the traffic management sector. These programs need the implementation of the action plan described in Chapter 10 for them to materialize as soon as possible.

(3) The Highest Priority Program Among MP Programs (to preliminary F/S)

The program that needs more study in the preliminary F/S is **PP-12 (Development of the rail transit system)** which has the highest priority among the MP programs.

Table 9.5-1 Selection of Priority Programs

Public Transport

Code	Package Name	Program Cost (Mil. USD)	Decrease of Traffic Congestion		Improvement of Mobility to PP Citizens	Contribution to the Urban Vitality		Contribution to the Smooth Access between Mekong Subregion's Cities	Strengthening the Urban Axis	Effectively Use of the Existing Transport Facility	Contribution to the Road Safety	Emergency to the Phnom Penh City	Contribution to the Urban Environment	Overall Evaluation	Ranking by Sector	Ranking for Short & Medium-term Action Plan	Overall Ranking for Pre F/S
			Increase of Capacity of the Transport Facility	By Traffic Demand management		Maintain the Current Urban Vitality	Create New Urban Vitality										
PP-1	Rail Transit (Phase 1)	759.0	OO		OO	OO	OO		OO		OO	O	OO	15	1		1
PP-2	Rail Transit (Phase 2)	1670.0	OO		OO	OO	OO		OO		OO		OO	14	2		2
PP-3	Bus System (Phase 1)	2.9	OO		OO	OO	O				OO	OO	O	12	4	1	5
PP-4	Bus System (Phase 2)	4.6	OO		OO	OO	O				OO	OO	O	12	4	1	5
PP-5	Bus System (Phase 3)	13.9	OO		OO	O	OO				OO		O	10	6		12
PP-6	Restructuring of the para-transit operation	Soft Components	O		O	O	O			OO	O	OO	O	10	6		12
PP-7	Commuter Rail System	20.0	OO		OO	O	OO				OO	O	OO	14	2		2
PP-8	Improvement of Water Transport	1.1	O		O		O						O	7	8		21

Pre F/S
Action Plan for
City Bus
Operation

Road

Code	Package Name	Program Cost (Mil. USD)	Decrease of Traffic Congestion		Improvement of Mobility to PP Citizens	Contribution to the Urban Vitality		Contribution to the Smooth Access between Mekong Subregion's Cities	Strengthening the Urban Axis	Effectively Use of the Existing Transport Facility	Contribution to the Road Safety	Emergency to the Phnom Penh City	Contribution to the Urban Environment	Overall Evaluation	Ranking by Sector	Ranking for Short & Medium-term Action Plan	Overall Ranking for Pre
			Increase of Capacity of the Transport Facility	By Traffic Demand management		Maintain the Current Urban Vitality	Create New Urban Vitality										
RP-1	Improvement of the City Center Road System	4.5	O			OO					O	OO	O	7	7	11	21
RP-2	Strengthening the Urban Framework and Asian Highway (Radial Road System)	11.6	OO				OO	OO	OO		O	O	O	11	1		8
RP-3	Strengthening the Urban Framework and Asian Highway (Ring Road System, RR-II & RR-III)	18.1	OO				OO	OO	OO		O	O	O	11	1	4	8
RP-4	Strengthening the Urban Framework and Asian Highway (Ring Road System, RR-IV)	28.9	OO				O	OO	OO		O		O	9	5		15
RP-5	Southern Radial Arterial Road System Strengthening	5.5	OO				O		OO		O		O	7	7		21
RP-6	Southern Suburban Arterial Road Development	13.5	OO			OO	OO		OO		O	O	O	11	1	4	8
RP-7	Northern Suburban Arterial Road Development	14.3	OO				OO		OO		O	OO	O	10	4	7	12
RP-8	Eastern Suburban Area Road System Improvement	12.2	O				OO				O		O	5	10		26
RP-9	Southwestern Suburban Area Road System Improvement	10.1	O				OO				O	O	O	6	9		25
RP-10	Northwestern Suburban Area Road System Improvement	5.7	O				OO				O		O	5	10		26
RP-11	Chruoy Changvar Area Road System Improvement	6.7	O				OO				O		O	5	10		26
RP-12	Western Peripheral Area Road System Improvement	11.5	O				O				O		O	4	13		29
RP-13	Flyover/Underpass Project	8.5	OO			O	OO				O	OO	O	9	5	8	15

Traffic Management

Code	Package Name	Program Cost (Mil. USD)	Decrease of Traffic Congestion		Improvement of Mobility to PP Citizens	Contribution to the Urban Vitality		Contribution to the Smooth Access between Mekong Subregion's Cities	Strengthening the Urban Axis	Effectively Use of the Existing Transport Facility	Contribution to the Road Safety	Emergency to the Phnom Penh City	Contribution to the Urban Environment	Overall Evaluation	Ranking by Sector	Ranking for Short & Medium-term Action Plan	Overall Ranking for Pre
			Increase of Capacity of the Transport Facility	By Traffic Demand management		Maintain the Current Urban Vitality	Create New Urban Vitality										
TP-1	One-way System	0.3		OO		OO					OO	OO	O	9	4	8	15
TP-2	Parking Measures	31.2		OO		OO					OO	OO	O	9	4	8	15
TP-3	Development of Comfortable Pedestrian Environment	4.8		O	OO						OO	OO	OO	11	3	4	8
TP-4	Transit Mall	0.03		O	OO	OO					OO		OO	9	4		15
TP-5	City Center Traffic Signal Upgrading Project for 100 Intersections	15.0		OO	OO	OO					OO	OO	OO	12	2	1	5
TP-6	Park and Bus/Rail Ride	1.4		OO	O		OO				OO		O	8	7		20
TP-7	Mobility Management	Soft Components		OO	OO	OO	OO				OO	OO	OO	14	1		2
TP-8	Driver's Education and Traffic Enforcement	Soft Components		O							OO	OO	OO	7	8		21

Action Plan for
100 Traffic Signal
Intersections
Upgrading

Note OO Has High Impact
O Has Impact
Program needs Urgent Action (Mainly Short- and Medium-term Project)
Some Project in the Program already Started.
Including Sidewalk Improvement

Excluding Soft Component

10. ACTION PLAN

10.1 Introduction

The action plan in this MP defines the target, actions, period and related agencies of the key programs to materialize the medium-term plan of the PPUTMP.

Selected action plans in this chapter are Action Plan 1: Introduction of City Bus and Action Plan 2: Comprehensive Traffic Management Plan in the City Centre (100 signalized intersections upgrading), which are evaluated as urgent programs in section 9.5.

Coordination between Action Plans 1 and 2 is important to more effectively materialize the urban transport plan especially in the city centre.

10.2 Action Plan 1: Introduction of City Bus System

To materialize the city bus system as the trunk public transport system in Phnom Penh in medium-term period, the following measures are implemented.

10.2.1 Short- and Medium-term Schedule

The short- and medium-term schedule for the introduction of city bus system is shown in Figure 10.2-1.

Items	Related Organization	Short-term Planning Period				Medium-term Planning Period				
		2014			2015	2016	2017	2018	2019	2020
		Jan-Mar	Apr-Aug	Sep-Dec						
Public Experiment	DPWT PPCH JICA Private Sector	1 Bus Route								
Public (Management & Operation)	PTMD Private Sector		1 Bus Route							
Public (Management), Private (Operation)	PTMA			3 Bus Routes	5 Bus Routes	10 Bus Routes				

Source: PPUTMP Project Team

Figure 10.2-1 Short- and Medium-term Schedule of the Action Plan 1

10.2.2 Implementation Goal for Short- and Medium-term Plan

The implementation goal for the city bus system is as follows:

- Implement 5 bus routes until 2016 (Short-term period)
- Implement 10 bus routes until 2020 (Medium-term period)

10.2.3 Long-term Goal

- The bus system will be restructured to play the role as the feeder system of rail transit along the urban transport corridors and as the trunk public transport system in the suburban area after the introduction of the rail transit in the long-term period.

10.3 Action Plan 2: Comprehensive Traffic Management Plan in the City Center

The following comprehensive traffic management measures will be implemented for securing the smooth flow of traffic in the city centre with effective use of the limited urban transport space.

10.3.1 Short- and Medium-term Schedule

The short- and medium-term schedule of Action Plan 2 is shown in Figure 10.3-1.

Items	Related Organization	Implementing Organization	Short-term Planning Period			Medium-term Planning Period			
			2014	2015	2016	2017	2018	2019	2020
Traffic Signal Upgrading	Traffic Signal Upgrading	JICA & DPWT	■			■			
	Intersection Improvement	JICA & DPWT				■	■		
	Sidewalk Improvement (Major Roads)	DPWT				■	■		
Sidewalk Improvement (Secondary Roads)		DPWT				■	■	■	
Introducing One-way System		DPWT				■	■	■	
Parking Measures	Major Roads	DPWT				■	■	■	■
	Secondary Roads	DPWT				■	■	■	■
	Off-road Parking, etc.	DPWT				■	■	■	■
Driver's Education and Traffic Enforcement		NRSC & Traffic Police		■	■	■	■	■	■

Source: PPUTMP Project Team

Figure 10.3-1 Short- and Medium-term Schedule of the Action Plan 2

10.3.2 Implementation Goal for Short- and Medium-term Plan

The following is the implementation goal for the short term and medium term

- 70% of 100 signalized intersections will be improved until 2016
- 100 signalized intersections will be improved until 2017
- Sidewalks will be improved along the trunk roads including near improved intersections be the 100 signalized intersections upgrading project from 2017 to 2018

10.3.3 Long-term Goals

Following are the long-term goals:

- To install new traffic signals as required(considering the change of traffic volume in the city center)
- To install new traffic signals at intersections of newly developed urban area in the suburban area.

11. PRELIMINARY FEASIBILITY STUDY ON RAIL TRANSIT SYSTEM FOR EAST-WEST CORRIDOR

11.1 Introduction

The rail transit system along the major transport corridors that connects the city center and the Northern/Southern and Western suburban areas is selected as the priority project in the Master Plan.

Prior to respective work in the preliminary F/S, identified common items are discussed as shown below.

- ✓ Target Public Transport Corridor and Selection of the Route
 - 1) North-south transport corridor along Monivong Blvd., 2) east-west transport corridor along Russian Blvd. and 3) southwest transport corridor along Charles de Gaulle and Monireth Blvd.
- ✓ Physical space adopted for transit system introduction

It is considered that the public space such as existing/planned transport space (road or railway) is utilized as the space for system introduction.
- ✓ Type of Infrastructure

It is assumed that the infrastructure of the public transport system is elevated or underground type except for at-grade sections where circumstances can allow it.
- ✓ Public Transport System

Based on the Master Plan study, which was analyzed in the 2nd phase, medium-capacity rail transit systems with capacity from 4,000 to 7,000 passengers/hour/direction is selected as the target public transport system
- ✓ Construction and Operation Method

It is selected the construction and operation method considering the economic conditions in Cambodia and examples in other cities in Southeast Asia.

11.2 Analysis on Target Public Transport Corridor

11.2.1 Target Public Transport Corridor

Based on examination of the three primary public corridors, i.e. 1) South-north corridor, which passes through Monivong Blvd. and consists of 3 sub-corridors, 2) East-west corridor, which passes through Russian Blvd., and 3) Southwest Corridor, which passes through Monireth Blvd., corridors including western area, namely, 2) East-west Corridor and 3) Southwest Corridor have been selected. Several route alternatives were also prepared and necessary analysis conducted with the outcome shown below:

- i. A relatively high passenger demand of around 72,500 to 81,600 trips/day is expected in 2035.
- ii. The route connects between urban central district, and western fringe area where urbanization is in progress.
- iii. The route connects with several intense traffic generation nodes, i.e. Phnom Penh airport, train depot and bus terminal facilities (future plan).
- iv. A large-scale private development plan for the central district is underway, e.g., Boeng Kak lake development plan.
- v. Various land use patterns are seen along the corridor.
- vi. It is possible to serve future transport demand by bus feeder network from south and north sectors where area development will be expected in the future.

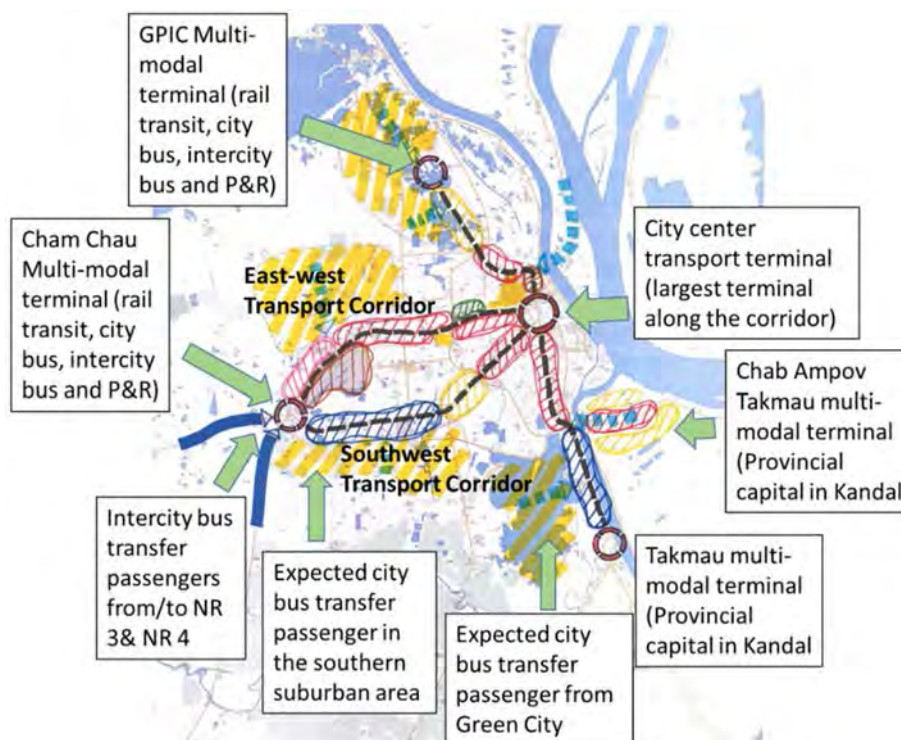

Source: PPUTMP Project Team

Figure 11.2-1 Corridor Characteristics

11.2.2 Preparation and Evaluation of Route Alternatives

Based on cost, urban environment, passenger demand potential, distribution of densely populated areas, maximized use of the existing transport facility, 4 alternative routes were prepared as shown in Figure 11.2-2.



Source: PPUTMP Project Team

Figure 11.2-2 Route Alternatives for East-West and Southwest Transport Corridors

The optimum route for preliminary F/S was selected from the above-mentioned 7 alternatives through the evaluation on the following 9 viewpoints. Each evaluation item was given points: 3 for good, 2 for fair and 1 for worse. However, since cost is the most important item for the route evaluation, the points it received was multiplied by 2.

- i. Cost
- ii. Passenger demand in 2035
- iii. Existing land use along the route
- iv. Accessibility to Pochentong Airport
- v. Future Urban Development along the Route
- vi. Possibility of Future Expansion of the System
- vii. Urban Environment (Issue pertaining to urban scenery)
- viii. Issues of VIP traffic
- ix. Issues of land acquisition

The result of evaluation is shown in Table 11.2-1.

Alternative 1 received the most points as shown in Table 11.2-1; still, further discussions was necessary especially on the issue of VIP traffic.

Table 11.2-1 Comparison of Evaluation for Route Alternatives

Items		Alternative 1	Alternative 2	Alternative 3-1	Alternative 3-2
		Russia Blvd. route	Railway - Russia route	CDG - Monireth - Veng Sreng Blvd. route	
		Monivong Blvd.- MRD (Russia, underground) MRD - Depot (Russia, elevated)	Central Station - Depot (Railway line and Russian Blvd. Elevated)	Olympic Stadium - Monireth (CDG and Monireth, Elevated) Monireth - Airport (Monireth, Veng Sreng and Russia, Elevated)	Central Market - Depot (CDG, Monireth, Veng Sreng and Russia, Elevated)
Length of elevated and underground section (km)	Elevated Section	11.8	14.2	12.0	16.3
	Underground Section	2.2	0.9	0.9	0.9
	Total	14.0	15.1	12.9	17.2
Cost (Million USD)		759	645	586	733
		2	4	6	2
2035 Passenger Demand (Passengers/Day)		81,600	72,500	75,000	79,000
		3	1	1	2
Land use along the route		3	1	3	3
Accessibility to the airport		3	3	1	1
Future development along the route		3	1	3	3
Future Extension		3	1	3	1
Urban environment (urban scenery)		3	3	2	1
Issue to the VIP Traffic		1	3	3	3
Issue of ROW		3	2	1	3
Overall Evaluation		24	19	23	19

Source: PPUTMP Project Team

Based on the overall evaluation of the above 4 alternatives and discussions with relevant agencies, the following 3 route alternatives were presented for further discussion with stakeholders such as members of the Technical Committee and those of the Steering Committee.

For the more detailed study conducted for Alternative 1, please refer to Appendix 3.



Source: PPUTMP Project Team

Figure 11.2-3 Route Characteristics by Alternative

12. Conclusion and Recommendation

12.1 Conclusion

■ A Quick Look at the Master Plan (Outline of the Master Plan)

The Urban Transport Master Plan proposed in this project was based on the analysis of current transport characteristics including person trip survey and the future vision formulated through the discussion with stakeholders.

A two-fold approach to urban transport planning adopted; namely, (1) reorientation of transport mode from private to public, and (2) introduction of traffic demand management, which is an attempt to balance the increase in demand and supply within the environmental limitations such as urban land and financial constraints.

Considering this approach, the road system, which forms the urban framework, was formulated comprising a radial-ring trunk road network system, and the road network plan was developed to cope with the urban development in the suburban area.

Meanwhile, in the city centre, to maximize the limited transport space, comprehensive traffic management measures were introduced, and these include traffic signal system improvement, one-way system, parking measures and pedestrian environment improvement.

The above-mentioned plans and development are in support of the public transport system comprising rail transit and its feeder bus system, which is intended to spur the creation of the new Phnom Penh, offering convenience to better appreciate the charm of the city. And the restructuring of the existing public transport systems such as para-transit, railway and water transport, together with the above-mentioned new public transport system, can trigger a shift in modal choice from private to public transport and create a comfortable and vital urban environment with high mobility.

The commodity transport system was also developed as it is an important infrastructure supporting the economic activities and daily life of the citizens in Phnom Penh. Furthermore, an appropriate urban transport-related organization and financial system was formulated for sustainability.

Twenty-nine (29) programs, integrated from 68 projects, are proposed, and the total project cost is about 4,564 million USD. Of this amount, 2,470 million USD (54% of the total), 2,041 million USD (45%) and 53 million USD are earmarked for public transport, road, and traffic management sector, respectively.

The economic internal rate of return (EIRR) is 18%, and it can be judged that the master plan investment is feasible to Cambodia based on the 30% of total trips shifting to public transport mainly from such private modes as cars and motorcycles. This is a big challenge for Phnom Penh, but at the same time, it promises big gains in the creation of a better Phnom Penh.

On the other hand, previous infrastructure development of the transport sector was only road development, and the annual average cost was only 75 million USD. This amount covered not only roads but also flood control and other infrastructure improvements. Considering these circumstances, it is necessary to look into new types of loan framework and to accelerate the positive participation of the private sector.

■ Project Recommendation and Other Issues and Actions

Two public experiments were implemented from the two themes of the main urban transport issues, which are (1) reorientation from private to public transport: introduction of city bus operation, and (2) maximization of the use of limited urban space: implementation of comprehensive traffic management plan including one-way system expansion. After the public experiments, things moved quickly and smoothly with the (1) management of the city bus operation being handed over to PTMA, and (2) the preparatory survey for the development of traffic management system in Phnom Penh by JICA having been carried out.

The master plan formulation by back-casting with stakeholder participation was also examined. Back-casting is a method of setting the future vision with the participation of relevant people considering various alternatives. Then, that future vision or plan will be implemented through careful thought and analysis. The development of the 2035 future vision in Phnom Penh is a product of collaborative work of back-casting and shared vision among the stakeholders.

This master plan project also supports the urban transport-related business opportunities for Cambodian and Japanese private sector through the meetings with stakeholders and with the Japanese Business Association of Cambodia (JBAC). City bus operation and the traffic management system project have already been materialized and the development of a rail transit system is also expected in the near future.

12.2 Recommendation

■ Priority Project Recommendation (Short- and Medium-term Action Plans and pre F/S)

• Action Plans

Two proposed short- and medium-term action plans have already started. However, there are two key issues need to be addressed in order to attain the 2020 goal and these pertain to bus operation and traffic management.

With regards to bus operation, there should be capacity development for PTMA staff to ensure the efficient running of the bus. In addition, a way must be found for the effective participation of the private sector in the bus operation to cope with the increase in bus routes to 10, covering 148 km, before year 2020.

As for traffic management, there should be a comprehensive plan that includes developing on-road parking measures for local roads and improving the sidewalk circumstances together with upgrading of 100 signalized intersections as soon as possible. One idea is to start with citizens participation one pilot road, say Street 240, as a model road in Phnom Penh.

• Pre-feasibility Study

A pre-feasibility study (pre-F/S) was conducted for the rail transit, which was proposed as the future trunk public transport in Phnom Penh and recommended as the highest priority project in the master plan. In the pre-F/S, the Project team studied the preliminary route alternatives (4 alternatives were proposed and

evaluated but the final route has yet to be decided due to the many discussions still to be held among stakeholders regarding the rail transit system), passenger demand, project cost, economic and financial analysis and conceptual study of the organization. For the materialization of the rail transit system, it is necessary to conduct a feasibility study (this is a more detailed study than the pre-F/S) to determine the final route alignment, produce a detailed passenger demand, making basic design, cost estimation, economic/financial analysis and decide on the implementing organization as soon as possible after completion of this master plan. The urgency of this matter is owed to the increasing traffic demand every day and the implementing period, which is more than 5 years after the feasibility study.

■ Government Approval of the Master Plan

For the materialization of the 2035 Urban Transport MP in the Capital City, the cooperation of not only PPCH but also MPWT (on the government side) is necessary. Therefore, the official approval of the government is the precondition for the urban transport master plan's materialization.

The Urban Master Plan in 2020 for PPCH, which was completed in 2009 funded by the French government, has been undergoing the process of government approval for almost 5 years now through consultation with NCLMUP, and its final approval is expected in 2014. Meanwhile, NCLMUP made the recommendation to proceed with the formulation of the 2035 Urban Master Plan, which entails updating of the 2020 Urban Master Plan after the government approval of the 2020MP. With this recommendation from the government, PPCH planned the formulation of an integrated 2035 Urban Master Plan including the 2035 Urban Transport Master Plan supported by JICA. PPCH will then submit and request for government approval of Phnom Penh's 2035 Comprehensive Urban Master Plan.

■ Secure the Right-of-way of the Trunk Road Network

The radial-ring trunk road network forms the physical framework in PPCC. Therefore, it is essential to secure the right-of-way of trunk roads for the PPUTMP completion as soon as possible, even though it will take time to proceed with the road improvement/construction.

■ Establishment of Urban Transport-related Organization

City bus operation was introduced and started in 2014, and the PTMA has been created as the management agency of the city bus operation. However, having a newly created agency is not enough; PTMA should be given a mandate to implement the traffic management measures such as parking measures and sidewalk improvement, which are directly related to having a smooth bus operation. However, PTMA's management/operation capacity is still poor, and it is necessary to include the participation of the private sector to cope with the 2020 bus route network plan. The key to sustaining the bus operation lies in strengthening the bus operation capability of PTMA and the timing of the private sector participation.

On the other hand, as the first step for the new organizations (PPUTA) to manage the rail transit, it is advisable that MPWT first this; because, the current railway department will have to be restructured and its management/operating capabilities strengthened for the new transit system. Besides, a foreign loan can only be availed of by a government entity. It is also advisable that PTMA and PPUTA be merged as an

autonomous urban transport management agency after the transit system starts operating.

The Project team has recommended the following responsibilities and process of merger of PTMA and PPUTA.

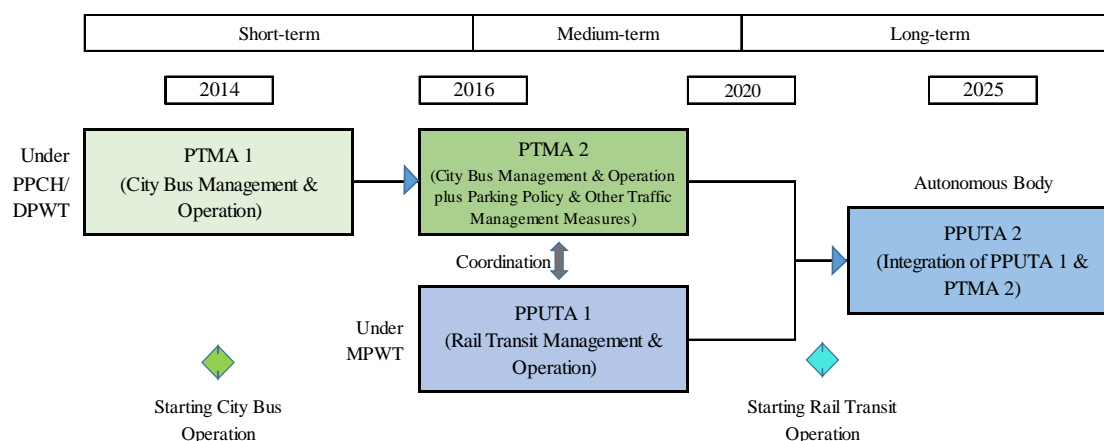

Note: Public Transport Management Authority (PTMA) and Phnom Penh Urban Transport Authority (PPUTA)

Source: PPUTMP Project Team

Figure 12.2-1 Recommended Responsibilities and Process of Merger between PTMA and PPUTA

■ Necessity of Master Plan Monitoring and Revised Plan Roll-Out by Stakeholder Participation

It is necessary to continue the activity of the stakeholder group that was organized during the master plan study and request its participation in checking the progress of the master plan implementation in collaboration with PPCH. At the same time, it is recommended to maximize the use of the stakeholder group and activities to raise citizen’s awareness of modal use from private to public transport to citizens using the mobility management scheme.

To flexibly respond to the unstable socio-economic circumstances in Phnom Penh, it is necessary to conduct a periodic revision to fill the gap between current conditions and plan. Therefore, it is essential that plans are rolled out every 5 or 10 years and that PDCA (Plan -> Do -> check -> Action->) is conducted to secure the sustainability of implementation of the urban transport plan.

APPENDIX

TABLE OF CONTENTS

	Page No.
1. 1 st PUBLIC EXPERIMENT	A-1
1.1 Outlines of the Experiment	A-1
1.2 Results of the Experiment	A-2
1.3 Summary	A-4
1.4 Recommendations	A-5
2. 2 nd PUBLIC EXPERIMENT	A-6
2.1 Public Experiment on Bus Operation	A-6
2.2 Results of the Experiment	A-7
2.3 The Future of Public Transport	A-9
3. PRE-FEASIBILITY STUDY	A-12
3.1 Demand Forecast of Target Transit System	A-12
3.2 Proposed Rail Transit System	A-14
3.3 Most Suitable Railway System Routs and Selection of Depot Location	A-17
3.4 System Operation Plan	A-18
3.5 Preliminary Facility Plan	A-19
3.6 Economic and Financial Analysis	A-22
3.7 Environmental and Social Consideration	A-24
4. VERIFICATION OF TARGET PUBLIC TRANSPORT MODAL SHARE IN 2035	
BASED ON SP SURVEY	A-25
4.1 Introduction	A-25
4.2 Overall Work Procedure	A-25
4.3 Survey Method (SP Survey for Current Mode Users and Bus Passenger Interview	
Survey)	A-26
4.4 Conduct of SP Survey	A-26
4.5 Comparison between Two Survey Results (Interviewee’s Characteristics and	
Awareness of Modal Choice)	A-28
4.6 Analysis of SP Survey for Developing the Logit Model	A-30
4.7 Estimation of Public Transport Modal Share in 2035	A-31

List of Figure

	Page No.
Figure 1.1-1	First Public Experiment Coverage AreaA-2
Figure 1.2-1	Comparison of Rates of Defying Vehicles on the One-way Traffic Rule Before And During the Experiment.....A-2
Figure 1.2-2	Increase in Usage of Pedestrian Sidewalks (Total on all Routes).....A-3
Figure 1.2-3	About the Parking Regulation.....A-3
Figure 1.2-4	Impression about the SidewalkA-3
Figure 1.2-5	About One-way System.....A-4
Figure 1.2-6	Results of Parking Survey (Passenger car and motoreumok modern).....A-4
Figure 1.4-1	Road Space UsageA-5
Figure 2.1-1	Bus Route.....A-6
Figure 2.1-2	Three Target Intersections along Monivong Blvd.A-6
Figure 2.2-1	Number of Alighting and Boarding Bus Passengers by Bus Shop A-7
Figure 2.2-2	Travel Time Survey Route and Location of 3 Systematized Traffic Control Signals Intersections A-7
Figure 2.2-3	Distance from Your Place to the Bus Stop..... A-8
Figure 2.2-4	Acceptable Level of Bus Fare..... A-8
Figure 2.2-5	Most Important Feature of Public Transport in Future to Citizens A-8
Figure 2.2-6	Opinions of Residents if Bus Stops being Installed Near Their Homes A-8
Figure 2.2-7	Front Page News Report on the Phnom Penh Post..... A-9
Figure 2.2-8	Facebook of Public Experiment..... A-9
Figure 3.1-1	Flow-chart of Estimating Corridor-Base Passengers..... A-12
Figure 3.1-2	Location of Each Station..... A-13
Figure 3.3-1	Outline of Alignment and Route Profile A-17
Figure 3.4-1	Image of Vehicle A-18
Figure 3.5-1	Two Box Tunnel..... A-19
Figure 3.5-2	One Box Tunnel..... A-19
Figure 3.5-3	Elevated Station 1 A-20
Figure 3.5-4	Elevated Station 2 A-20
Figure 3.5-5	Image of Power Supply Diagram (in Case of 2 Bulk Substations)..... A-20
Figure 3.5-6	Image of Contact Line of AGT A-21
Figure 3.5-7	General Configuration of Automatic Train Protection..... A-21
Figure 3.5-8	Schematic Diagram of Signaling System A-22
Figure 3.5-9	General Configuration of Telecommunication System..... A-22
Figure 3.6-1	Result of Sensitivity Analysis of Phnom Penh East-West Line A-23
Figure 4.4-1	Survey Locations (3 Bus Routes and 4 Mall/Markets) A-27

Figure 4.5-1	Awareness Survey of Modal Choice.....	A-29
Figure 4.7-1	2035 Transport Network in Project Area.....	A-31
Figure 4.7-2	Urban Rail Transit and Bus Coverage Area.....	A-32
Figure 4.7-3	Zoning Map and Current Bus Routes in Phnom Penh.....	A-33
Figure 4.7-4	Number of Annual Vehicle * km per Hectars vs Public Transport Market Share.....	A-33
Figure 4.7-5	Result of the Sensitivity Analysis.....	A-35

List of Tables

	Page No.
Table 1.1-1	One-way Traffic Experimental Routes and Directional Flow..... A-1
Table 2.3-1	Estimation of Operation Costs..... A-9
Table 2.3-2	Profile of the Bus Users..... A-10
Table 3.1-1	Trip Matrix between Stations in 2035..... A-13
Table 3.1-2	Sectional Passenger Volume between Stations..... A-13
Table 3.2-1	Outline and Specifications of Candidate Public Transport System..... A-15
Table 3.2-2	Elevation of the Rail Transit System Alternatives..... A-16
Table 3.3-1	Design Standard for AGT Planning..... A-17
Table 3.4-1	Main Specifications of AGT..... A-18
Table 3.4-2	Train Operation Plan at Peak Hour and Calculation of Required Number of Train-sets/Vehicles..... A-19
Table 3.6-1	Summary of Economic Analysis..... A-23
Table 3.6-2	Summary of Financial Analysis..... A-23
Table 3.7-1	Summary of Social Impact..... A-24
Table 3.7-2	Summary of Natural Environmental Impact..... A-24
Table 4.5-1	Consciousness Survey Results..... A-29
Table 4.6-1	Estimation of Modal Parameters..... A-30
Table 4.7-1	Criteria of the Shortest Route Research..... A-31
Table 4.7-2	Summary of RP-Based PT Transferred Trip and Share..... A-34
Table 4.7-3	Comparison of PT Transferred Trip and Share between SP Based and RP Based..... A-34
Table 4.7-4	Estimation of the Number of Public Transport Trip and Modal Share in 2035 in Comparison between Before and After Correction..... A-34
Table 4.7-5	Conditions and Cases by the Influence Factor for the Sensitivity Analysis..... A-35

APPENDIX

1. 1ST PUBLIC EXPERIMENT

1.1 Outlines of the Experiment

1.1.1 Objective of the Experiment

The Phnom Penh Capital City (PPCC) is currently facing a series of urban transport problems. Severe traffic congestion has resulted in a general decline of travel speeds. Unlawful parking of vehicles on pedestrian sidewalks has forced the pedestrians to use the roadways instead.

One of the city's strategies to cope with this problem is to improve the road transport environment by utilizing the city's limited road traffic space in a most effective manner while ensuring a pedestrian friendly urban centre.

Based on such a development direction aimed at overcoming the various existing urban transport problems, the implementation of many new countermeasures by the city government has become inevitable. Such future countermeasures would surely include, among others, 'a traffic management plan for PPCC that centres on the implementation of a city-wide one-way traffic circulation system', 'development of a pedestrian network to further enhance the convenience and usage of the public transport system', and 'a pedestrian network system in response to the increase in tourists in the city'.

Therefore, prior to implementing such countermeasures, it is essential that they are tested for their possible impacts and effectiveness at specific locations and time periods with the participation of the local residents. Notwithstanding the fact that these countermeasures are aimed at solving the urban transport problems of PPCC, the objective of this test or 'Public Experiment' is therefore to assist the authorities and local residents in deciding whether to fully implement such countermeasures.

<Time Period for the First Public Experiment>

27th February 2013 (Wednesday) – 3rd March 2013 (Sunday) for a total of 5 days.

1.1.2 Coverage Area for the Public Experiment

From the perspective on a need to form a tourist pedestrian network, the eastern section of the major arterial road of Norodom was selected for the experimental implementation of 'a one way traffic operation' (yellow coloured area shown in Figure 1.1-1).

In principle, one-way traffic operation is most suitable for any pair of parallel roads that are close to each other and which have serious traffic congestions. However, if such pair of roads is too far apart, then the detour distances become too long. In general, if the separating distance between the roads is about 300 metres, and the directions of travel are not in conflict with any existing one-way circulation system, then such pairs of roads can be selected for the operation of one-way traffic measure.

As a result of such considerations, the following road sections are selected for the Public Experiment on one-way traffic operation.

<One-way Traffic Experimental Routes>

Table 1.1-1 One-way Traffic Experimental Routes and Directional Flow

St. No.	One way direction	Section
St. 130	WEST←EAST	Sothearos-Norodom
St. 136	WEST→EAST	Norodom-Sothearos
St. 154	WEST←EAST	Sothearos-Norodom
St. 178	WEST→EAST	Norodom-Sothearos East

Source: PPUTMP Project Team

In addition, for the convenience of tourists who move around on foot, pedestrian sidewalks that link up the major tourist spots forming a network (as indicated by the green dash lines in the Figure 1.1-1) are

first identified. Such a network was then selected with a public announcement specifying that portions of these sidewalk spaces were to be vacated as pedestrian walking space for the Public Experiment. The coverage area for the First Public Experiment on Traffic Countermeasures is shown in Figure 1.1-1.

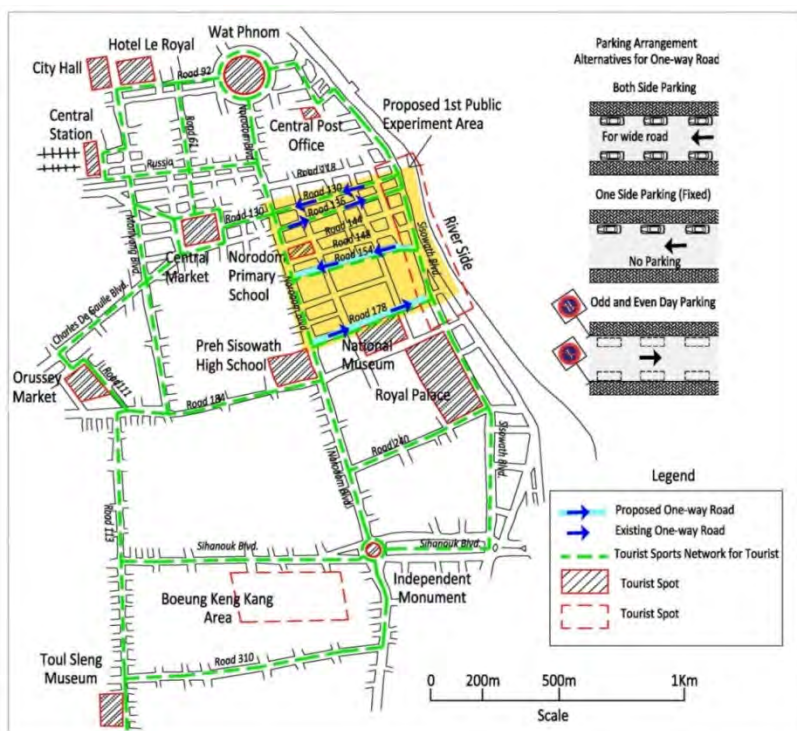

Source: PPUTMP Project Team

Figure 1.1-1 First Public Experiment Coverage Area

1.2 Results of the Public Experiment

1.2.1 Results of Vehicular Traffic Volume Survey

(1) Traffic Volume

Compared to Pre-Experiment traffic volumes, traffic volumes on the Experiment days actually show a slight decrease in total numbers. However, the Experiment has no major adverse effects on the traffic conditions.

(2) Vehicles that Defy the One-Way Traffic Rule

In analysing the percentage of vehicles which defy the one-way traffic rule to the total traffic volumes on both St.130 and St.136 which are both under the existing one-way traffic operation system, there was a slight decrease during the Experiment when compared to the Pre-Experiment situation. Nevertheless, there was still 20% of defying vehicles on these two routes.

(3) Composition of Defying Vehicles to the One-way Traffic Rule

80% of the defying vehicles to the one-way traffic rule are motorbike/Motodop.

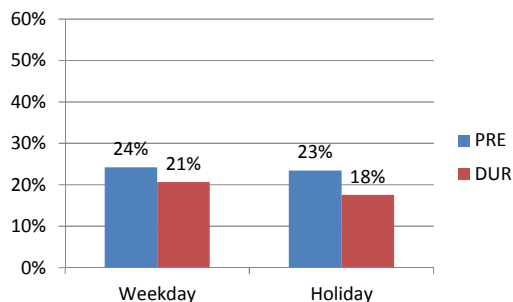

Source: PPUTMP Project Team

Figure 1.2-1 Comparison of Rates of Defying Vehicles on the One-way Traffic Rule Before and During the Experiment

1.2.2 Results of Pedestrian Traffic Volume Survey

Results of the pedestrian traffic volume surveys on all the experimental 4 routes showed that while 37.6% of the total pedestrian volume used the sidewalks before the Experiment, this rate has increased to 59.9% during the Experiment. The positive effect on the usage of pedestrian sidewalks by the countermeasure was thus verified by these results.

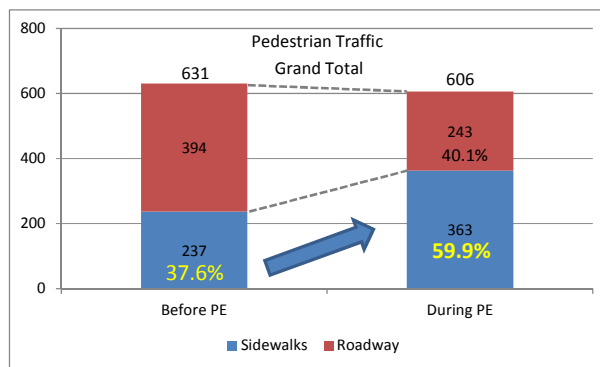

Source: PPUTMP Project Team

Figure 1.2-2 Increase in Usage of Pedestrian Sidewalks (Total on all Routes)

1.2.3 Result of Interview Survey

(1) Resident & Shop owner

73% of the residents and shop owners answered that parking regulation should be continued.

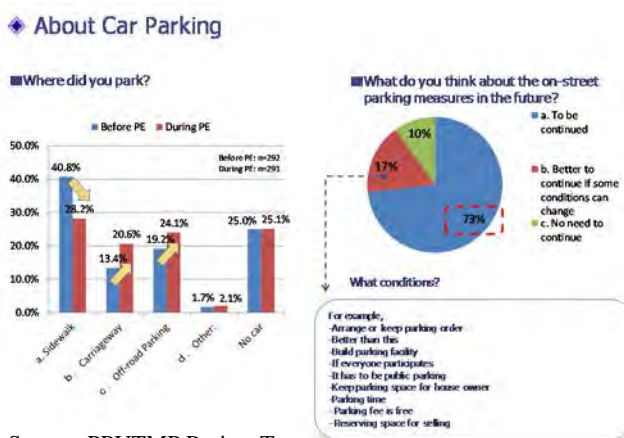

Source: PPUTMP Project Team

Figure 1.2-3 About the Parking Regulation

(2) Pedestrians

Many interviewees answered positively such as more smooth walking and increase of safety.

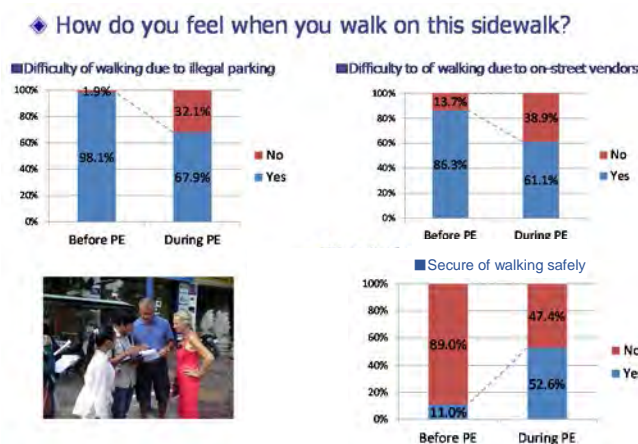

Source: PPUTMP Project Team

Figure 1.2-4 Impression about the Sidewalk

(3) Drivers

More than 70% of drivers felt that the one-way system should be continued.

◆ About one-way traffic system

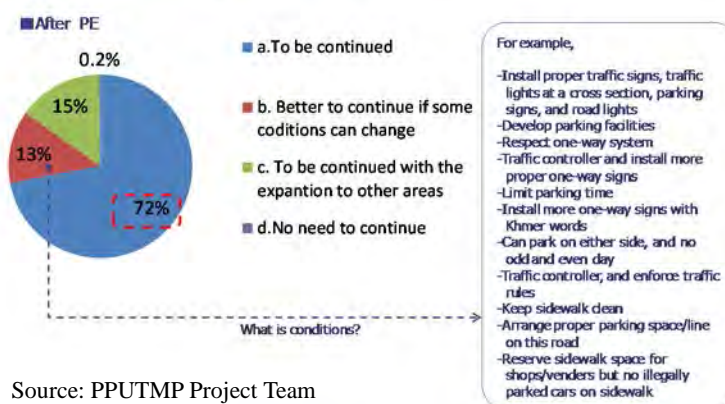

Source: PPUTMP Project Team

Figure 1.2-5 About One-way System

1.2.4 Results of Vehicle Parking Survey

The survey showed that along the 8 metre wide road sections with a single side parking strip, the number of parked vehicles during peak hour was higher than the actual capacity. This showed that vehicles were still being parked on both sides of the road sections or on the sidewalks.

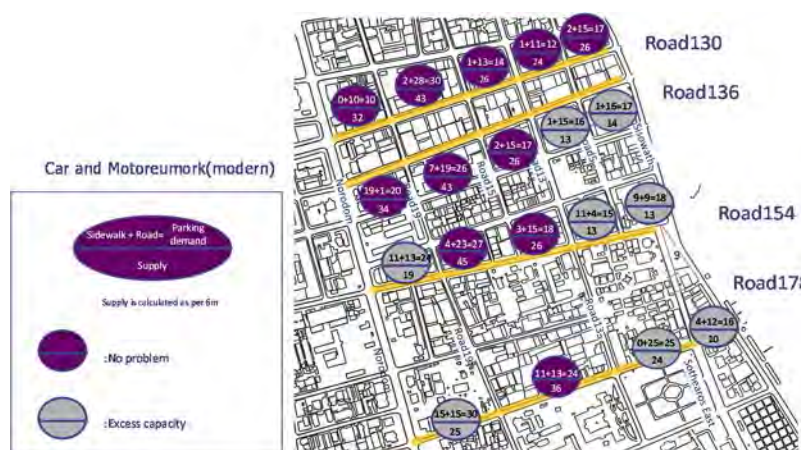

Source: PPUTMP Project Team

Figure 1.2-6 Results of Parking Survey (Passenger car and motoreumok modern (tuk-tuk))

1.3 Summary

1.3.1 One-way System

Public experiment of one-way system was conducted for the smooth traffic flow in the local roads.

Traffic volume of 1.5times than before was observed along St.154 because of increase of road capacity by one-way system.

More than 70% of drivers answered that the one-way system should be continued.

On the other hand, 20% of total traffic was opposite direction and 80% of this was motorcycles.

It is necessary to disseminate information about the one-way system to drivers, in cooperation with local residents and traffic police, for a period of time and in a consistent manner.

The expansion of one-way system to the other local roads in the city centre is necessary.

1.3.2 Parking Regulation

Measures of on-road parking arrangement were conducted for the purpose of appropriate parking arrangement and securing the pedestrian space.

Many on-sidewalk parked cars moved to arrange on-road and off-road parking space in collaboration with roadside residents.

More than 70% of roadside residents answered that it is necessary to continue this parking arrangement. Sections with demand exceeds capacity sections can be observed especially at narrow sections (w=8m). It is necessary to develop comprehensive parking measures to cope with the anticipated increase in parking demand in the future.

1.3.3 Pedestrian Space

Continuous sidewalk network (w=2.0m) can be secured for the creation of safe and comfortable pedestrian spaces for roadside residents and tourists.

Many interviewees answered that walking on the street has become more safer than before because of the removal of illegally parked cars and vendors.

It is expected that, as an offshoot of this public experiment, the city will realize the need to develop safe and comfortable pedestrian spaces for foreign tourists and introduce public transport, if the city is to join the ranks of international tourist destinations.

1.4 Recommendations

Most of road users including roadside residents accept these countermeasures.

How to effectively use local road space is the key to solving traffic problems especially in the busy city center.

Local road space is required to cater not only to vehicular traffic and pedestrians but also to parking needs.

These measures of public experiment including one-way system, parking and sidewalk arrangement are effective and acceptable to the public. Therefore, expansion of these measures to other areas based on carefully conducted surveys is essential for a better urban environment.

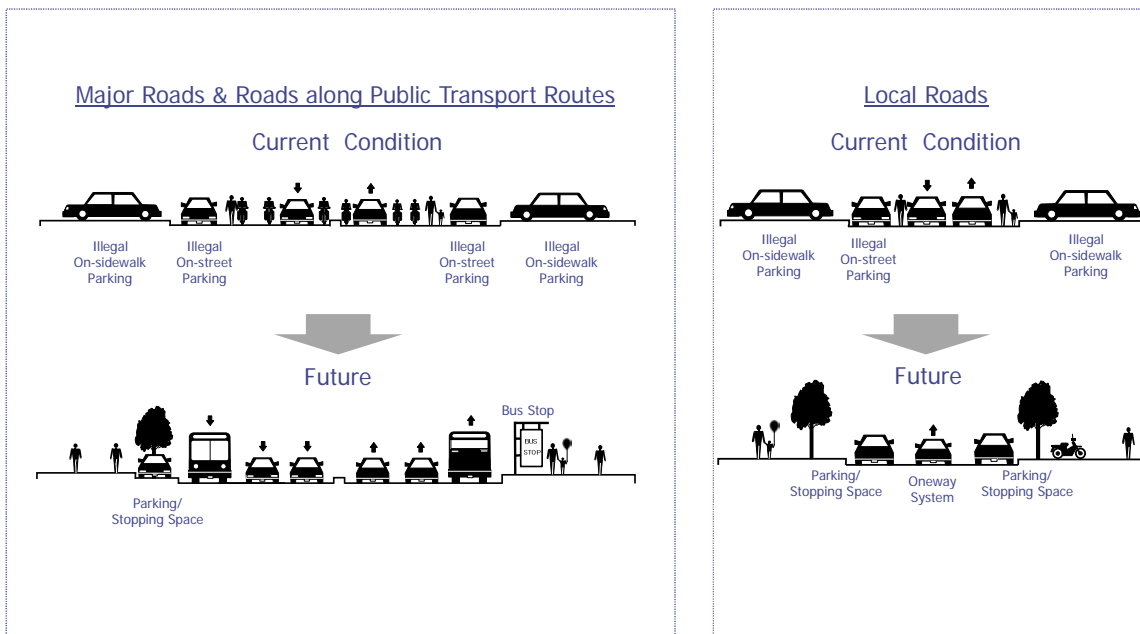

Source: PPUTMP Project Team

Figure 1.4-1 Road Space Usage

2. 2ND PUBLIC EXPERIMENT

2.1 Public Experiment on Bus Operation

2.1.1 Objective

Traffic congestion in Phnom Penh is deteriorating by the day and a solution is needed to resolve this serious urban transport problem. The introduction of a public transport mode that is capable of moving a large volume of travelers at one time is the most promising way to solve this problem.

This Public Experiment is aimed at assessing the possibility of any major impacts on the society when a new transport measure may be introduced in the near future. Hence this Experiment is carried out to test out the new transport measures over a specific time and at a location to gauge the actual impacts of these measures on the public.

The introduction of a new public transport mode to a city is likely to bring about major impacts on the society. Hence a bus operation experiment is proposed and implemented to enhance the acceptance and concerns of the general public on a new public transport system. The main objective of this Public Experiment is therefore to introduce a bus service as the first step in preparing the public of Phnom Penh in accepting a major transformation of the city's public transportation system.

2.2.2 Coverage Area for the Public Experiment

(1) Bus operation

The bus route for the Public Experiment shall be the section from in front of the Old Stadium (Chruoychangvar Roundabout) along Monivong Blvd. and beyond to Chabar Ampov Terminal, a distance of about 7 km.

(2) Systematized Traffic Signal Control and Bus Priority Signal Control Experiment

The three intersections (Monivong Blvd./Russian Blvd., Monivong Blvd./Kampuchea Krom Blvd. and Monivong Blvd./Charles de Gaulle Blvd. are targeted for this experiment.

The above three intersections are situated in the city center. There is no significant difference in the high traffic volume in both directions during both the morning and evening peak hours. Therefore they are ideal to try out the simultaneous offset system of control.

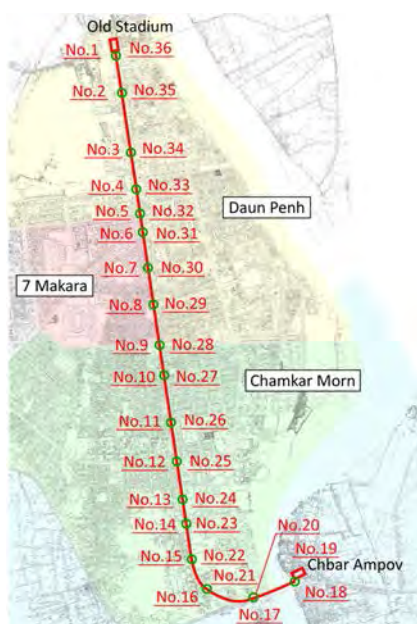

Source: PPUTMP Project Team

Figure 2.1-1 Bus Route



Source: PPUTMP Project Team

Figure 2.1-2 Three Target Intersections along Monivong

2.2 Results of the Experiment

2.2.1 Bus Usage Situation

Total Number of Bus Passenger	The total cumulative number of bus passenger over the entire Experiment period from 5th February to 4th March was 43,278 persons.
Average Daily Number of Bus Passenger	The average daily number of bus passenger was 1,546 persons/day. Assuming 1 person/vehicle, there was therefore a reduction of daily traffic volume by about 1,500 vehicles.

2.2.2 Total Alighting and Boarding Bus Passengers at Bus Stops

High numbers of alighting or boarding passengers were recorded at both ends of the terminal stops. Many residents from the suburbs used Motordop to get to the terminal stops and then transfer to the bus to get to their destinations in the city center.

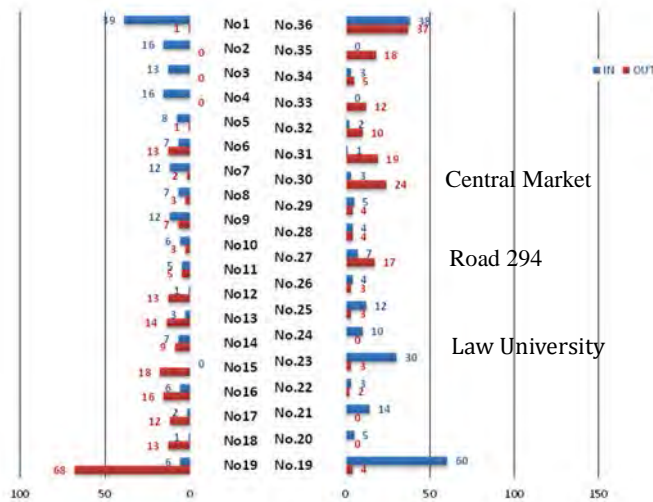

Source: PPUTMP Project Team

Figure 2.2-1 Number of Alighting and Boarding Bus Passengers by Bus Stop

2.2.3 Travel Time Survey (Effects from systematization of traffic control signals at 3 intersections in the city center)

In comparing the travel times before and after the traffic control signals at the 3 intersections were systematized, there were savings of about 1.3 minutes for southbound traffic and 1.1 minutes for northbound traffic during the morning peak hours. On the other hand, there were savings of 1.3 minutes for southbound traffic and 0.6 minutes for north bound traffic in the evening peak hours.

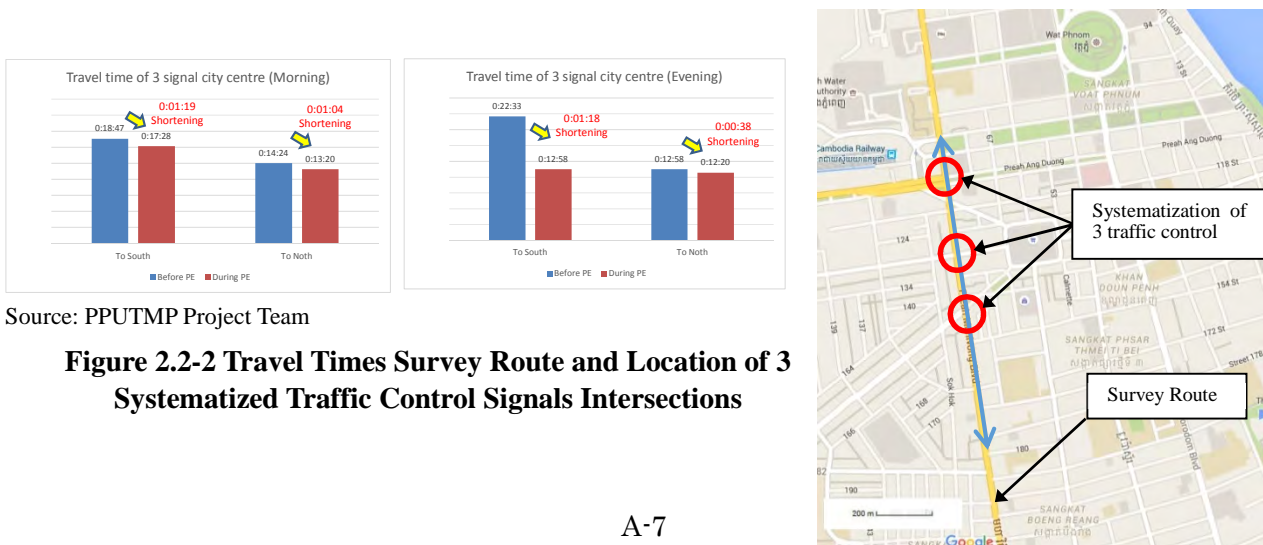

Source: PPUTMP Project Team

Figure 2.2-2 Travel Times Survey Route and Location of 3 Systematized Traffic Control Signals Intersections

2.2.4 Interview Surveys

(1) Distance from Your Place to the Bus stop

41.2% stated they lived within ‘0-100m’ followed by 101-200m at 15.7%. There was as many as 30% who lived more than 401 m away from the nearest bus stop. From these results, more than half of the respondents lived up to 200 m away from the bus stop. This is the distance between bus stops in the urban areas in this Public Experiment. Hence, a bus stop interval of 300 m is considered most appropriate. Suburban users living beyond the terminals transferred to the bus as its fare is cheaper than Motordop. This showed that extension of the bus route to the suburbs will be effective.

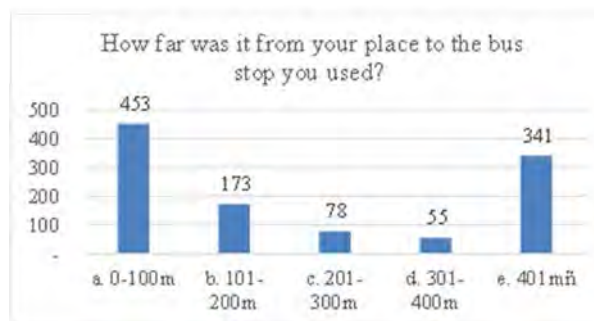

Source: PPUTMP Project Team

Figure 2.2-3 Distance from Your Place to the Bus Stop

(2) Acceptable Bus Fare

A fare of ‘1500 riels’ has the support of most respondents with 73.1%. This was followed by 20.3% who thought ‘1000 riels’ was more acceptable. The results showed that a bus fare of up to 1500 riels (equivalent to Japanese Yen 40) was the most acceptable level. This fare level as set in this Public Experiment was well accepted by the local residents.

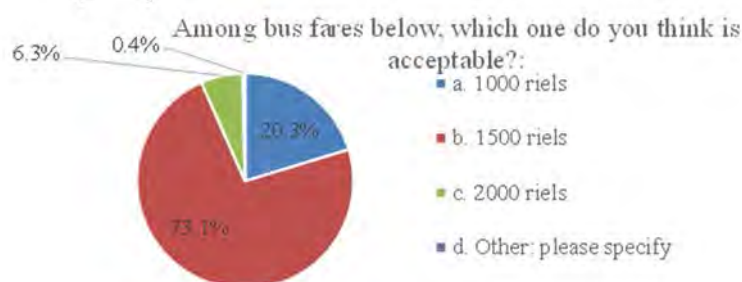

Source: PPUTMP Project Team

Figure 2.2-4 Acceptable Level of Bus Fare

2.2.5 Most important feature of Public Transport in Future to Citizens

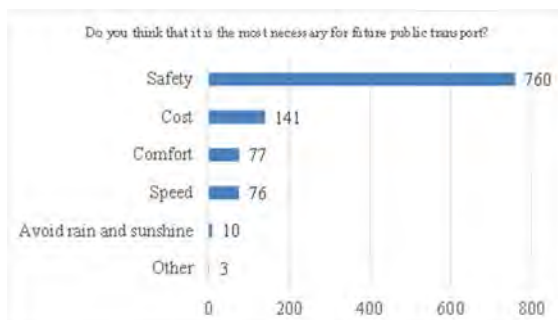

Source: PPUTMP Project Team

‘Safety’ emerged as the most important feature given by the respondents (71.2%). This reflected the desire of the residents to have a safer transport mode compared to motorbike which is the current most prevalent mode of transport. This was followed by ‘cost’ at 13.2%. This reflected the concern for public transport that is affordable to low income groups and students.

Figure 2.2-5 Most Important Feature of Public Transport in Future to Citizens

2.2.6 Opinions of Residents if Bus stops are to be installed near their Homes

62.1% of the residents interviewed felt it would be ‘good’ and another 10.5% felt it would be ‘very good’. Hence more than 70% of the residents interviewed showed favorable responses to such a proposal.

Figure 2.2-6 Opinions of Residents if Bus Stops being Installed Near Their Homes

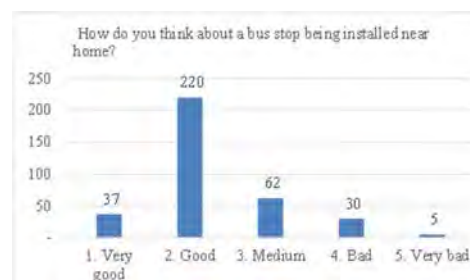

Source: PPUTMP Project Team

2.2.7 Responses from the Mass Media

◇ Responses from Local and International Media

Besides local Phnom Penh newspaper and television channels, international news media such as New York Times and Australian News have also reported on the introduction of the new bus system in Phnom Penh.

◇ Comments from Local Residents

Residents have indicated their approval for the bus service with some saying ‘my makeup would messed up while riding the motorbike, but with bus it is alright!’ or ‘I can do some study sitting in the bus’. On the other hand, some comments about the bus stops being dark and dangerous at night were noted and efforts to improve them will be taken in future.

Figure 2.2-7 Front Page News Report on the Phnom Penh Post



Source: PPUTMP Project Team

◇ Users’ voices on Facebook

- The bus to be operated should be standard with full facilities like those in other countries, especially Cambodia’s neighbors, even though it is a trial run.
- Busway maintenance should be conducted, and parking regulations must be strictly enforced by the traffic police department, because nowadays bus route is interrupted by illegally parked vehicles causing long waiting time for passengers.
- Bus poles are too small and not even reflective, and there are no waiting sheds for passengers to use during night time. Thus, passengers do not feel safe while waiting for the bus.



Source: PPUTMP Project Team

Figure 2.2-8 Facebook of Public Experiment

2.3 The Future of Public Transport

2.3.1 How to Maintain the City Bus Operation

With the experience gained from the Public Experiment, the following 3 alternative cases of possible continuation on the operation of the public bus service by the city were set up for a comparative analysis.

Case 1: Bus service to continue with exactly the same conditions as in the Public Experiment

Case 2: Bus coaches to be supplied by the City (bus depreciation cost excluded)

Case 3: Bus coaches to be supplied by the City (bus depreciation cost included)

Table 2.3-1 Estimation of Operation Costs

	Operation Cost (USD/Month)	Monthly Passenger Volume (Person)	Travel cost per person (USD)	Operation Cost (USD/Month)	Monthly Deficit (USD)
	①	②	③=①/②	⑤=③-④	⑥=⑤*②
Case 1: Bus service to continue with the same conditions as in the Public Experiment	47,460	43,278	1.10	0.72	31,300
Case 2: Bus coaches to be supplied by the City (bus depreciation cost excluded)	24,550	43,278	0.57	0.19	8,400
Case 3: Bus coaches to be supplied by the City (bus depreciation cost included)	33,350	43,278	0.77	0.40	17,200

※Bus Fare/passenger=1,500 Riel=0.375 USD・・・④

Source: PPUTMP Project Team

2.3.2 Profile of the Bus Users

The profile and its change of bus passengers is analyzed based on the various surveys in this experiment and the comparison between this public experiment and that conducted in 2001.

Table 2.3-2 Profile of the Bus Users

	Public Experiment in 2001	Public Experiment in 2014
Passenger Characteristics	Workers + Students (mainly high school) 20%+ 50%	Workers + Students (University, college and vocational) 44%+ 30% ※50% of 20 to 29 age group is students
Bus route	2 routes (Monivong and Sihanouk/Norodom) • Many high schools locate along Norodom Blvd.	1 route (Monivong) • Universities, colleges, hospital and business district along Monivong Blvd. • Many transfer passengers to/from Motodop at terminals.
Operational interval	6 to 10 minutes	10 to 15 minutes
Number of passengers	50,790 passengers/month (Monivong route) 1,693 passengers/day (Monivong route) • There were transfer passengers between two routes.	46,380 passengers/month 1,546 passengers/day • Number of weekend passengers dropped latter half of the experiment period
Bus fare	800Riel	1500Riel (2014/2001 = 1.9 times)
(Minimum charge of motodop)	500Riel	2000Riel (2014/2001 = 4.0 times)
Household income from Person trip survey	322USD/month	464USD/month (2014/2001 = 1.4 times)
How people know about bus service	TV spots (54% out of total)	TV spots (49% out of total) (It can be observed that bus operation information was shared through Facebook among young workers and students.)

Source: PPUTMP Project Team

2.3.3 How to Cover the Operating Deficit of the Bus Operation

The key to the sustainable bus operation is how to cover the operating deficit of the bus operation. Based on the data and survey analysis of the experiment and others, the following suggestions are made:

- ◆ Increasing bus passengers
 - Introduce seasonal tickets to workers and students (many requests from bus users)
 - Expand and increase bus routes
 - Improve transfer system at terminals
 - Make boarding/alighting of passengers smooth and convenient by introducing two-door bus fleet
 - Take measures to ensure that bus services on weekends and holidays match the demand
 - Promote by effective use of TV spots and SMS
- ◆ Increasing income but without increasing bus fare
 - Accept advertisements on the bus body (rapping bus)
 - Accept advertisements for bus stop poles, bus shelters and bus terminals
 - Work out terminal development rights with bus operator, etc.
- ◆ Increasing bus fare
 - Bus fare alone cannot cover the bus operational cost; the increase of bus fare is just one of the measures. However, the increase of bus fare without any service improvement to benefit the bus users will result in decrease of bus passengers. With bus routes expansion and increase of routes, there will be an increase in convenience for bus users, which may make them more accepting of a fare increase.

2.3.4 How to Sustainably Continue the City Bus Operation by DPWT Themselves

How to improve the bus operation is an important matter based on the passengers' voice if DPWT operates city buses by themselves. Following are the countermeasures of improvement of bus operation based on the hints from the passengers' comments during the public experiment.

◆ Introduce bus season tickets

Many passengers request the introduction of season tickets because majority of them are workers and students who are using the bus every morning and evening going to and from work/school. Generally, almost all cities in the world offer season tickets to attract more passengers and to improve the affordability of bus fares.

◆ Introduce the two-door bus

A fleet of one-door buses was used during the public experiment, because only one-door buses are available in Phnom Penh. But the one-door bus needs more time during loading/unloading of passengers at bus stops. For the convenience of passengers, it is necessary to introduce the two-door bus, which is commonly used for the city bus operation in other countries.

◆ Improve the night time safety at bus stops

Many working students are expected to use the bus after school at night, based on the result of the public experiment. To secure the night time safety at bus stops, the bus stops should be well-lighted.

◆ Improve the safety circumstances during bus operation

Bus operation safety especially during loading/unloading of passengers is the biggest concern of passengers. Since bus operation safety is one of the most important aspects of city bus operation, measures should be put in place to ensure safety. This will give a boost to the continuous safety education of drivers/conductors and the establishment of the bus operation/management system in DPWT.

2.3.5 Current Situation of the City Bus Operation

On the day following the end of the Public Experiment, the City of Phnom Penh commissioned a private enterprise called Global Company to continue operating the same bus service on the same route with the same fare for another month, that is, from 5th March to 4th April in 2014.

By June 2014, PPCH has extended the current bus service towards the north and south directions.

In September 2014, the Public Transport Management Authority (PTMA) was established to operate and manage the city bus in collaboration with PPCH and DPWT. With the establishment of PTMA, the number of bus routes has been increased from one (1) to three (3) routes plying not only the north and south but also the west and east covering major transport corridors in PPCC. Forty-three (43) second-hand buses from Korea were operated and 6,930 (average of 1 - 15 December 2014) daily passengers are served. PTMA plans to expand bus service to cover 10 routes with bus fleet of 200 in 2020.

3. PRE-FEASIBILITY STUDY

3.1 Demand Forecast of Target Transit System

(1) General

Demand forecast for preliminary feasibility study was conducted according to the following framework.

- Target year for demand forecast is set at 2035 (long term) and 2020 (medium term).
- The input data for demand estimation are based on the future trip OD matrix data and time table between zones which was estimated in the road traffic simulation analysis.
- The output items consists of peak hour sectional transport volume for operation planning, total number of passengers per day for revenue estimation and boarding & alighting passengers by station and trip matrix between stations.
- Taking into consideration of corridor characteristics that there are several traffic nodes existing along the corridor, passengers related to airport travelers and passengers related to long distance bus are included in passengers number in addition to ordinary corridor base passengers.

(2) Estimation of Corridor base passengers

- Based on the person trip OD database in 2035 which was estimated in the transport master plan, corridor base passengers number was estimated according to the flow-chart shown in Figure 3.1-1.
- Diversion trips to transit system is estimated, applying logit type diversion curve of which explanation variables is the time difference of time required between zones, depending on with/without transit.
- As for the presumption of calculating time required by transit use, 30km/h is assumed as the commercial speed of system, and 3 minutes/ 5 minutes are assumed as average waiting time of transit service and mode change transfer time respectively.

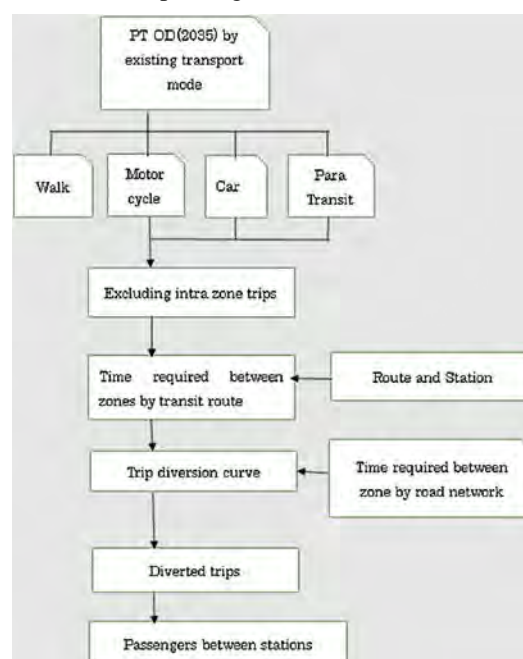

Source: PPUTMP Project Team

Figure 3.1-1 Flow-chart of Estimating Corridor Base Passengers

(3) Estimation of passengers related to airport travelers

Transit system passengers related to international/domestic travelers, departing/arriving at Phnom Penh airport are estimated.

Future annual base airport travelers in target year was estimated, assuming average growth rate of travelers, based on the latest trend data on airport travelers in Phnom Penh airport. Annual passengers number was converted to daily passengers number, taking into account of monthly peak variation during a year. In addition, accompanying passengers with airport travelers such as well-wishers are also included.

Regarding the modal choice rate of transit system, existing modal choice rate for transport means other than private transport was applied based on the result of airport passengers interview survey which was conducted in PPUTMP.

(4) Future Transit Passengers

Table 3.1-1 and 3.1-2 shows daily passengers trip matrix between stations and section passenger volume between stations (station location is indicated in Figure 3.1-2).

The total number of passengers in 2035 is estimated around 82,000 and maximum section volume in peak hour /direction is 6,000 PPHPD (as for medium term, 2020, total number of passengers: around 68,000 and peak hour volume: 5,000, respectively.).

Table 3.1-1 Trip Matrix between Stations in 2035

unit: pax/day

Station	1	2	3	4	5	6	7	8	9	10	11	12	13	Total
1	0	10,012	3,163	544	552	1,551	175	4	9	5,648	22	452	97	22,228
2	6,333	0	4,911	299	311	814	154	4	16	5,026	7	418	24	18,317
3	3,407	4,886	0	2,199	321	1,012	108	3	2	183	12	395	12	12,540
4	887	448	1,027	0	264	379	15	0	0	23	1	7	1	3,052
5	659	266	428	281	0	276	8	0	0	18	0	0	1	1,937
6	1,671	709	1,206	504	293	0	358	3	1	454	2	16	5	5,221
7	55	41	23	15	0	8	0	413	410	1	0	0	0	967
8	122	83	103	33	7	242	414	0	414	246	6	16	1	1,688
9	10	8	14	1	0	1	410	414	0	13	1	1	0	874
10	5,008	4,207	318	62	6	468	0	241	16	0	415	447	30	11,218
11	31	9	15	3	0	2	0	2	0	404		430	36	940
12	343	255	293	18	0	14	0	16	1	442	453	0	275	2,110
13	114	21	23	3	0	6	0	1	0	32	0	335	0	534
Total	18,639	20,945	11,524	3,961	1,755	4,774	1,641	1,101	871	12,489	927	2,519	481	81,626

Source: PPUTMP Project Team

Table 3.1-2 Sectional Passenger Volume between Stations

Unit: pax/day (upper row), pax/hour (lower row)

Stations	1	2	2	3	3	4	4	5	5	6	6	7	7	8	8	9	9	10	10	11	11	12	12	13	
Day →	22,228	24,200	20,373	18,021	16,877	13,683	13,690	13,948	13,110	2,392	2,391	481													
Day ←	18,639	23,239	18,396	16,954	15,627	11,985	12,667	12,337	11,496	2,049	2,035	534													
Peak 1 hour →	5,557	6,050	5,093	4,505	4,219	3,421	3,423	3,487	3,277	598	598	120													
Peak 1 hour ←	4,660	5,810	4,599	4,238	3,907	2,996	3,167	3,084	2,874	512	509	133													

Source: PPUTMP Project Team

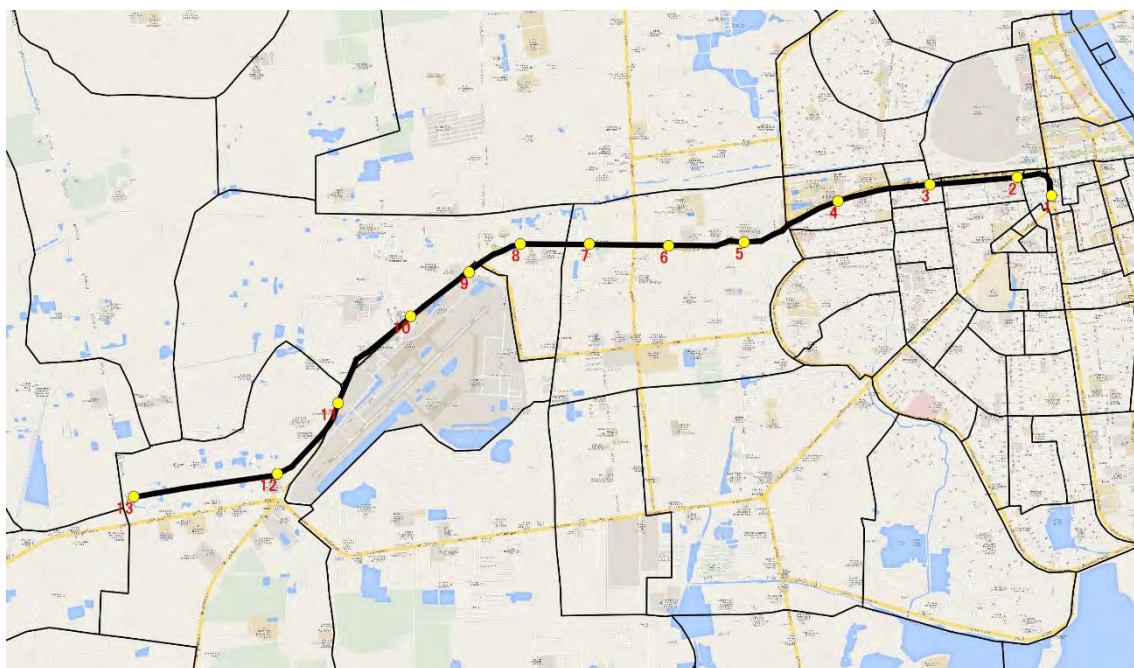

Source: PPUTMP Project Team

Figure -3.1-2 Location of Each Station

3.2 Proposed Rail Transit System

Based on the passenger demand and urban characteristics in Phnom Penh, rail transit system alternatives were selected from the medium capacity rail transit system found in many parts of the world. These are (1) Linear Metro, (2) Monorail, (3) Automatic Guided Transit (AGT), (4) Light Rail Transit (LRT) and (5) Tramway.

The comparison of main specifications of the above five rail transit system alternatives is shown in Table 3.2-1.

To select rail transit system subject to preliminary feasibility study, evaluation was made based on following criteria. The result is summarized in Table 3.2-2. In this table, a system that satisfies a criterion has ○ mark; and a system that does not satisfy a criterion has Δ mark. The system with the largest number of ○ mark is the most suitable system to be introduced into Phnom Penh.

- i. Passenger Capacity
- ii. Contribution to Urban Development
- iii. Contribution to Urban Scenery
- iv. Future Expansion of the System
- v. Impact to Road Traffic
- vi. Flexibility of Geometric Design (minimum curvature, maximum longitudinal slope and tunnel)
- vii. Operational Reliability (Maintain a stable operation speed)
- viii. Countermeasures for Heavy Rain and Emergency
- ix. Passenger Comfort (Transfer)
- x. Consideration for the Urban Environment (noise, vibration and air pollution)
- xi. Preliminary Cost including Infrastructure
- xii. Operational Cost (maintenance and reduced labor cost)
- xiii. Easiness of Procurement
- xiv. Specific Advantage of the Japanese Technology

Through the above evaluations, it is found that AGT is the optimum rail transit system for the East-West transport corridor. AGT is the most flexible system in terms of geometric design among the alternatives, it is environmentally friendly and has advantages of Japanese innovative technologies.





Table 3.2-1 Outline and Specifications of Candidate Public Transport System

Comparison of Specifications Between Major Urban Railway Transport			Linear Metro	Monorail	AGT	LRT	Tramway	
System			Green Line/Yokohama	Yui-Rail/Okinawa	Sengkang/Punggol Line/Singapore	Line 1/Manila	Hiroshima Electric Railway	
Route Name								
Vehicle Type			1000 Series	1000 Series	Cristal Mover	3rd Generation	5100 Series (Green Mover Max)	
Train Overview								
Tire/Wheel			Steel Wheel (Linear Motor)	Rubber Tire	Rubber Tire	Steel Wheel	Steel Wheel	
Bogie Structure			2 Bogies(4 Axles)	2 Bogies(4 Axles)	2 Axles(no Bogie)	3 Bogies(6 Axles)	3 Bogies(6 Axles)	
Car Body Structure			1 Body/1 Car	1 Body/1 Car	1 Body/1 Car	2 Bodies/1 Car (1-Articulated)	5 Bodies/1 Car (4-Articulated)	
Dimension (mm)	Length		15,500	14,700	11,200	28,500	30,000	
	Width		2,490	2,980	2,690	2,590	2,450	
	Height		3,105	5,100	3,615	3,910	3,645	
Alignment Criteria *1	Minimum Curve Radius (m)		180 (100)	100 (50)	100 (30)	160 (100)	11	
	Maximum Gradient (%)		60	60 (100)	60 (100)	35	40	
Electric System			DC 1500V	DC 1500V	DC 750V	DC 750V	DC 600V	
Power (kW)	per One Motor		135	100	80	105	100	
	Total Freet Power		1,080	600	160	630	400	
Vehicle Performance	Max. Operation Speed (km/h)		80	65	70	60	70	
	Acceleration (km/h/s)		3.2	3.5	3.6	4.0	3.5	
	Normal Deceleration (km/h/s)		3.5	4.0	3.8	4.7	4.8	
Car Capacity (persons/car)	Normal Ride (3.3persons/m2)		95	82	79	199	149	
	Peak Hour Ride (5persons/m2)		126	107	109	265	196	
Train Configuration			(cars/train)	4	2	1	4	1
Capacity (Actual Result)			(trains/hour/1 direction)	16	11	17	20	13
Max. Capacity			(PHPDT)	8,064	2,354	1,853	21,280	2,548
Train Configuration			(cars/train)	6	6	6	4	1
Train Frequency			(trains/hour/1 direction)	30	30	30	30	30
Capacity			(PHPDT)	22,680	19,260	19,620	31,920	5,880
Weight (t)	Tare Weight of Motor Car		26.0	26.3	14.9	36.5	33.9	
	Passenger Weight	Normal	5.7	4.9	4.7	11.9	8.9	
		Peak Hour	7.6	6.4	6.5	16.0	11.8	
	Total (Tare+Passenger)		31.7	31.2	19.6	48.4	42.8	
	Peak Hour		33.6	32.7	21.4	52.5	45.7	
Axle Load (t)	with Maximum Passengers		9.8	9.3	12.9	10.7	7.5	
Car Weight per Passengers(Normal)	(t/person)		0.33	0.38	0.25	0.24	0.29	
Line Length	(km)		13.1	12.9	20.2	20.0	21.5	
Unit Cost of Construction	Total	(Million USD/km)	184	86	(N.A)	App. 50	(N.A)	
	Rolling Stock	(Million USD/car)	1.3	2.5	1.8	App. 2	3.2	
	Precondition		Actual result of Yokohama Major part is underground (Underground 10.7km, Surface 2.4km)	Actual result of Okinawa Monorail	Actual result in Japan About 55~140Million USD/km Rolling Stock price is Macau's example	Assumed value of Manila Line ¹	Actual result of Hiroshima Electric Railway	

(Note) Figures of each system include assumed value by calculation. Therefore, some values may be different from the manufacturer's announcement.

*1: According to Japanese railway criteria / () unavoidable case

Table 3.2-2 Evaluation of the Rail Transit System Alternatives

Item	Linear Metro	Monorail	AGT	LRT	Tramway
					
1 Passenger capacity	Applicable	Applicable	Applicable	Applicable	Partially applicable
2 Contribution to urban development	Possible	Possible	Possible	Possible	Possible
3 Contribution to urban environment (urban scenery)	Possible	Possible	Possible	Possible	Possible
4 Applicability to the staging (flexibility for future expansion)	Possible	Possible	Possible	Possible	A little difficult
5 Impact to vehicular traffic	None	None	None	None	Yes
6 Flexibility to geometric design	Difficult for small radius of curvature but possible for steep gradient	Possible for small radius of curvature and steep gradient	Possible for small radius of curvature and steep gradient	Difficult for small radius of curvature and steep gradient	Difficult for small radius of curvature and steep gradient
7 Operational reliability (operational speed and travel time)	High reliability because of exclusive right of way	High reliability because of exclusive right of way	High reliability because of exclusive right of way	High reliability because of exclusive right of way	Mixed with vehicular traffic
8 Countermeasures for heavy rain and emergency	Possible	Difficult to secure	Possible	Possible	Affected by flood
9 Passenger comfort (transfer)	Different levels during transfer between other modes	Different levels during transfer between other modes	Different levels during transfer between other modes	Different levels during transfer between other modes	Same level during transfer
10 Urban environment (noise, vibration and air pollution)	Steel wheel	Quiet because of rubber tire	Quiet because of rubber tire	Steel wheel	Steel wheel
11 System cost	USD160 mil./km - USD310 mil./km	USD90 mil./km - USD150 mil./km	USD50 mil./km - USD130 mil./km	Manila LRT No. 1 USD50 mil./km	Systra Study USD20 mil./km
12 Running cost (maintenance and work savings)	Relatively high	Relatively high	Relatively high	Relatively high	Relatively low
13 Ease of procurement	Limited development	Limited development	Limited development	Globally popular	Globally popular
14 Advantages of Japanese technology	Has technical advantages because it is much developed and widely used in Japan	Has technical advantages because it is much developed and widely used in Japan	Has technical advantages because it is much developed and widely used in Japan	Few development examples in Japan	Few development examples in Japan
Overall Evaluation	Applicable in Phnom Penh but more effort needed to develop as the elevated system	Applicable in Phnom Penh	Highly applicable in Phnom Penh	Applicable in Phnom Penh	Some corridors can be used

Source: PPUTMP Project Team

3.3 Most Suitable Railway System Route and Selection of Depot Location

(1) Basic Idea for Planning Railway System Route and Selection of Depot Location

1) Design Standard

Design standard for AGT is shown on Table 3.3-1 which is the basis of most suitable railway system route planning and selection of depot location.

Table 3.3-1 Design Standard for AGT Planning

Item	Standard	Remark
Gauge	1,850 mm	
Distance between centre of tracks	4,000 mm	
Minimum curve radius, for both main line and depot	100 m	Unavoidable case: 30 m
Maximum gradient	60/1000	
Minimum Vertical curve radius	1,000 m	
Turnout dimension	Attached figures	
Maximum operating speed	70 km/h	
Operation system	UTO (Unattended Train Operation) is able to be applied. Operation system is decided by responsible proprietor.	
Location for Centralized traffic control	OCC (Operation Control Centre)	
Electric power system	Direct current 750V	
Electric current collection system	Third rail	

Source: PPUTMP Project Team

2) Most Suitable Railway System Route Planning

Basic idea for the most suitable railway system planning is as follows.

- To select the location of each station, the intervals between stations shall be well-balanced and convenient for passengers.
- To decrease the bad influence to the automobile smooth traffic.
- To decrease the purchasing of private estate by making use of public land as road, etc.
- To decrease construction cost and future maintenance and management cost.
- To shorten the length of tunnel section, the cost of which is comparatively larger than viaduct section, as short as possible.
- To reserve ride quality, and to decrease maintenance cost, too small curvature is to be avoided except the unavoidable case.
- To decrease the Negative effect on environment.

3) Selection of Depot Location

Basic idea to select suitable depot location is as follows.

- The depot area is to be more than 7 or 8 ha for the stabling of rolling stocks, maintenance facilities, etc. for the present planning and future expansion.
- The depot location is to be selected near the operational line and is to be easy for trains to enter into and depart from the depot.
- To make the land acquisition as smoothly as possible, the depot area is to be selected to the place where it is not being used for some definite purpose and houses are few.

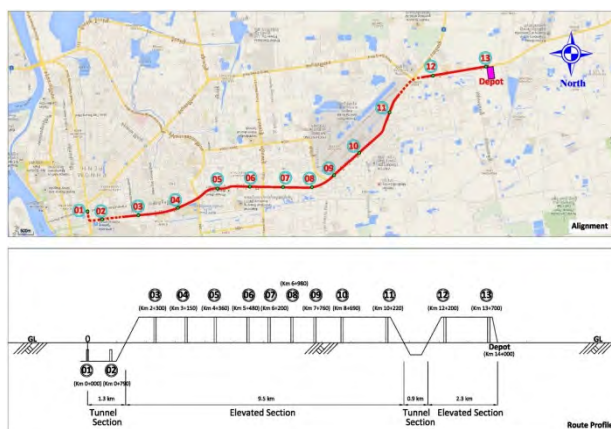

Source: PPUTMP Project Team

Figure 3.3-1 Outline of Alignment and Route Profile

(2) Railway System Route Planning of Each Section

Railway system route planning of each section is being carried out based on the basic idea of the above. Outline of planned line alignment and longitudinal cross section is shown on Figure 3.3-1.

3.4 System Operation Plan

(1) Main Specifications of Rolling Stock and System

1) Proposed Introducing System

AGT (Automated Guideway Transit) system is proposed to introduce to Phnom Penh East-West Line. An example image of AGT train configuration is shown in Figure 3.4-1. The dimensions of one vehicle are 11.2m long (11.8m including coupler), 2.7m wide and 3.7m high. Total train length of 3 cars is 35.3m.

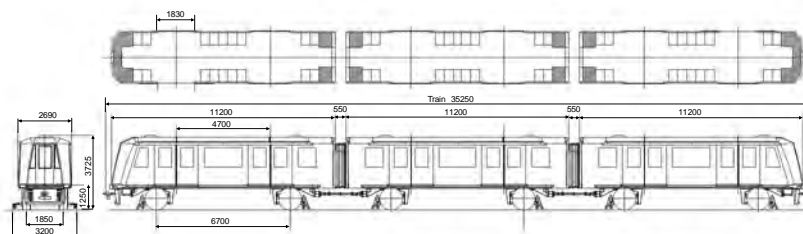

Source : PPUTMP Project Team based on the example of Singapore

Figure 3.4-1 Image of Vehicle

2) Main Specifications of AGT

Main specifications of this line and AGT are shown in Table 3.4-1. The operation length is 13.7 km, the number of stations is 13, and the train capacity of a 3-car train is 331 persons. Concerning train running performance, maximum operation speed is 70 km/h, acceleration and normal deceleration are both 3.6 km/h/s. The estimated commercial speed is 35 km/h and the required train running time per one way is planned to be approximately 24 minutes.

Table 3.4– 1 Main Specifications of AGT

Item		Content / Value	
Route	Operation Length	13.7 m	
	Number of Stations	13 Stations	
	Alignment Criteria *1	Minimum Curve Radius	100 m (30 m)
		Maximum Gradient	60 ‰ (100 ‰)
Vehicle	Type of System	AGT (Automated Guideway Transit) with Rubber Tires	
	Vehicle Dimension (L×W×H) *2	11,200 mm × 2,690 mm × 3,615 mm	
	Tare Weight of 1 Vehicle	Approximate 18 t	
	Electric System	DC 750V	
	Power Collection Method	Third Rail System	
	Train Configuration	3 cars/train (4 cars/train possible in Future)	
	Train Capacity	Peak Hour Ride (5persons/m2)	331 persons/train (3 cars/train)
Train Operation	Vehicle Performance	Max. Operation Speed	70 km/h
		Acceleration Normal Deceleration	3.6 km/h/s / 3.6 km/h/s
	Estimated Commercial Speed	35 km/h	
	Required Train Running Time per One Way (Include Dwell Time at Stations)	Approximate 24 min	

(Note) *1 : According to Japanese railway criteria / () unavoidable case

*2: Value of Singapore Type Vehicle

Source : PPUTMP Project Team

(2) Examination of Train Operation Plan and the Number of Train-sets/Vehicles

The required train operation trips at peak one hour are calculated by dividing the maximum passenger load at peak one hour (for two cases of 5,000 passengers in 2020 and 6,200 passengers in 2035) by one train capacity (331 persons of 3-car train). The calculated train operation trips at peak one hour i11 trains in 2020 (3.8 min. headway) and 19 trains in 2035 (3.2 min. headway) as shown in Table 3.4-2.

The required number of train-sets/vehicles is calculated from the round-trip time at the peak hour. First, the round-trip time is calculated by doubling the time including one way operation time (24 min) and a

turn back time (set to 5 min). The required number of train-sets is computed of the required number of train-sets for operation added the number of train-sets for spare (spare rate is set to 10%). The required number of train-sets/vehicles is 18train-sets/54cars in 2020 and 21train-sets/63cars in 2035 as shown in Table 3.4-2.

Table 3.4– 2 Train Operation Plan at Peak Hours and Calculation of Required Number of Train-sets/Vehicles

Item		Unit	Formula	2020	2035	Remarks
Train Operation Plan	Peak Demand per Hour	persons/hour · direction	a	5,000	6,200	between St2 to St3
	Train Capacity	persons/train	b	331	331	5persons/m2
	Required Train Operation Trips	trains/hour · direction	c=a/b	16	19	
	Operation Headway	min	d=60/c	3.75	3.16	
Calculation of Required Number of Train-sets /Vehicles	Operation Time	min	f	24	24	Commercial Speed 35km/h
	Turn Back Time	min	g	5	5	
	Roundtrip Time	min	h=(f+g)*2	58	58	
	Required No. of Train-sets for Operation	train-sets	j=h/d	16	19	
	No. of Train-sets for Spare	train-sets	k=j*10%	2	2	Spare Rate 10%
	Total No. of Train-sets	train-sets	m=j+k	18	21	
	Train Configuration	cars/train-set	n	3	3	
	Total No. of Vehicles	cars	p=m*n	54	63	

Source : PPUTMP Project Team

3.5 Preliminary Facility Plan

(1) Civil Work Facility Plan

1) Railway Alignment Outline

The railway line with about 11.4 km in route length consists of about 2.2 km of tunnel section, 11.8 km of elevated track section, 2 numbers of underground stations and 11 numbers of elevated stations. Refer to Figure 3.5-1.

2) Standard Structure Plan

Underground Structure

There are two underground (UG) stations, the first one is in the starting station (km 0.0), the second one is in station (km 0.8).

Starting station (Sta. No.1) is under the Monivong Blvd. as a terminal station located in the center of city and expected to be used by many railway passengers. Island platform type is proposed in this station considering the convenience of railway passenger movement. The 9 m width of platform is planned considering the Up/Down escalators and 3 m staircase. Tunnel Structure will be constructed by open-cut excavation method from the point of economy as the tunnel length is short and Box-Culvert type structure is planned for tunnel section. The section access to the Starting Station is planned as two tunnels as the station has an island platform then the distance between railway lines is wide about 12 m. While, the section access to the 2nd Station is planned as a single tunnel as these has a siding platform and the distance between railway lines is narrow about 4m. The tunnel between Station No.11 and No.12 is planned as a single tunnel as well. Refer to the following drawings;

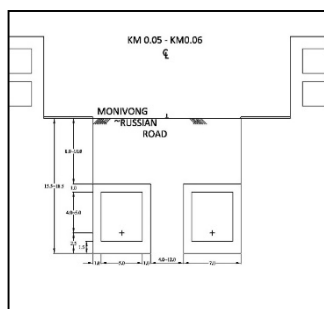

Source : PPUTMP Project Team

Figure 3.5-1 Two Box Tunnel

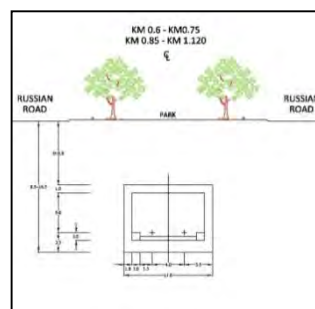

Source : PPUTMP Project Team

Figure 3.5-2 One Box Tunnel

Elevated Structure

There are 11 numbers of elevated stations starting from 3rd station (KM 2.3) to 11th station(KM 10.2) and 12th station (KM 12.2) to 13th station (KM 13.7).The location of the elevated stations are selected from the points where they are in better condition on construction and alignment on train operation. The distance between stations in city area are planned in short (0.7 km-1.5 km) and these in the out of city area are planned in comparatively long (1.5 km-2.0 km).

The elevated structure between stations consists of super-structure (PC Girder) and sub-structure (pier). The type of super-structure is planned as PC (Prestressed Concrete) Box Girder considering the economy and construction-ability. The type of sub-structure is selected from the points whether there is a space for construction of pier and foundation of the sub structure in the road median strip, or only available for the space in the both side of walkway (portal type pier). Refer to the following drawing.

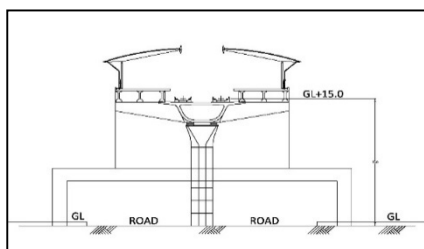

Source : PPUTMP Project Team
Figure 3.5-3 Elevated Station 1

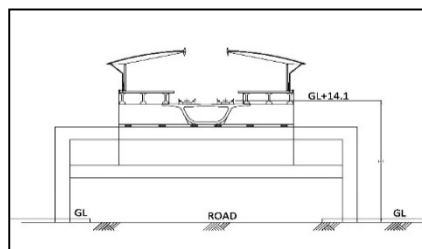

Source : PPUTMP Project Team
Figure 3.5-4 Elevated Station 2

3) Construction Planning

Pre-Construction Schedule

It is estimated to take about 4 years from the government approval of the Railway System Plan(Project) until the commencement of construction through the process of the Feasibility Study(FS), Detailed Design(DD) and Tender. as shown in the following period.

1. Feasibility Study (FS) : 12 months
2. Detailed Design (DD) :18 months
3. Tender : 12 months

Construction period

The construction of the civil works of the project will be carried out under and upper the main road connecting the city center and suburban area where there is many road traffic. Therefore, it is supposed that it takes time in comparison with other normal suburban new line construction due to the requirement of the special and temporary road relocation, special construction method, limitation of working time, many preparatory works before construction, etc. It is supposed to complete the elevated and underground works takes, at least, in about 4 years including the construction works of main structure, architect, track, signal & communications and test operation.

(2) Electric Power System Plan

1) Substation

Five substations will be constructed to supply train traction power and station/depot utility power at Station3, 6, 10, 12 and Depot.

This electric power will be received at the bulk AC substations from Electric Power Company via electric transmission lines with high performance, and feed power to traction substations and station service substations along the line. The bulk AC substation will be basically installed in the depot. However, one more bulk substation will be added at any place (near Station6 may be fitted) for a redundancy purpose.

An image of the power supply diagram of this line is shown in Figure 3.5-5.

Figure 3.5-5 Image of Power

Supply Diagram (in Case of 2 Bulk Substations)

Source : PPUTMP Project Team

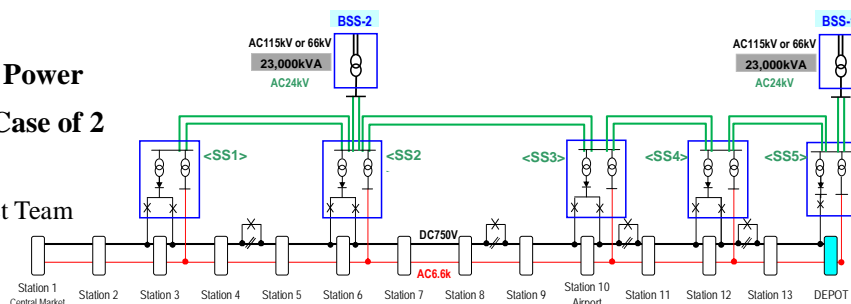

2) Contact Line

The traction voltage of the proposed AGT is DC 750V. The contact lines named “Third Rail” are arranged along one side of the elevated/underground tracks. There is a positive electrode and a negative electrode. Third rails are fixed to walls by insulators (Figure 3.5-6).



Figure 3.5-6 Image of Contact Line of AGT

Source : Mitsubishi Heavy Industries

(3) Signal and Telecommunication Plan

1) Signaling System

As transportation system candidates to proposed in this Pre-feasibility study (Pre-F/S), AGT (Automated Guideway Transit), LRT (Light Rail Transit), linear metro, etc. are mentioned, but in any case, we plan to propose CBTC (Communication Based Train Control) as an ATP (Automatic Train Protection).

CBTC is not a conventional fixed block system that depends on the track circuit, it can detect the train position onboard, and transmit it to ground system and following train by radio system. It is a signaling system to realize a moving block system.

CBTC can minimize the safety distance between trains. In addition, CBTC can respond the increase in the future traffic without upgrading the signaling system.

- The reason of CBTC adoption is as follows.
 - By using the radio system, CBTC can be lightly equipped, and can realize a system with high cost performance.
- The global standard has been established by IEEE1474 which achieve high safety.
- Recently CBTC has been adopted in many urban transport systems.
- CBTC can achieve the high-density traffic operation by the moving system.
- The future railway expansion is relatively easy by using the radio system.

General configuration of Automatic Train Protection (ATP) is shown in Figure 3.5-7.

Schematic diagram of signaling system is shown in Figure 3.5-8.

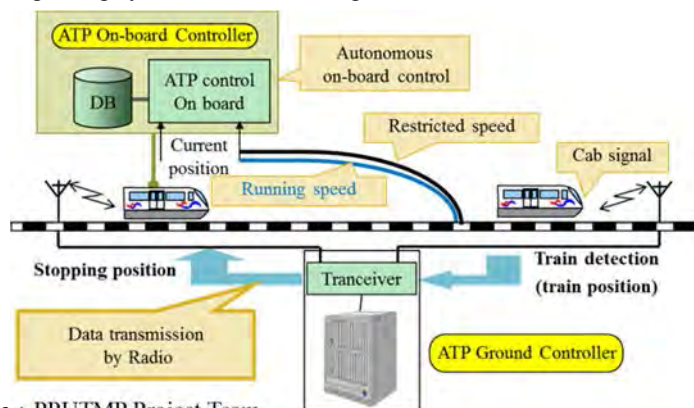

Source : PPUTMP Project Team

Figure 3.5-7 General Configuration of Automatic Train Protection (ATP)

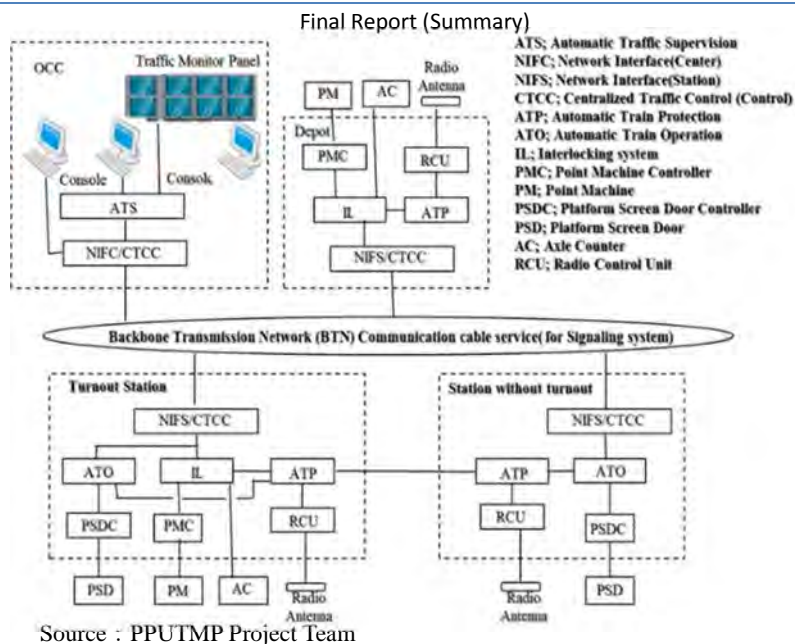

Figure 3.5-8 Schematic Diagram of Signaling System

2) Telecommunication System

As transportation system candidates to proposed to this Pre-feasibility study (Pre-F/S), AGT (Automated Guideway Transit), LRT (Light Rail Transit), linear metro are mentioned, but in any case, general configuration of Telecommunication system and required telecommunication service is shown in Figure 3.5-9.

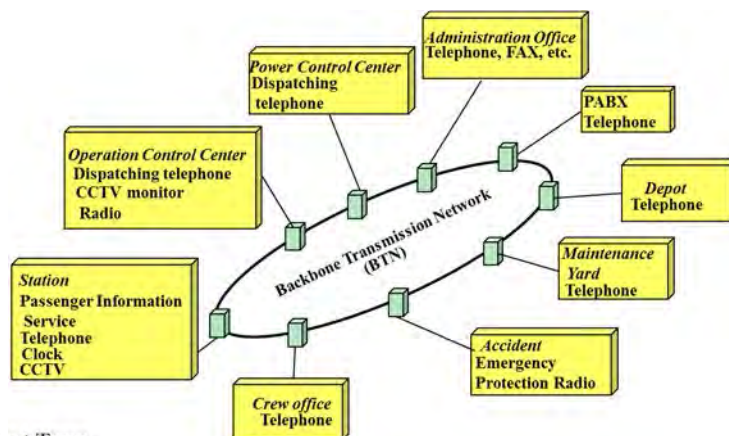

Figure 3.5-9 General Configuration of Telecommunication System

3.6 Economic and Financial Analysis

(1) Economic Analysis

● Overview

The objective of economic analysis is to assess economic effect of East-West Line Project from the point of national economy, and to clarify economic feasibility of the project.

Benefit = Saving of Vehicle Operation Cost and Travel Time Cost with East-West Line

Cost = Economic Cost which doesn't contain Physical Contingency, VAT and so on

Indicator = EIRR (Economic Internal Rate of Return) and B/C

● Result

EIRR of the Phnom Penh East-West Line is valued at 21%. Usually EIRR is required to exceed 12%. So This project is highly necessary and important for the Cambodian and Phnom Penh Economy.

Table 3.6-1 Summary of Economic Analysis

Project Life	Economic Cost (2014 price)	Economic Benefit	Evaluation Indicator	Result
40 years (2023-2062)	Initial Cost :685 mUSD(total) Replacement Cost :476 mUSD(total) OM Cost :7 mUSD(yearly)	156-237 mUSD (yearly)	EIRR=42% (>>12%) B/C=2.9	Economically Feasible

Source : PPUTMP Project Team

(2) Financial Analysis

● **Overview**

The objective of financial analysis is to assess a profitability of East-West Line Project. The main difference from economic analysis is a point to use an operating revenue and financial cost which include a contingency and VAT.

Revenue =Fare-box Revenue and Other Revenue(= 10% of fare-box revenue)

Cost =Financial Cost which contain Physical Contingency, VAT and so on

Indicator =FIRR(Financial Internal Rate of Return)

● **Result**

FIRR of the Phnom Penh East-West Line is valued at -0.3%. It means that even though this project is economically highly valuable, there is not profitability on a business basis.

In this study it is checked what kind of condition is necessary to turn positive. As a result, it is found that FIRR turns positive in case that other revenue increases by two times (10%→20%), and on top of that fare-box revenue increases by 10%, FIRR is valued at 1.3%.

Table 3.6-2 Summary of Financial Analysis

Project Life	Financial Cost (2014price)	Revenue(2014price)	Evaluation Indicator	Result
40 years (2023-2062)	Initial Cost :759 mUSD(total) Replacement Cost :530 mUSD(total) OM Cost :7 mUSD(yearly)	21 mUSD (yearly)	FIRR=-0.3%	Countermeasure is necessary.



Source : PPUTMP Project Team

Figure 3.6-1 Result of Sensitivity Analysis of Phnom Penh East-West Line

3.7 Environmental and Social Consideration

(1) Analysis on Social Impact

Result of preliminary assessment of social impact by the project is shown below.

Table 3.7-1 Summary of Social Impact

	Impact	Preparation Phase	Construction Phase	Operation Phase
Social Environment	Involuntary Resettlement	--	--	--
	Land acquisition	C	--	--
	Local economies	--	--	C
	Land use and utilization of local resources	--	--	C
	Social institutions	--	--	--
	Existing social infrastructures and services	--	C	--
	Poor, indigenous, or ethnic people	--	--	--
	Misdistribution of benefits and damages	--	--	--
	Local conflicts of interest	--	--	--
	Limitation of accessibility to information	--	--	--
	Gender	--	--	--
	Children's rights	--	--	--
	Cultural heritage	--	--	--
	Infectious diseases such as HIV/AIDS	--	C	--
	Health and sanitation	--	C	--
Water right and usage	--	--	--	
Accidents	--	C	--	
Access to sunlight	--	C	C	

Source : PPUTMP Project Team

NOTE: "A": significant, "B": some, "C": small, and "--" no impact

(2) Analysis on Natural Environmental Impact

Result of preliminary assessment of natural environmental impact by the project is shown below.

Table 3.7-2 Summary of Natural Environmental Impact

	Impact	Preparation Phase	Construction Phase	Operation Phase
Natural Environment	Topography and geology	--	C	C
	Soil erosion	--	--	--
	Groundwater	--	C	C
	Flow of hydrological features	--	C	C
	Biota and ecosystems	--	--	--
	Meteorology	--	--	--
	Landscape	--	C	C
	Global warming	--	--	--
Pollution	Air pollution	--	C	--
	Water pollution	--	--	--
	Soil pollution	--	C	--
	Waste	--	C	--
	Noise and vibration	--	C	C
	Ground subsidence	--	--	--
	Offensive odour	--	--	--
Bottom sediment	--	--	--	

Source : PPUTMP Project Team

NOTE: "A": significant, "B": some, "C": small, and "--" no impact

(3) Conclusion

No significant "Negative" impact is observed except for construction phase however, its size is small.

4. VERIFICATION OF TARGET PUBLIC TRANSPORT MODAL SHARE IN 2035 BASED ON THE SP SURVEY

4.1 Introduction

(1) Background

One of the planning targets of PPUTMP is the shift from private transport to public transport of Phnom Penh citizens, and the introduction of public transport in Phnom Penh Capital City is inevitable as it is the only capital city without public transport excluding para-transit in the Southeast Asian region. PPUTMP has set the target public transport modal share in 2035 at 30% based on the traffic congestion rate in the city center and the examples of other cities with public transport.

Phnom Penh citizens realize that the merits and demerits of a public transport system through the experience of the public experiment of city bus operation. After the public experiment, the number of bus routes has been increased from 1 to 3 routes plying not only the north and south but also the west and east covering major transport corridors in PPCC. Forty-three (43) second-hand buses from Korea were operated and 6,930 (average of 1 - 15 December 2014) daily passengers are served.

It was not expected that the city bus system would become the ordinary mode of transport for citizens in the city when PPUTMP started.

Considering above conditions, it was proposed that the verification of the target public transport modal share (30%) which was set during the master plan formulation be made through the conduct of a survey called Stated Preference (SP) survey.

(2) What is SP Survey?

SP survey is aimed at verification of target public transport modal share based on finding out which transport service plan will Phnom Penh citizens choose from by comparing between a rail transit system that is being planned for the western part of the city with several alternative service plans (variations of time and fares), and current transport modes and bus in operation in the city.

As stated above, the SP Survey focuses on putting forth several rail transit service plans that can be compared to the current transport modes in operation in the city. The selected survey interviewees are then asked to select their preferred transport service plan. For this purpose, there are two methods or approaches in questioning the interviewees in such a survey: (1) in the case where a rail transit service is provided which is capable of meeting the conditions of their current travel demand requirements; and (2) in the case where nothing is suggested to the current transport situation and interviewees are asked to imagine the future transport scenario. The selection of approach to use for the survey depends largely on the considerations of ease of answering the questions for interviewees. In the end, the first was used for the survey.

4.2 Overall Work Procedure

The data collected from the SP survey will be used to develop a Logit model in predicting the travel modes of interviewees based on the rates of selection between their present transport modes and the proposed rail transit transport mode. The present transport modes to be targeted in the survey are the passenger car, motorcycle and para-transit. In principle, the transport conditions or requirements shall include the origin-destination (OD), travel time, travel cost and other special features that are reflective of these trips.

In addition, a bus passenger interview survey will also be conducted and to know the user's characteristics and the consciousness of the modal choice.

In this manner, the Logit model can be calibrated in predicting more accurately the choice of transport modes among the residents.

Subsequently, the calibrated model is used to predict the future travel demand by mode (car, motorcycle and para-transit) based on growth trend. At the same time, the model is also used to predict the share of demand transferred from these travel modes to a future rail transit and bus service modes when it is introduced. Finally, the travel demand transferred to the new rail transit or

bus mode predicted by the model is essential in planning the transit routes as well as the number of passengers.

Then, public transport selection rate will be checked as to whether it is over or under 30%.

In the case of “less than 30%”, countermeasures for the improvement of public transport system such as development of convenient mode interchange areas will be proposed.

4.3 Survey Method (SP Survey for Current Mode Users and Bus Passenger Interview Survey)

The SP survey shall be conducted at the earlier stated four locations of mall/markets and on the three bus routes as shown in Figure 4.1-1. Passenger cars, motorcycles and para-transit users traveling in the city shall be asked regarding their preference of transport service.

Before conducting the SP Survey, information that explains clearly the features of the rail transit system must be prepared including a video clip. During the interview survey, such information shall be explained to interviewees first before seeking their answers to the questions in the survey form.

A sample size of 400 shall be targeted.

The interview survey for bus passengers shall be conducted along the 3 bus service routes and a sample size of 800 is targeted for this survey.

The SP Survey must be conducted by direct interviews with the car, motorbike, para-transit (motodop and tuk-tuk). At the same time, the survey should clearly indicate their trip purposes such as ‘to work’, ‘to school’ or other purposes.

A total target of 400 samples is to be collected for the SP survey for the current mode users. The samples are to be distributed evenly among the transport modes, that is, 100 samples per mode (car, motorbike and 2 para-transit modes).

For the interview survey for the bus passengers, it is basically an interview survey to be conducted with the bus passengers in the bus.

A total target of 800 samples is to be collected in the survey for the bus passenger. This shall be distributed by the passengers’ previous modes of travel. Hence 100 samples each must be collected from those whose previous travel mode is car (driver and passenger), motorbike (driver and passenger) or para-transit (motodop and tuk-tuk). Supplementally, bicycle and cyclo users are also to be collected 100 samples per mode.

4.4 Conduct of SP Survey

This survey is divided into two: The first is the SP survey to current mode users conducted at 4 locations (mall/markets) as follows: (1) Cham Chao to Pochentong Market, (2) Steung Meanchey Market, (3) Central Market and (4) Aeon Mall. Respondents’ travel modes are categorized into: (i) Car (privately owned), (ii) Motorcycle (privately owned) and (iii) Para-transit. Para-transit vehicles are divided into 2 types which are Tuk-tuk and Motodop. Total number of samples is 400, distributed as follows: 130 each of car users and motorcycle users, and 70 each of tuk-tuk and motodop users.

The second is an on-board bus interview covering three bus lines, namely, Bus Line No. 1 (A), Bus line No. 2 (B), and Bus Line No. 3 (C). Respondents’ previous travel modes are targeted for 8 classifications, which are as (1) Car passengers (privately owned), (2) Car drivers (privately owned), (3) Motorcycle passengers (privately owned), (4) Motorcycle drivers (privately owned), (5) Bicycle, (6) Motodop (only passengers), (7) Tuk-tuk (only passengers) and (8) Cyclo (only passengers). The number of samples targeted for each mode is 100 for a total of 800.

The bus interview survey was conducted from November 24, 2014 to December 3, 2014. For the SP survey for current mode users (mall/markets) and bus passenger interview survey, these were conducted from November 29, 2014 until December 4, 2014.

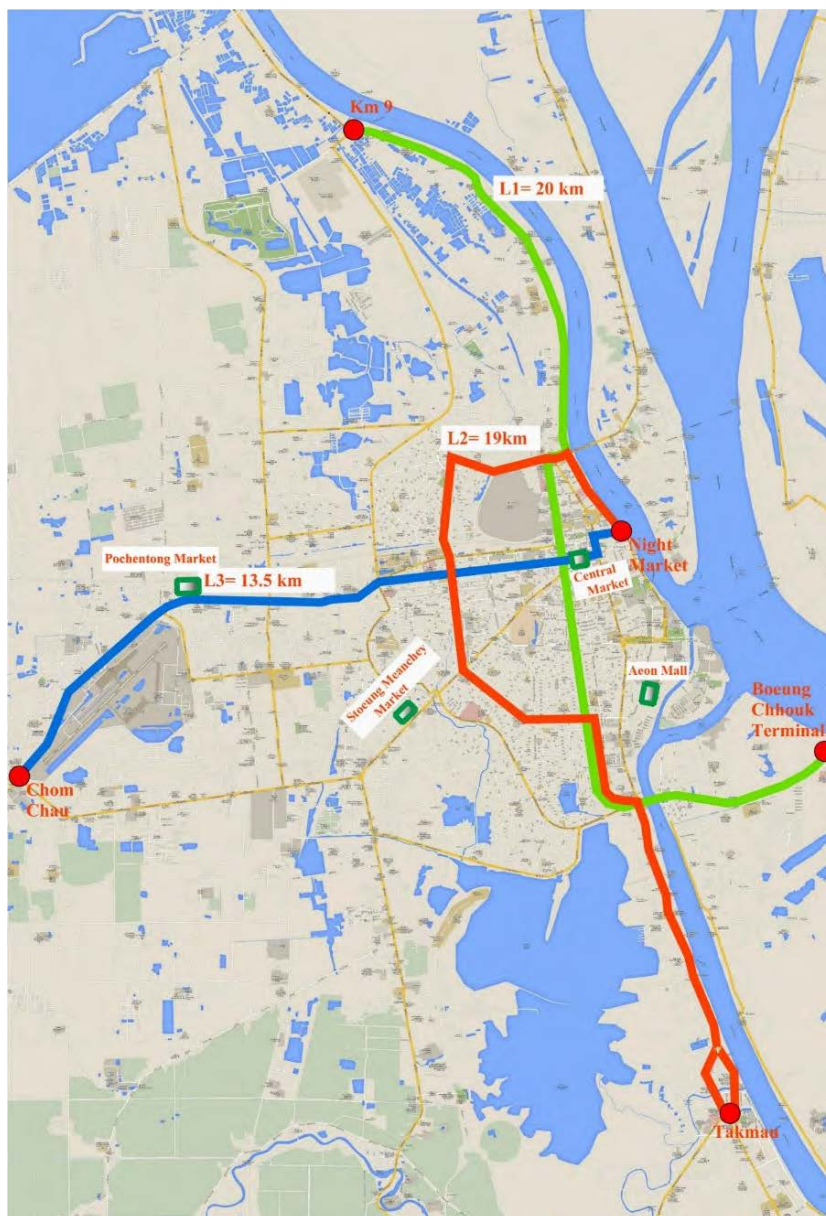

Source : PPUTMP Project Team

Figure 4.4-1 Survey Locations (3 Bus Routes and 4 Mall/Markets)

4.5 Comparison between Two Survey Results (Interviewee's Characteristics and Awareness of Modal Choice)

(1) Interviewee's Characteristics

Age of SP survey interviewees is a little younger than bus passengers' and number of female interviewees is bigger than male's.

Average number of family members is 4.8.

Number of motorcycles per family of SP survey and Bus Passenger Interview are 1.97 and 1.43, respectively. In the case of SP survey result, every 2.4 family members have one motorcycle.

84% of motorcycle users of SP survey interviewees have his/hers own motorcycle.

Even 61% of motorcycle users of SP survey interviewees (currently use) has not motorcycle license. This is one of the serious issues for the driver's education.

There is about 0.6 cars per family for both surveys. The highest is the car users (1.15 – 1.33/family).

63% of car users of SP survey interviewees have his/hers own car.

18% of current car users have not car license even when he/she drives.

About 50% of interviewees are students and company staff.

Average monthly income of SP survey interviewees and bus passenger interviewees are USD206 and USD167, respectively. Those with the highest monthly income are car users (about USD300).

(2) Consciousness to Modal Choice

From the consciousness survey of 15 items such as "short waiting time" for bus users and current mode users (SP survey), the findings are described below and shown in Figure 4.5-1 and Table 4.5-1.

1) All interviewees of the two surveys are most conscious of "low rate of accidents" (average rate: 1.70), "cheap fare" (1.48), "avoidance of exhaust gas and dust" (1.46) and "assurance of punctuality" (1.41).

2) Many of current motorcycle and para-transit users are satisfied with their modes.

3) Many of the bus users are conscious of "avoidance of exhaust gas and dust".

4) A big difference of items of consciousness between bus and current mode users are "current mode is most satisfactory (-0.65: 'minus' means that current mode users are higher than bus users)", "low rate of snatching (-0.57)" and "want to try the mode of transport in foreign countries (-0.48)".

(3) Evaluation of Bus Service by Bus Passenger

For evaluation of bus service of bus passengers who used either a motorcycle, a car or para-transit (motodop or tuk tuk) previously, para-transit users gave the bus the highest score.

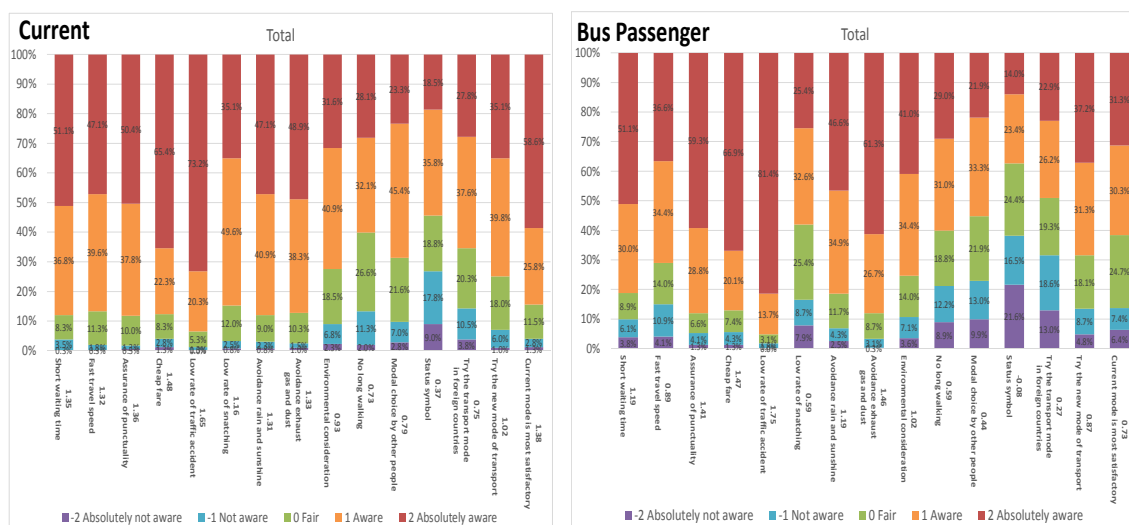

Source : PPUTMP Project Team

Figure 4.5-1 Awareness Survey of Modal Choice

Table 4.5-1 Consciousness Survey Results

Item	Motorcycle			Car			Para-transit			Total		
	Bus *1	Current *2	B-C	Bus	Current	B-C	Bus	Current	B-C	Bus	Current	B-C
(1) Short waiting time	1.22	1.26	-0.04	1.40	1.34	0.06	1.07	1.44	-0.37	1.35	1.19	0.16
(2) Fast travel speed	0.94	1.36	-0.42	1.20	1.31	-0.11	0.71	1.27	-0.56	1.32	0.89	0.43
(3) Assurance of punctuality	1.47	1.33	0.14	1.67	1.40	0.27	1.24	1.36	-0.12	1.36	1.41	-0.05
(4) Cheap fare	1.49	1.49	0.00	1.36	1.34	0.02	1.48	1.60	-0.12	1.48	1.47	0.01
(5) Low rate of traffic accident	1.73	1.67	0.06	1.82	1.66	0.16	1.76	1.63	0.13	1.75	1.65	0.10
(6) Low rate of snatching	0.65	1.20	-0.55	0.73	1.10	-0.37	0.47	1.17	-0.70	0.59	1.16	-0.57
(7) Avoidance rain and sunshine	1.22	1.33	-0.11	1.09	1.31	-0.22	1.17	1.30	-0.13	1.19	1.31	-0.12
(8) Avoidance exhaust gas and dust	1.45	1.34	0.11	1.60	1.28	0.32	1.42	1.35	0.07	1.46	1.33	0.13
(9) Environmental consideration	1.11	0.92	0.19	1.07	0.95	0.12	0.88	0.91	-0.03	1.02	0.93	0.09
(10) No long walking	0.50	0.83	-0.33	0.71	0.46	0.25	0.67	0.89	-0.22	0.59	0.73	-0.14
(11) Affected by modal choice of other people	0.40	0.80	-0.40	0.62	0.69	-0.07	0.44	0.88	-0.44	0.44	0.79	-0.35
(12) Status symbol	0.14	0.36	-0.22	0.16	0.32	-0.16	0.01	0.42	-0.41	0.08	0.37	-0.29
(13) Want to try the mode of transport in foreign countries	0.32	0.77	-0.45	0.29	0.85	-0.56	0.21	0.64	-0.43	0.27	0.75	-0.48
(14) Want to try the new mode of transport	0.95	1.03	-0.08	0.96	1.01	-0.05	0.74	1.02	-0.28	0.87	1.02	-0.15
(15) Current mode is most satisfactory	0.68	1.48	-0.80	0.76	1.16	-0.40	0.79	1.49	-0.70	0.73	1.38	-0.65

Source : PPUTMP Project Team

Note *1: Average score of bus passenger interviewees

*2: Average score of SP survey interviewees

B - C: *1 - *2

4.6 Analysis of SP Survey for Developing the Logit Model

(1) Development of SP Data

Based on the current transport modes in Phnom Penh, 3 types of data sets, namely, a) Motorcycle to Mass Transit, b) Car to Mass Transit and c) Para-transit to Mass Transit, were prepared and analysed. To minimize the work period of the analysis, only the conditions of level of service of “time” and “cost” were selected for the explanatory variable, even though it is possible to consider adding the personal characteristics.

(2) Binary Logit Model

A Binary Logit Model was selected for modelling of modal choice.

(3) Estimation of the Model Parameters

Results of the parameter calculation adopting the “Maximum Likelihood Estimation Model” using “R”, which is the statistical analysis software.

Table 4.6-1 Estimation of Model Parameters

【MC Transfer Model】				
Setting the Conditions	MC	UMT		
Time (min)	30	30		
Cost (Riel)	3000	5000		
【MC Transfer Model】	Estimation Value of Parameter		t value	Remarks
x1: Time (min)	-0.007018935	-0.007018935	-0.8006026	Common variable
x2: Cost (Rciel)		-0.000271279	-8.3504354	Alternative variable
x3: UMT inherent constant value		-0.079774107	-0.6373116	Alternative variable
x4: Cost (Rciel)	-0.000139276		-3.1462638	Alternative variable
Valuable value	0.533447051	0.192677269		
Estimated Modal Share	0.734649751	0.265350249		
【Car Transfer Model】				
Setting the Conditions	Car	UMT		
Time (min)	30	30		
Cost (Riel)	5000	5000		
【Car Transfer Model】	Estimation Value of Parameter		t value	Remarks
x1: Time (min)	-0.00489055	-0.00489055	-0.5611167	Common variable
x2: Cost (Rciel)		-0.000248045	-7.6132729	Alternative variable
x3: UMT inherent constant value		-0.040855525	-0.3375972	Alternative variable
x4: Cost (Rciel)	-0.000100422		-2.3105925	Alternative variable
Variable value	0.52265876	0.239837056		
Estimated Modal Share	0.685457873	0.314542127		
【PT Transfer Model】				
Setting the Conditions	PT	UMT		
Time (min)	30	30		
Cost (Riel)	5000	5000		
【PT Transfer Model】	Estimation Value of Parameter		t value	Remarks
x1: Time (min)	-0.106021828	-0.106021828	-11.5235249	Common variable
x2: Cost (Riel)	-0.000250556	-0.000250556	-10.63881501	Common variable
x3: UMT inherent constant value		-0.006864901	-0.08535164	Alternative variable
Variable value	0.011873647	0.011792415		
Estimated Modal Share	0.501716219	0.498283781		

Note: MC (Motorcycle), UMT (Mass transit) and PT (Para-transit)

Source : PPUTMP Project Team

4.7 Estimation of Public Transport Modal Share in 2035

4.7.1 Preparatory Work

Conditions of the transport network are stated below and shown in Figure 4.7-1.

- 1) Road network: 2035 Master plan network
- 2) Public transport network: Rail transit (UMT) network and bus network as illustrated in Figure 4.7-1

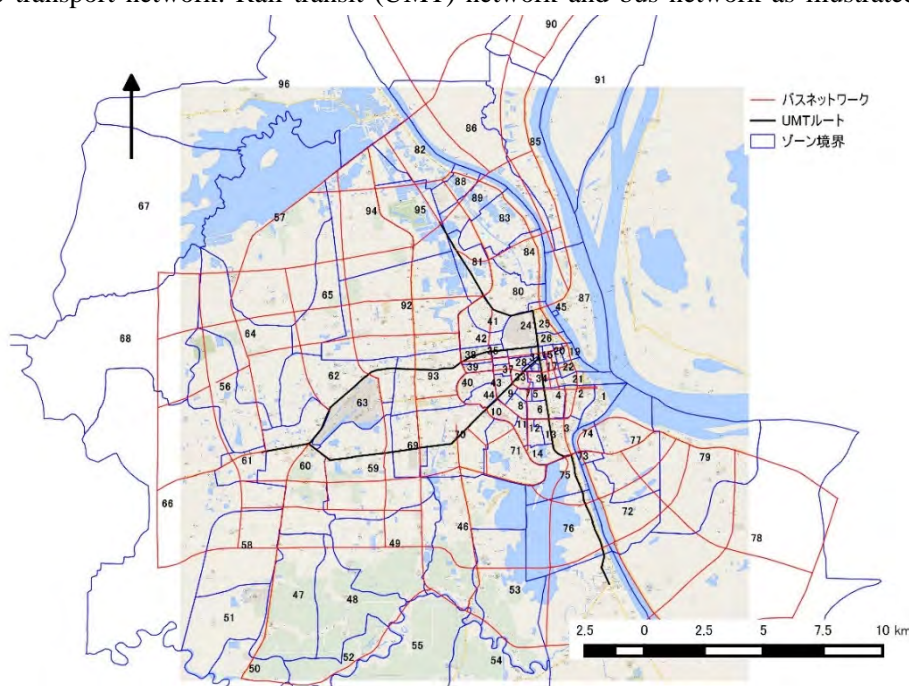

Source: PPUTMP Project Team

Figure 4.7-1 2035 Transport Network in Project Area

Trip time and distance between zones are estimated using Dijkstra's shortest path algorithm based on the 2035 master plan road network and public transport network.

The criteria of the shortest route research are the shortest route of time between zones and consideration the condition of link evaluation as shown in Table 7.2-1.

The distance and travel time of internal trips within a zone adopt the radius (distance) of a circle which is the same area with the zone, and is divided by the speed (mass transit: 4 km/h. and MC and Car: 20 km/h.).

Table 4.7-1 Criteria of the Shortest Route Research

Type of link	Length of link	Speed	Remarks
Road	Length of line on GIS		Congestion rate which came from assignment results is substituted for BPR formula and changing the speed
Mass transit (UMT)	ditto	30 km/h	Full network
Mass transit (Bus)	ditto	Same as road network	
Zone access	ditto	4 km/h	
Mass transit (UMT access)	Measuring the length of line on GIS from zone node to the station	4 km/h	
Mass transit	Same as road network	4km/h.	The research between zones is possible

(Dummy link access)			only for the UMT and bus network: therefore, the road network is set as dummy links and travel speed is constant (4 km/h.).
---------------------	--	--	---

Source: PPUTMP Project Team

4.7.2 Results of the Simulation (Base Case)

(1) Estimation result of number of transferred trips by mode adopting Binary Logit model

Number of mass transit (UMT and bus) trips is 1,656,327 trips/day.

Public transport modal share is 28.4% excluding walk.

(2) Estimation result of number of transferred trips by mode considering the mass transit coverage area (for verification of 1))

For the verification of results by Binary Logit Modal, an estimation is made of the transferred trips by considering the mass transit coverage areas, namely, UMT coverage area = 500 m from the UMT route and Bus coverage area = 200 m from bus route. The estimation result of this case is 1,656,241 trips/day. This is almost the same number of trips as calculated by the Binary Logit Model.

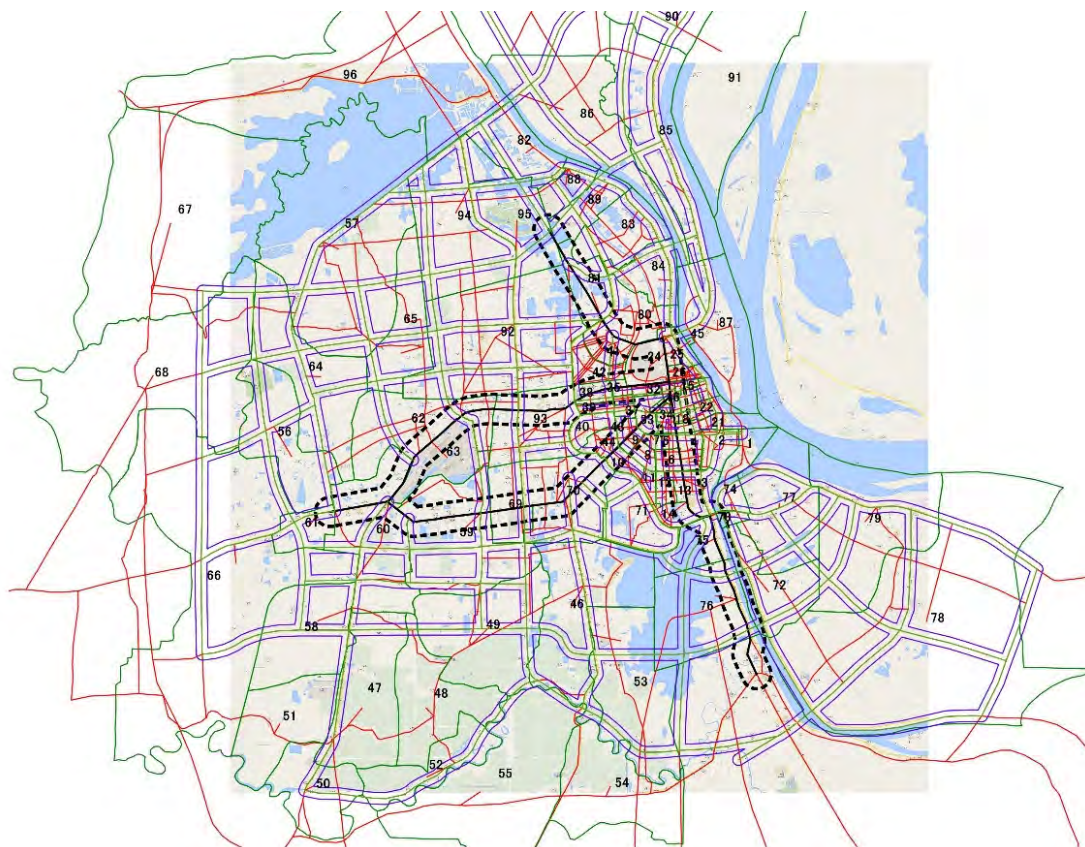

Source: PPUTMP Project Team

Figure 4.7-2 Urban Rail Transit and Bus Coverage Area

4.7.3 Correction of the Parameters of the Binary Logit Model

There seems to be a selectivity bias in the stated preference (SP) survey results analysis in the case of users of private mode, such as motorcycles and cars, because of their lack of experience of using public transport. Therefore, an examination and correction of the parameters of the Binary Logit Model are performed assuming the previous mode share as the revealed preference (RP) data.

(1) Bus Route related to Bus Passenger Interview Survey and Related OD

Current bus route-related OD trips between zones were extracted from existing OD data (2012). Figure 4.7-3 shows current bus routes and zones in Phnom Penh.

The extracted number of trips by mode is as follows:

- MC: 709,840 (67.4%)
- CAR: 125,210 (11.9%)
- Para-transit: 218,358 (20.3%)

And the zone indicators of the related zones are as follows:

- Area (sq. km): 144.35
- Population in 2012: 854,100



Figure 4.7-3 Zoning Map and Current Bus Routes in Phnom Penh

Source: PPUTMP Project Team

(2) Estimation of Bus Passengers in 2012 based on RP

Number of bus passengers in 2012 based on RP were estimated 180,000 based on the following data.

1) Public Transport Market Share vs. Public Transport Supply

Based on Figure 4.7-4, number of annual vehicle x km per hectare in bus influence are in Phnom Penh is 1,271 and the public transport market share is 15% to 20% (158,000 – 210,000 bus passengers).

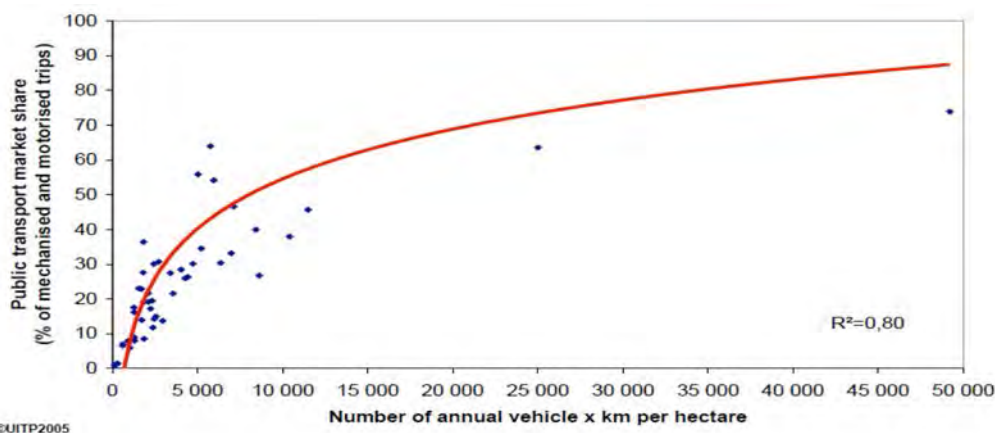

Source: Mobility in Cities Database, 2005 (Jean Vivier, International Association of Public Transport)

Figure 4.7-4 Number of Annual Vehicle * km per Hectare vs. Public Transport Market Share

2) Bus Modal Share in Hanoi in 1995

The bus modal share in Hanoi in 1995, which was the year when bus operation in Hanoi started.

(3) Comparison of Number of Public Transport Transferred Trips and Ratio between SP-based and RP-based

Estimation of bus passengers and transferred share by mode in 2012 based on RP, and comparison between SP-base and RP-based are shown in Table 4.7-2 and Table 4.7-3, respectively.

Table 4.7-2 Summary of RP-Based PT Transferred Trips and Share

Mode	Previous Modal Share (Bus Passenger Interview Survey)	Number of Bus Passengers by Mode	Share of Bus Passengers by Mode
MC	53%	95,400 =180,000*53%	13.44% =95,400/709,840
CAR	10%	18,000 =180,000*10%	14.38% =18,000/125,210
Para-transit	37%	66,600 =180,000*37%	30.50% =66,600/218,358
Total	100%	180,000	17.09%

Source: PPUTMP Project Team

Table 4.7-3 Comparison of PT Transferred Trips and Share between SP Based and RP Based

Mode	Total Trips	Number of Public Transport Transferred Trips (Transferred Ratio)	
		SP-based (from SP Survey)	RP-based (from Bus Passenger Interview Survey)
MC	709,840	282,852 (35.6%)	95,400 (13.44%)
CAR	125,210	55,658 (44.5%)	18,000 (14.38%)
Para-transit	218,358	45,753 (21.8%)	66,600 (30.50%)
Total	1,053,408	356,023	180,000

Source: PPUTMP Project Team

(4) Result of Recalculation of the Public Transport Users' Trips by the Adoption of the Transferred Model after the Correction of Parameters

As mentioned earlier, because of the selectivity bias found in the SP survey results, an examination and correction of the parameters of the Binary Logit Model are done assuming the share by previous modes as the revealed preference data. However, correction of parameters of Binary Logit Model does not directly use the RP-based figures because the public transport system in 2035 is not only bus but rail transit + bus. Therefore, the figure from RP is corrected and shifted to the SP-based figure side.

Table 4.7-4 Estimation of the Number of Public Transport Trips and Modal Share in 2035 in Comparison between Before and After Correction

Items	Before Correction	After Correction
Estimated Number of Public Transport Trips in 2035	1,656,327	1,377,821
Modal Share of Public Transport (excluding walk)	28.4%	23.6%

Source: PPUTMP Project Team

(5) Sensitivity Analysis

As discussed in Section 7.2 (3), the factors that affect the public transport share are operational speed of rail transit, transfer time and public transport fare. Based on this, the sensitivity analysis using the change of the service level of the public transport is adopted in order to observe the change of the public transport share using the following 3 cases.

Table 4.7-5 Conditions and Cases by the Influence Factor for the Sensitivity Analysis

Case	Operation Speed of the Rail Transit (km/hour) *	Transfer Time (minutes)	Public Transport Fare (riel)
High Case	35.0	+5.0	1,000
Base Case	30.0	+10.0	1,500
Low Case		+15.0	2,000

Note: According to the pre-F/S of the trail transit, planning operation speed of rail transit is 30km/hour and it is possible to increase up to 35km/hour.

Source: PPUTMP Project Team

The result of the sensitivity analysis is shown in Figure 4.7-5. It can be said that the target public transport share in 2035 of 30% can be achieved by the improvement of operational services of the rail transit, development of convenient mode interchange areas such as stations, terminals and bus stops and the effort of the public transport fare policy based on the public transport system development.

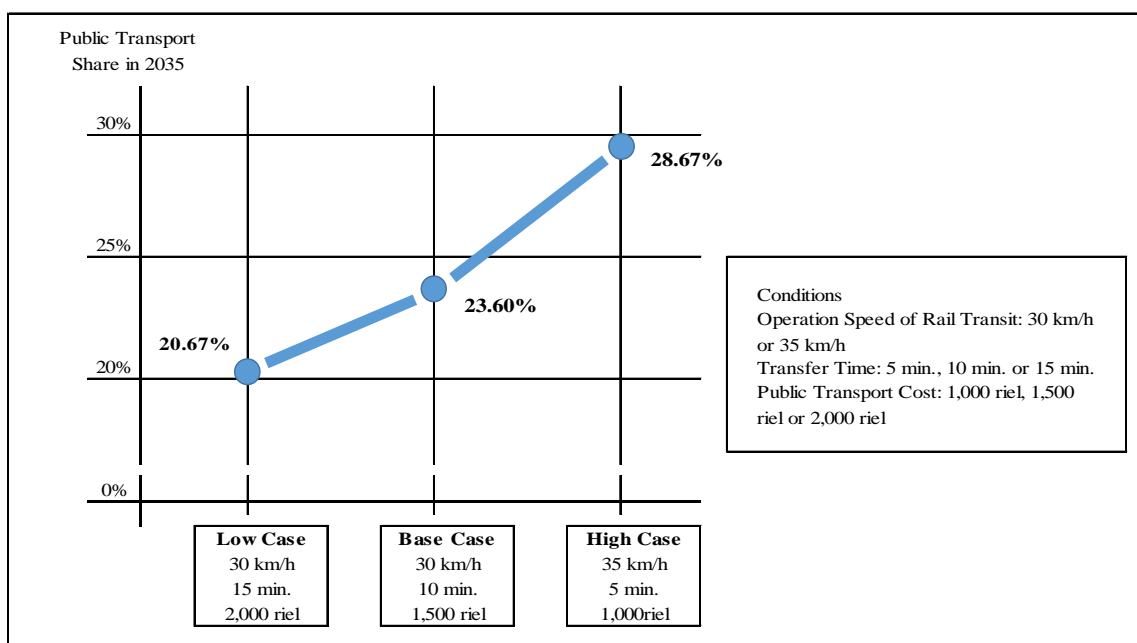

Source: PPUTMP Project Team

Figure 4.7-5 Result of the Sensitivity Analysis