

Draft



KINGDOM OF CAMBODIA

Overview on Transport Infrastructure Sectors in the Kingdom of Cambodia



2010

Infrastructure and Regional Integration

Technical Working Group

(IRITWG)

Contact address:

IRITWG Secretariat
4th Floor, Eastern Building,
Ministry of Public Works and Transport
Tel. 855 23 724 565
E-mail: psovicheano@online.com.kh

Preface

The Infrastructure and Regional Integration Technical Working Group (IRITWG) is proud to publish the 3rd edition of the “Overview on Transport Infrastructure Sectors in the Kingdom of Cambodia.”

The 1st and 2nd editions were published as of January 2008 and January 2009 respectively with the following purpose: (1) To prepare a strong basis for the future planning in the transport infrastructure sectors. (2) To share the basic information and the overall picture concerning the transport infrastructure sectors among the related organizations, development partners, etc.

Publication of the 1st and 2nd edition has achieved a huge step forward and has been appreciated by both public and private sectors as it were the only official documents that briefly illustrate the whole transport infrastructure sectors in Cambodia.

As the infrastructure development in Cambodia is so rapid that the IRITWG has been aware of the necessity of updating the “Overview on Transport Infrastructure Sectors,” and thanks to the effort of all stakeholders, the 3rd edition in 2011 is now available in your hand.

We hope that this new edition will be useful for planning and implementation of transport infrastructure development in Cambodia, and we will put forth our best endeavors to continue to provide and improve next updated versions.

Chair of the IRITWG

Lead Facilitator of the IRITWG

H.E. Tram Iv Tek

Minister of Public Works and Transport

Mr. Suzuki Yasujiro

Chief Representative, JICA Cambodia Office

TABLE OF CONTENTS

1. Roads.....	1
2. Railway	18
3. Maritime and Ports	23
4. Inland Waterway.....	35
5. Air Transportation	41
6. Cross Border Transport	46

1. ROADS

1.1. BACKGROUND

During the 1980s the state had a monopoly on all commercial transport, including goods and passenger transport. The services were run by state enterprises. Some enterprises were national and supervised by the Ministry of Transport, Post and Tele-Communication (MTPT) or provincial government.

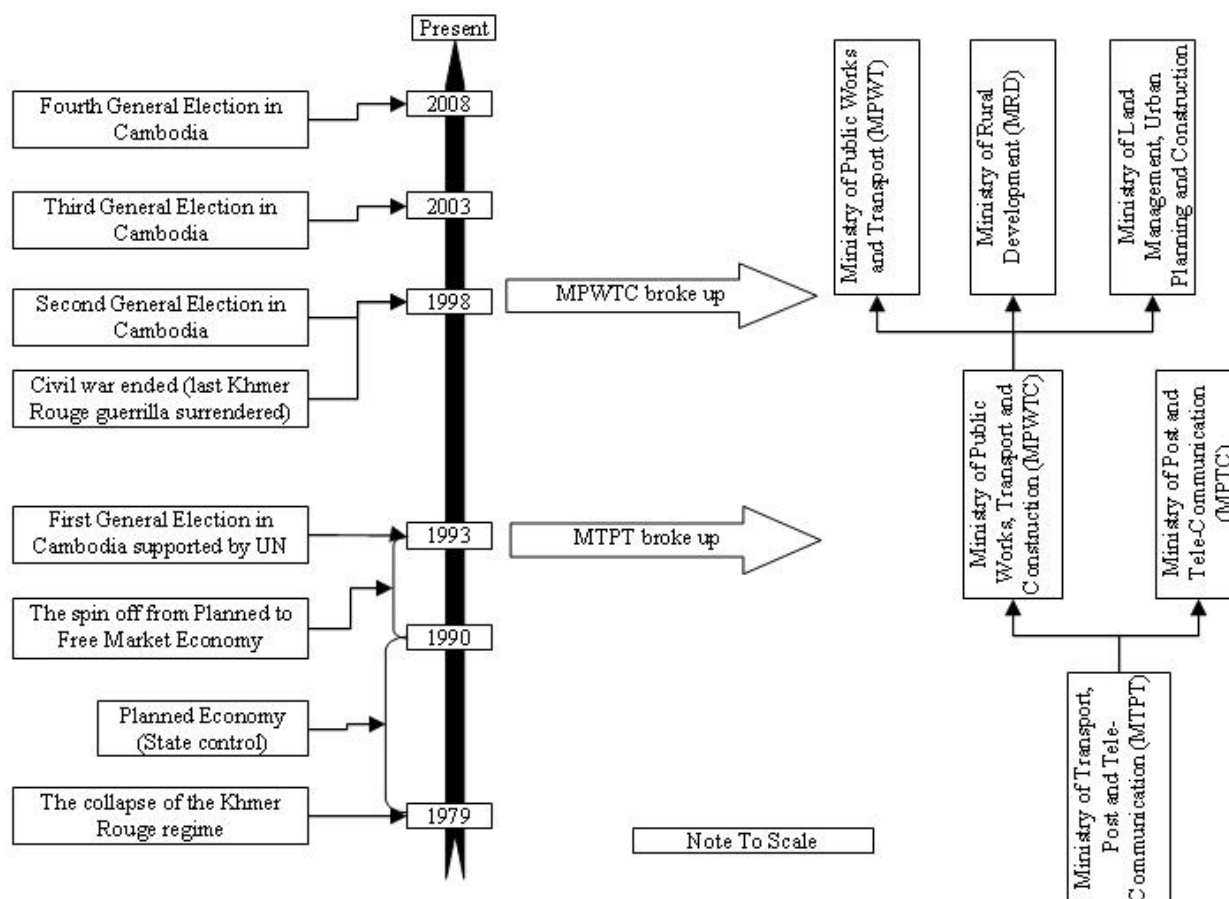

Figure 1-1: The evolution of MPWT

In late 1980s and early 1990s, the government policy evolved from planned to free market economy. Private company dealing with transport, infrastructure construction/rehabilitation emerged and state controlled enterprises lost out very fast and most have since been privatized or been dissolved. The change had also been seen at the ministry level both during the first general election in Cambodia in 1993 and also in the second general election in 1998. In this evolution, as shown in Figure 1-1, the MTPT had been divided into four ministries:

- Ministry of Post and Tele-Communication (MPTC): in charge of Mail and electronics communication
- Ministry of Public Works and Transport (MPWT): in charge of Nation & Provincial Road, Inland and Maritime transport, Railways and Airport¹
- Ministry of Rural Development (MRD): in charge rural road
- Ministry of Land Management, Urban Planning and Construction.

In conjunction with political stability and with the support from international community, Cambodia's infrastructure has been seen growing rapidly: Numbers of National Roads have been rehabilitated/asphalted, Bridges have been constructed and similar development trend has been seen in other transport sectors. The negative outcome of this development could be seen in the increase of road accident and the abuse of overload transport, where the government had taken measure to tackle these problems seriously.

¹ This task is shared with State Secretariat of Civil Aviation (SSCA)

1.2. Asian Highway: Cambodia

A Cambodian road network is part² of the Asian Highway (AH) No.1, No.11 and No.123. AH No.1 is the longest route of the Asian Highway Network, running 12,845 miles (20,557 km) from Tokyo, Japan via Korea, China, Southeast Asia, India, Pakistan and Iran to the border between Turkey and Bulgaria west of Istanbul.

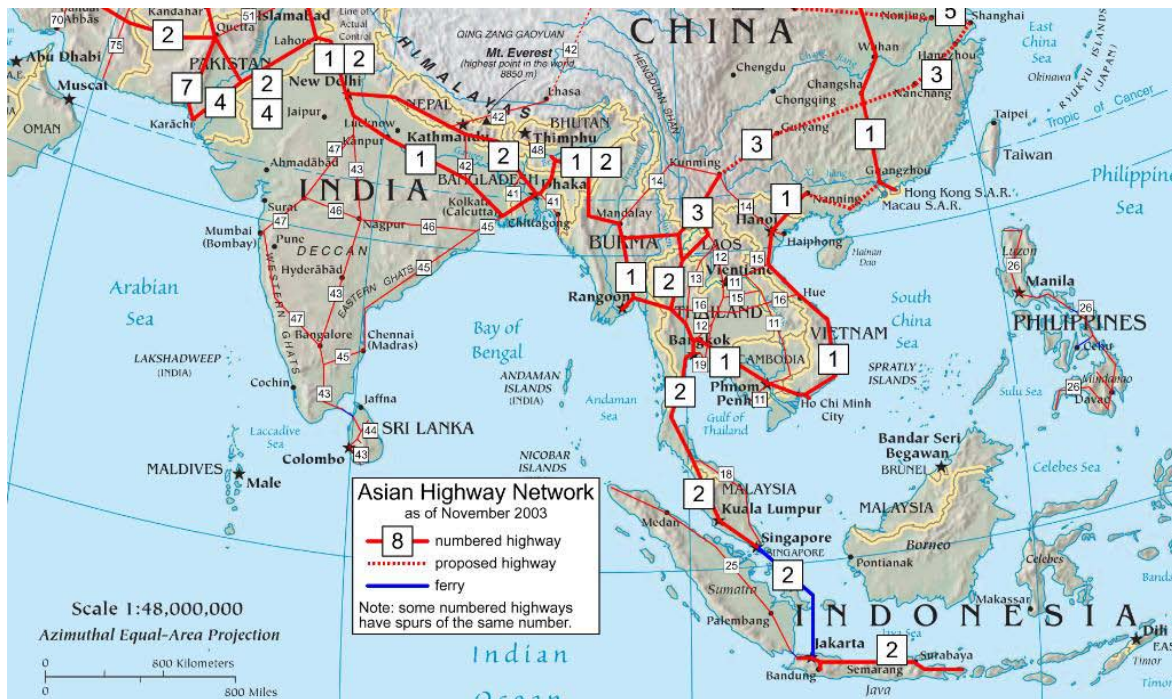

Figure 1-2: Asian Highway

Source: ESCAP

1) Roads, bridges and ferries

The road network in Cambodia consist of 5,205km National Road (2,119km are 1st digit and 3,086km are 2nd digits), 6,413km provincial road and 33,005km rural road (as of September 2010).The National Road are mostly primary road network links Phnom Penh to provincial capitals and important centers of population and economic activity. Most roads were constructed in the 1920s and 1930s to serve light vehicular traffic. Originally about 2,400 km of the national road network was paved with asphalt or bituminous material, but over the years, through negligence (due to civil war from 1970 – 1998) and the effects of flooding and traffic, much of this pavement has disappeared. The maximum Gross Vehicle Weight (GVW) allowed on Cambodian roads at present is 20 tonnes. Ferries are operated by The Ministry of Public Works and Transport at key locations: NR 1: Neak Loeung, NR 6A: Prek Tamak, Prek Kdam (until April 2010). Other river crossing services are operated by local authorities/private.

2) Road traffic and transports

a. Passenger transport

Passenger transport suffers from a lack of adequate vehicles. Motor cycles with or without trailers carry significantly more passengers than private cars and pick- ups, although mainly for short distances. Most motor cycles are small, with cylinder volumes in the range 70-100 cc. Shared taxi is the predominant mode for public transport, with some 50% of the total number of passengers -km on the primary roads. Older, medium size saloon cars are used for the purpose and carry an average of no less than seven passengers. Most of the remaining such traffic is carried by converted pick-ups, with an average seating capacity of 12 and an average occupancy of 11 passengers. Regular buses are very few even though there is an obvious market. The state Passenger Transport Company has a de facto monopoly and provides some services along Roads 1 a 7, using mainly Soviet PAZ buses with 23 seats. The average occupancy rate for these buses is about 60%, very much less than for the private taxis.

² Cambodia occupied 1,339 km out of 140,479 km of total AH (Source: Wikipedia, 2010)

b. Goods transport

Most vehicles for goods transport as observed on the primary roads were imported during 1980-1991 under a favourable trade agreement with former Soviet Union. The main types are MAZ, with two axles and an eight tonne nominal load capacity and KAMAZ with three axles and a ten tonne load capacity. On average for the main road network two-axle trucks constitute about half of the fleet and carry about one third of the goods volume in tonne-km. On Road 4, in particular, many three-axle trucks also pull trailers for an additional ten tonne capacity. The maximum size of trucks is formally restricted by the general 20 tonne limit for the gross vehicle weight, and further by the load restrictions for individual bridges. Larger trucks, such as articulated vehicles, are very few. There is still no organized import of new trucks, as there is for light vehicles. The legislation relating to commercial transport services was liberalized in 1990. Operators have to be registered as businesses, for tax purposes, and need a license issued by the transport department of MPWT. According to MPWT such licenses are normally granted to all applicants on payment of a small fee.

c. Traffic volumes and characteristics

There have been few systematic traffic studies in Cambodia since the 1960s. Traffic counts at some forty different sites, covering one day at each site, were conducted by MPWT in 1993. Few road sections outside the main urban areas have traffic volumes exceeding 1,000 vehicles per day and none more than about 3,000 (excluding motor cycles). The average for all primary roads is some 500 vehicles with four or more wheels, plus 1,600 motor cycles per day (weighted average for Roads 1- 7). However, this average includes long sections of Roads 6 and 7 which can hardly be passed at all at present. The composition of traffic is similar along most main roads, except where the road or bridge conditions limit the use of some vehicle types. The number of motor cycles with or without trailers is generally two to five times the number of vehicles with four or more wheels. Of the light vehicles, about half are shared taxis or public passenger vehicles. Heavy vehicles constitute 10-20, of the total traffic flow excluding motor cycles.

d. Origins and destinations

About 80% of all long distance (inter- provincial) transport of both goods and passengers, observed in the origin-destination survey, was either to or from Phnom Penh. The aggregate figures for the whole country are likely to be somewhat lower, but the results clearly show Phnom Penh's dominating role in the economy. However, there are also substantial inter- provincial movements between the north- western provinces of Siem Reap, Banteay Meanchey and Battambang. Many of these goods originate in Thailand. Most of the trade with Vietnam is either local or transshipped at the border, hence very little traffic to/from Vietnam was detected in the surveys. If traffic from Sihanoukville port is excluded, the volume of goods transported by road to Phnom Penh is the same order of magnitude as the volume from Phnom Penh. For most other provinces the volume of domestic exports is also the same order of magnitude as the domestic imports. The goods flows by road are thus quite well balanced, which helps explain the high load factors. There is almost no traffic at all through Phnom Penh, such as between Roads 4 and 5 or between Roads 1 and 5.

e. Trip purposes and types of commodities

The main reason for passenger trips is "personal business", accounting for more than half of all replies. Only some 10% of all passenger trips are duty trips, i.e. undertaken during paid working time.

1.3. The role of infrastructure in Cambodia's Economic Growth, Poverty Reduction and Trade Integration

The accessibility to the infrastructure by the Cambodian people remains the lowest in Asia (see Table 1-1).

Table 1-1: Infrastructure Access Indicators in Selected ASEAN (% of total population)

Infrastructure	Cambodia	Indonesia	Myanmar	Viet Nam	Note
Electricity	10.0	80.0	5.0	60.0	Electricity: Access to electricity network; Water: access to improved water sources; Sanitation: access to improved sanitation; Teledensity: telephone subscribers per thousand population; Road density (population): road km/ 1,000 people; Road density (area): road km/ 1,000sq.km; -- where data is not available
Water	34.0	78.0	80.0	73.0	
Sanitation	16.0	52.0	73.0	41.0	
Teledensity	38.0	127.0	8.0	88.0	
Road Density (population)	1.0	1.7	-	1.2	
Road Density (area)	70.0	203.0	-	287.0	

Source: Estache and Goicoechea 2005.

With less accessibility to infrastructure compounded with least infrastructure development (see Table 1-2) thus created the inequality in infrastructure development, which further implicated the reduction of poverty level, income inequality and development gap.

Table 1-2: Ranking of ASEAN Countries According to the Level of Infrastructure Development

Country	1991		2000		2005		Note
	Index	Rank	Index	Rank	Index	Rank	
United States	25.96	1	22.95	1	20.66	1	Index= Research and Information System for Developing Countries Infrastructure Index (RII) where $R_{i,t}$ =RIS Infrastructure Index of the i-th country (104 countries) in t-th time (namely, 1991, 2000, 2005), $W_{j,t}$ =weight of the j-th aspect of infrastructure in t-th time, and $X_{j,t}$ =value of the j-th aspect of infrastructure for the i-th country in the t-th time point. Each of the infrastructure variables is normalized for the size of the economy so that it is not affected by the scale. The $W_{j,t}$ are estimated with the help of principal component analysis (PCA). The aspects of infrastructure covered in the construction of the composite index are transport infrastructure, ICT infrastructure, Energy infrastructure and Financial Infrastructure. Detailed explanation is in Kumar and De (2008)
Japan	16.28	5	18.65	4	18.58	2	
Singapore	15.73	6	20.11	2	17.66	3	
Malaysia	5.10	37	8.65	27	9.21	29	
Thailand	4.17	43	5.48	38	5.89	42	
Viet Nam	0.91	92	1.85	75	3.27	61	
Indonesia	2.23	69	2.74	63	3.21	62	
Philippines	1.53	76	2.58	65	2.95	63	
Lao PDR	0.55	99	1.19	84	0.87	92	
Myanmar	0.97	90	0.79	91	0.76	95	
Cambodia	0.45	100	0.66	93	0.55	98	

Source: ADB

1.4. Present State of Roads in Cambodia

The road network in Cambodia is composed of arterial roads that are managed by the Ministry of Public Works and Transport (MPWT) and rural roads managed by the Ministry of Rural Development (MRD). Pavement and Bridge status are as below:

Table 1-3: Road network length

Road Classification	Length (Percentage)	No. of Bridges (Percentage)	Bridge Length (Percentage)	Management Authority
1-digit national roads	2,117 km (4.7%)	589 (14.5%)	17,643 m (23.1%)	MPWT
2-digit national roads	3,146 km (7.0%)	698 (17.2%)	15,710 m (20.6%)	
3,4-digit Provincial roads	6,441 km (14.4%)	904 (22.3%)	16,309 m (21.4%)	
Rural roads	33,005 km (73.8%)	1,869 (46.0%)	26,559 m (34.8%)	MRD
Total length	44,709 km (100%)	4,060 (100%)	76,221 m (100.0%)	

Note: MRD figures are as of September 2010; MPWT road figure as of 2009 and bridge figures is as of 2006

Source: MPWT and MRD

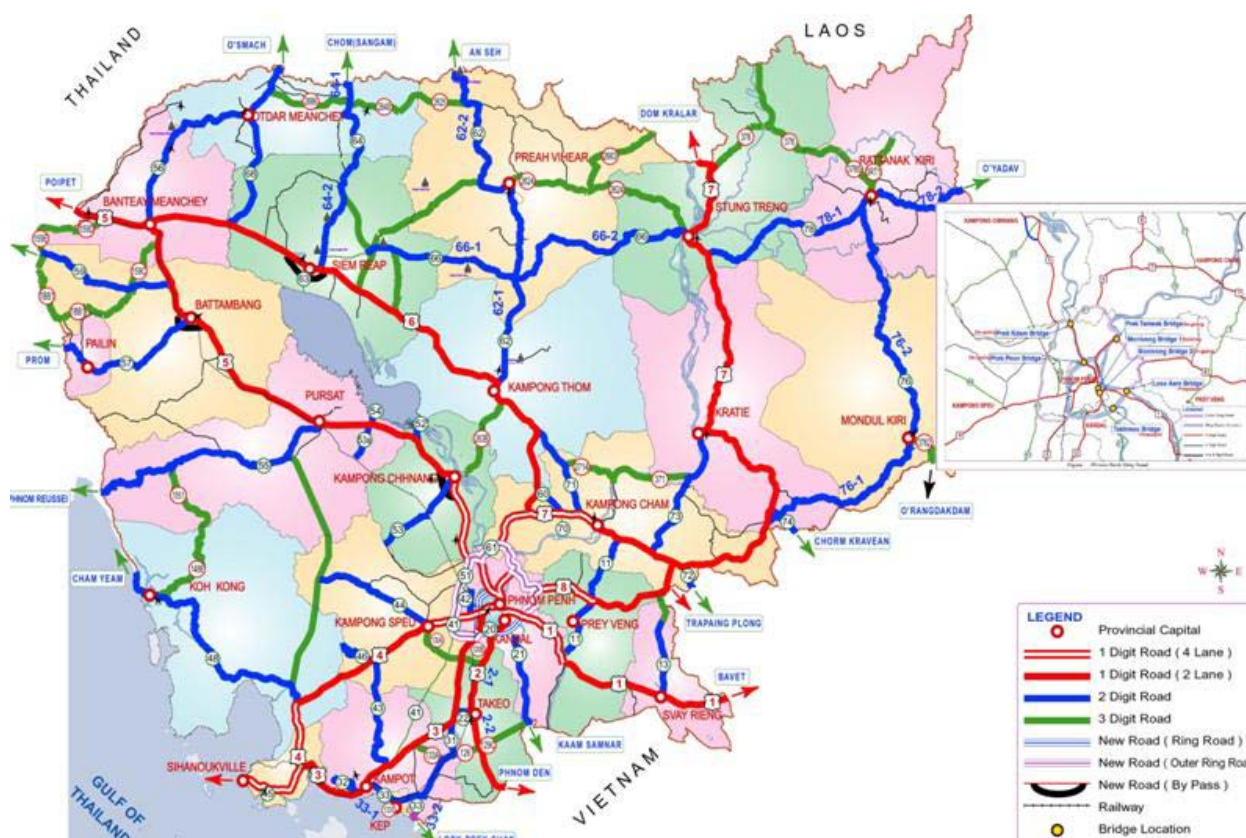

Source: MPWT

Figure 1-3: National Road Network in Cambodia

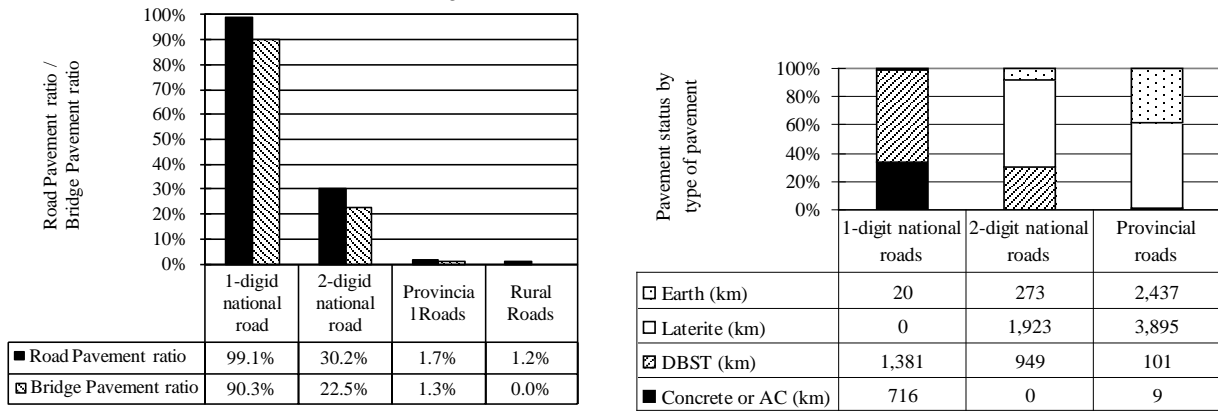

Note: The section under construction is assumed to be finished.

Source: MPWT & MRD

Figure 1-4: Road pavement ratio (as of 2009) and ratio of permanent bridges (as of 2004)

Source: MPWT

Figure 1-5: Pavement status by road classification (as of 2009)

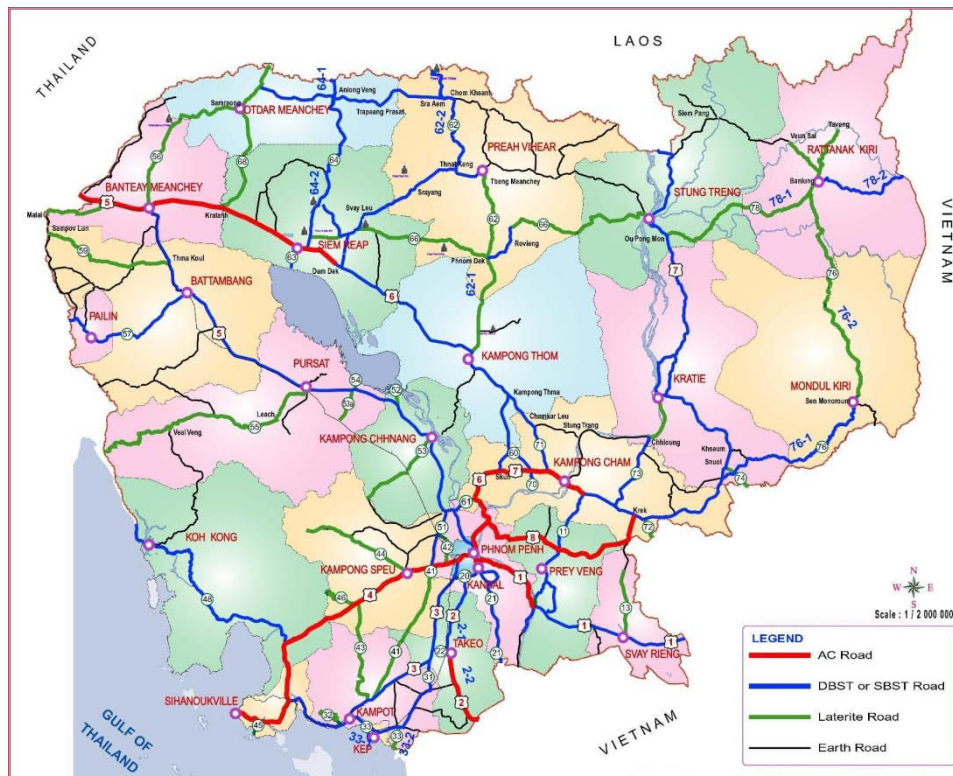

Note: The section under construction is assumed to be finished

Source: MPWT

Figure 1-6: Pavement Status

Road widths: 99% of 1-digit national roads have at least two lanes, while only 52% of 2-digit national roads and 15% of provincial roads have two or more lanes.

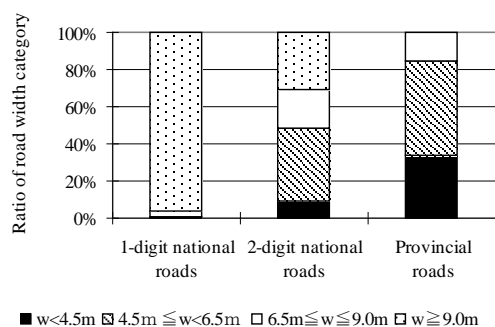

Note: For 1-digit national roads, data for $w \geq 9.0m$ is actually that for $w \geq 10.0m$, and $6.5m \leq w \leq 9.0m$, that for $6.5m \leq w \leq 10.0m$

Source: MPWT

Figure 1-7: Road lengths according to road widths (as of 2009)

1.5. International roads

A portion of national roads No. 1 and No. 5 make up a part of Asian Highway 1; national roads No. 4, 6 and 7 make up a part of Asian Highway 11; national roads No. 48, 3 and 33 make up a part of Asian Highway 123; and national roads No. 66 and 78 make up a part of the arterial highway of the Greater Mekong Sub-region (GMS).

Table 1-4: International roads in Cambodia

Name of international road			Transit Cities	Length (km)	International Road Classification				
GMS roads	Asian Highway	ASEAN Highway			Primary	Class I	Class II	Class III	Below Class III
Central Sub-corridor	AH1	AH1	Poipet-Sisophon (NR5)	47.5			47.45		
			Sisophon - Phnom Penh (NR5)	360.0				360	
			Phnom Penh - Bavet (NR1)	164.0				107	
			Sub-total Length (km)	571.5			104.45	467	
Inter-Corridor	AH11	AH11	Phnom Penh - Sihanouk Ville (NR4)	226.4			226.4		
			Phnom Penh - Skun (NR6)	75.0			75		
			Skun-Kampong Cham (NR7)	49.0			49		
			Kampong Cham - Trapengkreal (NR7)	411.8				411.83	
			Sub-total Length (km)	762.2			350.4	411.83	
Southern Coastal Sub-corridor	-	AH123	Cham Yeam - Koh Kong (NR48)	13.0			13		
			Koh Kong - Sre Ambel (NR48)	138.0				138	
			Sre Ambel - Viel Rinh (NR4)	42.0			42	0	
			Viel Rinh - Kampot (NR3)	36.0				36	
			Kampot - Lork (NR33)	51.8				51.8	
Sub-total Length (km)	280.8			55	225.8				
Northern Sub-corridor	-	-	Siem Reap - Talaborivath (NR66)	305.2				38.8	266.38
			Talaborivath - O Pongmoan (NR7)	19.0				19	
			O Pongmoan - O Yadav border (NR78)	187.7			68.2		119.5
			Sub-total Length (km)	511.9			68.2	57.8	385.9
Grand total length (km)				2,129.4			581.1	1,162.4	385.9

Source: MPWT

Note: International road classifications are as follows (ASEAN STANDARD):
 [Primary] Roads used exclusively by automobiles/AC or concrete pavement
 [Class I] Highways with 4 or more lanes/AC or concrete pavement
 [Class II] Roads with 2 or more lanes/AC or concrete pavement
 [Class III] Narrow 2-lane roads/DBST pavement

Table 1-5 illustrates the total population compared to the total road length and people living in rural area to the rural road length.

Table 1-5: Population by Road Density

Road Network:		
o 1-digit NR:	2,117	km
o 2-digit NR:	3,146	km
o Provincial Road:	6,441	km
o National and Provincial Road (L1):	11,704	km
o Rural Road (L2):	33,005	km
o Total Road length (L=L1+L2):	44,709	km
Land areas (S)	181,035	sq.km
Population in 2009 (Population in 2008 x 1.54%)		
o Total population (P=P1 + P2):	13,595,089	Person
o Rural population (P1):	10,944,045	Person
o Urban population (P2):	2,651,044	Person
o PxS	2,461,186,947,977	Person.sq.km
o (PxS) ^{0.5}	1,568,817	Person.sq.km
Road density and Road density index		
Road Density, RD = L/S (km/sq.km)		
o All roads:	0.247	km/sq.m
o National & Provincial roads:	0.065	km/sq.m
o Rural roads:	0.182	km/sq.m
Road Density Index, RDI=L/(PxS) ^{0.5}		
o All road:	0.028	km/(person.sq.km)
o National & Provincial roads:	0.007	km/(person.sq.km)
o Rural roads:	0.021	km/(person.sq.km)
Total population/Total road length	304.079	Person/km
Rural population/Rural road length	331.587	Person/km

Source: World Bank (Updated by MPWT)

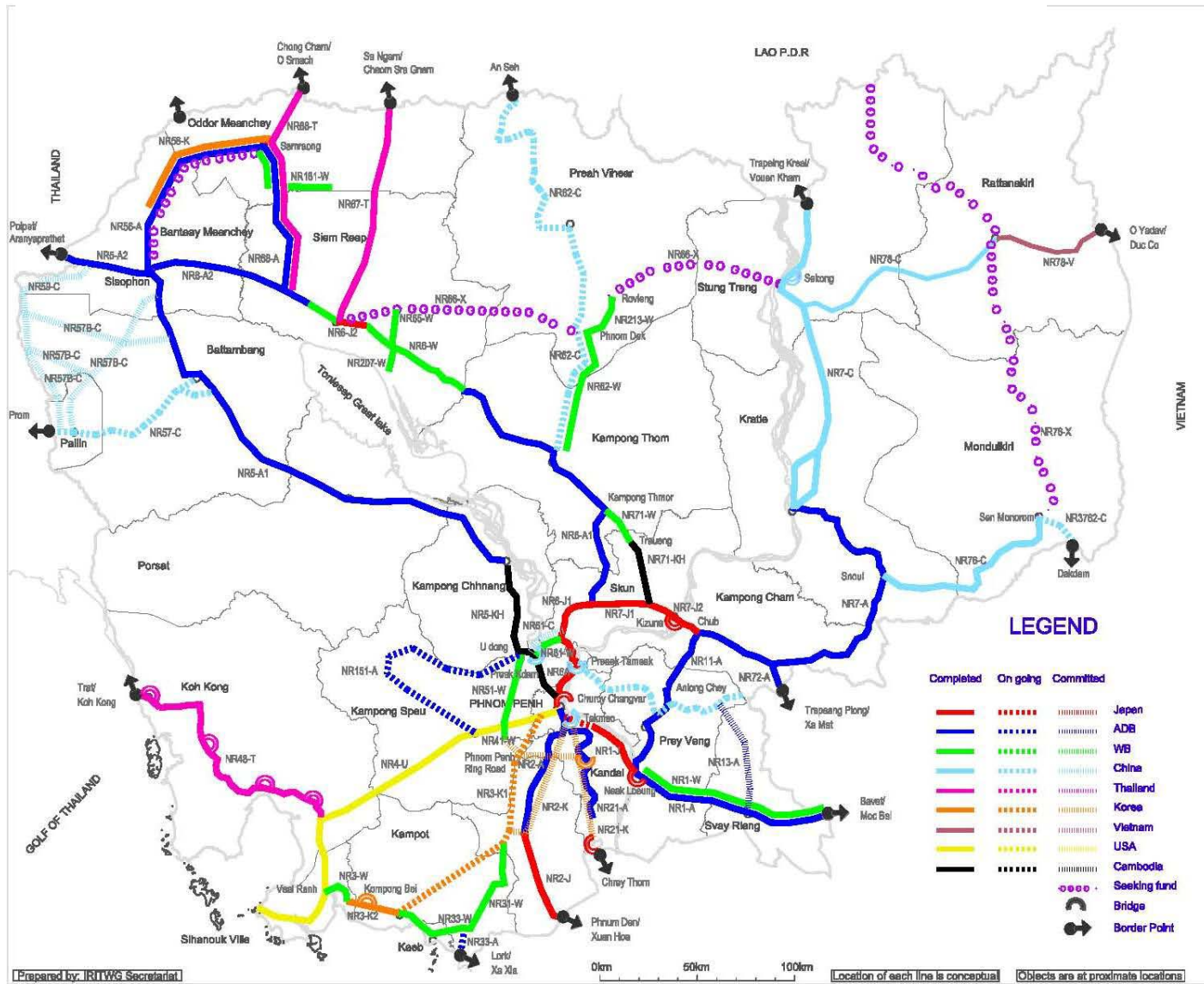

Source: MPWT

Figure 1-8: Road and Bridge in Cambodia

Overview on Transport Infrastructure Sectors in the Kingdom of Cambodia (March 2010, IRITWG)

Major Road Improvement Projects in Cambodia

No.	Org.	Cost (Mill\$)	length (km)	Section	Year		Fund	Status
					Start	End		
1	Japan	80.00	56.0	Phnom Penh - Neak Loeung	2005	-	Grant	AC (2010: Korki to Neak Loeung)
	ADB	50.00	107.0	Neak Loeung - Bavet	1999	2004	Loan	DBST
	WB	3.00	107.0	Neak Loeung - Bavet	2009	2013	Loan	Road Maintenance (Upgrading)
2	ADB	-	63.0	Kbal Thnal - Takeo	2001		Loan	DBST
	Korea	-	63.0	Kbal Thnal - Takeo	-	-	-	-
	Korea	-	-	Takeo - Ang Tasaom (NR3)	-	-	-	DBST
	Japan	12.50	51.7	Takeo - Phnum Den	2003	2007	Grant	AC
3	Korea	36.90	137.5	Chom Chao - Kampot	2008	2010	Loan	DBST
	Korea	17.05	32.7	Kampot - Trapang Ropaou	2004	2008	Loan	DBST
	WB	47.60	32.5	Trapang Ropaou - Veal Renh	1999	2006	Loan	DBST
4	USA	50.50	217.0	Chaom Chao - Sihanouk Ville		1996		AC
	AZ		217.0	Chaom Chao - Sihanouk Ville	2001	2035	OT	Operate transfer (periodic maintenance)
5	Cambodia		91.0	Phnom Penh - Kampong Chhnang		2003	Treasury	DBST
	ADB	>1	85.0	PK:6+00 - Kampong Chhnang	2010	2011	Loan	Maintenance
	ADB	68.00	261.0	Kampong Chhnang - Sisophon	2000	2004	Loan	DBST
	ADB	77.50	48.0	Sisophon - Poipet	2006	2008	Loan	AC
6	Japan	28.00	44.0	Phnom Penh - Chealea	1993	1995	Grant	AC (deteriorated condition)
	Japan			Chealea - Cheung Prey	1996	1999	Grant	AC (deteriorated condition)
	ADB		112.0	Cheung Prey -	2000	2004	Loan	
	WB	16.10	73.0	Kampong Thom - Ro Lous	1999	2006	Loan	DBST
	Japan	12.00	15.0	Siem Reap - Bakong temple	2000	2001	Grant	AC
	ADB		100.0	Sisophon - Siem Reap	2006	2008	Loan	AC
7	Japan			Cheung Rey - Kompong Cham	1996	1999	Grant	AC
	Japan	19.00		Kompong Cham - Chob	2001	2003	Grant	AC
	ADB		205.0	Chob - Kratie	2000	2004	Loan	DBST
	China	62.80	192.8	Kratie - Trapeang Kriel	2004	2007	Loan	DBST
8	China	71.50	109.0	Preak Ta Mak - Anlong Chrey	2007	2010	Loan	AC
	China	14.80	14.8	Anlong Chrey - Krek	-	-	Loan	-
	China	14.80	14.6	Krek - Moeun Chey	-	-	Loan	-
11	ADB	-	90.4		2001	2004	Loan	DBST
	Korea			Bridges				Combined with NR21
13	ADB	-	-	Svay Rieng - Anlong Chey	-	-	-	-
21	ADB	-	77.5		2002	2004	Loan	DBST
	VN		0.4	Chhrey Thom			Loan	Bridge (50%-50% share with RGC)
	Korea	57.00	25.0		2010			(Including bridge at NR11)
31	WB	12.90	51.7		2003	2005	Loan	DBST
33	WB		39.8	Takeo - Kampong Trach - Kampot	2002	2005	Loan	
	ADB	13.00	17.0	Kompong Trach - Lork (Vietnam border)	2007	2010	Loan	DBST
41	WB			National Road 4 - Prek Thnout River	-	-	Loan	DBST
44 + 151	ADB	-	124.0	Kg. Speu town - Oral - U dong	-	-	Loan	DBST
48	Thai	21.69	151.3	Koh Kong - Sre Ambel	2004	2007	Loan	DBST
	Thai	7.20	1.6				Grant	4 Bridges
51	WB	5.80	38.9	Udong - Thnal Torteng	2003	2006	Loan	DBST
56	Seeking	-	115.0	Sisophon - Samrong	-	-	-	Road only not structure
	Korea	29.90	84.0	29km from Sisophon to Samrong	-	2009	-	Road improvement
56-68	ADB	12.50	185.0	Sisophon - Smarong - Kralanh	2005	2007	Loan	Structure only
57	China	41.80	103.0	Batambang - Thai Border	2008	2011	Loan	DBST
57B	Private	34.00	163.0	Tmor Kol - Bovel - Sampov Luun	-	-	BOT	-
	China	\$ 176.40	90.0	Tmor Kol - Bovel - Sampov Luun	-	-	Loan	-
59	China	72.90	144.3	National Road 59 (Koun Damrey - Malay - Sampov Luun)	2010	-	Loan	AC
5x	Private	5.50	13.0	National Road 5 - Thai border (through Chay Chay investment)	2004	-	-	DBST (not yet started)
61	WB		16.0	Thnal Keng - Prek Kdam	2002	2005	Loan	Maintenance
	China	9.80	16.0	Thnal Keng - Prek Kdam	-	-	Loan	AC (not yet started)
62	WB	-	-	K.P. Thum - Provincial border	2005	-	Loan	Laterite (Not compelet)
	Seeking	-	-	Provincial border - Meanchey	-	-	-	-
	China	57.80	157.0	Meanchey - Preah Vihear	2008	2011	Loan	DBST
	China	52.00	128.0	Kampong thom - Tbaeng Meanchey	2008	2011	Loan	DBST

65	WB	-	-	Dam Dek -	2005	-	Loan	DBST
	WB	1.40	18.5	Phnom Dek - Rovieng	2004	2006	Loan	DBST
66	WB	3.20	18	Rovieng - River Stung Sen			Loan	DBST (not yet started)
67	Thai	3.06	18.0	Choam Sa Ngam - Anlong Veng	2006	2007	Grant	DBST
	Thai	32.50	131.0	Anlong Veng - Siem Reap	2006	2009	Loan	DBST
68	Thai	35.00	113.0	O Smach - Kralagn	2007	2009	Loan	DBST
71	Cambodia	-	-	Chomkarleu - Kampong Cham	-	-	-	-
	WB	1.50	15.5	Traueng (NR7) - Kampong Thmar (NR6)	2004	2006	Loan	DBST
72	ADB		14.0		2007	2009	Loan	
76	China	51.90	127.0	Snoul - Sen Monorom	2007	2010	Loan	DBST
78	VN	25.80	70.0	Bang Lung - O Yadav	2007	2008	Loan	AC
	China	73.30	123.1	O Pong Moan - Bang Lung	-	-	Loan	DBST
78x	Private	6.00	36.0	Ban Lung - Bou Sra (waterfall)	2008	-	-	DBST (not yet started)
181	WB	2.00	28	Samraong - Chong Kal	2004	2006	Loan	DBST
207	WB	1.00	1	Sautr Nikom - Beong Tonle Sap	2004	2006	Loan	DBST
210	Private	21.50	-	Siem Reap - Koh Ke	2003	-	BOT	DBST
Prek Phnov	Private	42.00	8.17	Phnom Penh (Prek Phnov) - NR6A		2010	BOT	DBST (Including bridge cost)

Name of Bridge	Donor	Cost	length	Location	Year		Fund
		(Mills)	(km)		Start	End	
Kizuna	Japan	\$60.00	1.3	Kompong Cham, NR7	1996	2001	Grant
Churoy Changvar	Japan	\$27.00	-	Phnom Penh, NR6A	1992	1993	Grant
Neak Loeung	Japan	\$134.00	2.2	Kandal, Svay Rieng, NR1	2011	2015	Grant
Preaek Ta Meak	China	\$43.50	1.1	Prey Veng, NR8 & NR6A	2007	2011	Loan
Preaek Kdam	China	\$28.90	1.0	Phnom Penh, NR5 & NR61	2007	2011	Loan
Kompong Bai	Korea		0.3	Kampot, as a part of NR3	2005	2007	Loan
Se Kong	China		-	Stoeng Treng, as a part of NR7	2005	2008	Loan
Koh Kong	Private	\$7.00		Koh Kong, NR48	2001		BOT
Stung Meanchey	Private	\$5.00		Phnom Penh - Chaom Chao	1999		BOT
New 2nd Churoy Changvar	Private	\$89.87		Phnom Penh - NR6A	-	-	BOT
Prek Phnov	Private	\$42.00	1.543	Phnom Penh - NR6A	-	2010	BOT
Tek Thla	-	-	-	Phnom Penh (along NR3)	2009	2010	-

1.6. Present State of Road Traffic

The number of registered automobiles has been increasing at a rate of about 19% each year, and has reached almost 1,400,000 automobiles in 2009 (accounted about 82% of all registered automobiles).

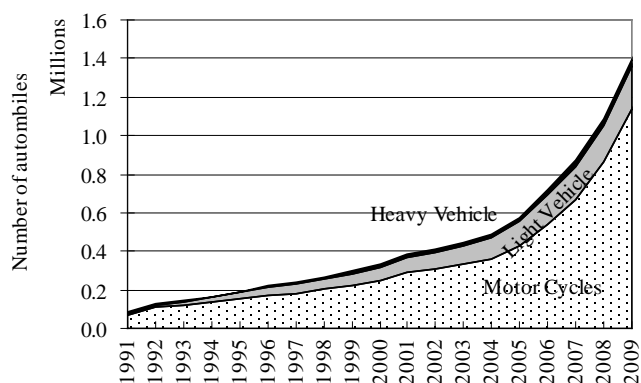
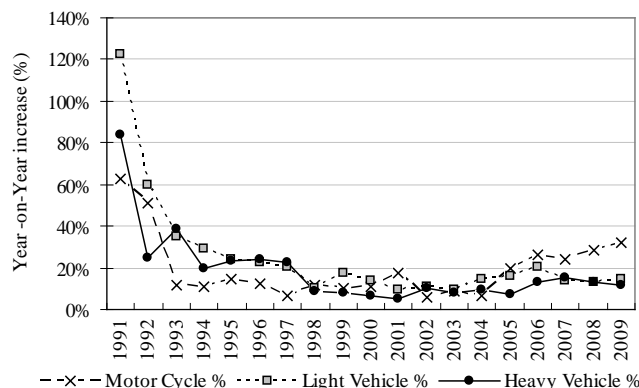

Figure 1-9: Number of registered automobiles



Source: MPWT

Figure 1-10: Year-on-year increase in number of registered automobiles

1.7. Road Maintenance

The routine maintenance budget for 2009 was 35% increase from the previous year, in contrast periodic maintenance budget for 2009 was 11% decreased. In general, road maintenance budget for 2009 was 13% higher compare to the budget in 2008.

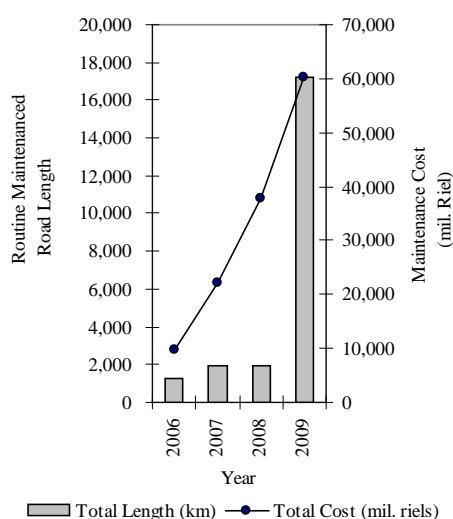

Source: MPWT

Figure 1-11: Trends in routine maintenance programs

Table 1-6: Road Maintenance Budget for 2009

No	Type of Maintenance	2009	
		Length, km	Budget Allocated
1	Routine Maintenance	17,203	60,185 Million Riels
	1.1 Regular Inspection	13,821	203 Million Riels
	1.2 A/C road	2,350	51,306 Million Riels
	1.3 Laterite road	992	
	1.4 Routine Bridge Maintenance (concrete bridge, wooden, steel)	25,052	1,343 Million Riels
	1.5 Culvert maintenance (All type)	2,435	284 Million Riels
	1.6 Channel works	12,235	7,049 Million Riels
2	Periodic maintenance³	168,324	57,000 Million Riels
	2.1 A/C road	4.2	
	2.2 DBST road	62	
	2.3 Macadam road	21	
	2.4 Laterite road	81	
	2.5 Reinforced Bridge	0.124	
	2.6 Culvert	42 places	
3	Emergency		Budget: 10,000 Million Riels Spent: 5,254 Million Riels
	3.1 A/C	5 sections	
	3.2 Laterite	17 sections	
	3.3 Wooden bridge (repair)	7 bridges	
	3.4 Baley Bridge (repair)	36 Bridges	
	3.5 Culvert (repair)	12,200 m	

Source: MPWT

In 2010, maintenance budget will be increased from 136.5 Bill Riels in 2009 to 150 Bill. Riels (10% increased). This budget will be allocated for the maintenance of the following structures:

Table 1-7: Road maintenance budget for 2010

Description	Length	Cost	Remark
1. Routine Maintenance		74,570 Million Riels	
1.1 National and provincial road (A/C)	2,6824 km	32,737 Million Riels	One or two digits
1.2 National and provincial road (Laterite)	1,211 km	24,866 Million Riels	One or two digits (excluding National Road 68)
1.3 Traffic inspection		304 Million Riels	
1.4 Culvert construction at key infrastructure	24.325 km	16,663 Million Riels	
2. Periodic Maintenance	35 projects	63,000 Million Riels	MPWT and Ministry of Economy and Finance agreed that from year 2011: - Provide high priority on periodic maintenance on existing structure - Provide Very low priority on a) road-width expansion, b) upgrade from laterite to A/C
3. Emergency maintenance		12,000 Million Riels	
	Total	150,000 Million Riels	Exchange rate 1USD=4,200 Riels (as of March 2010)

Source: MPWT

1.8. Road Safety

While the number of all type of automobiles is increasing, the number of road accidents is also increasing. In average, per day in 2009, there were 34.4 accident cases, out of which 4.7 persons were killed and 54.3 injured. In comparison, there were 12.3 and 12.6 fatalities per 10,000 registered automobiles and 100,000 populations (far above the road accident target set by ASEAN)⁵, respectively.

³ 33 projects had been planned for 2009. By 16th Dec. 2009, 90% of them had been achieved.

⁴ 332 km longer than those in 2009.

⁵ Road accident target in ASEAN by 2010 is 07 fatalities per 10,000 vehicles.

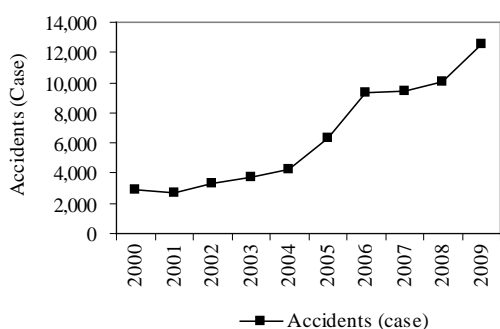

Source: Cambodia Road Traffic Accident and Victim Information System Semester Report 2009⁶

Figure 1-12: Trends in traffic accidents (case) in Cambodia

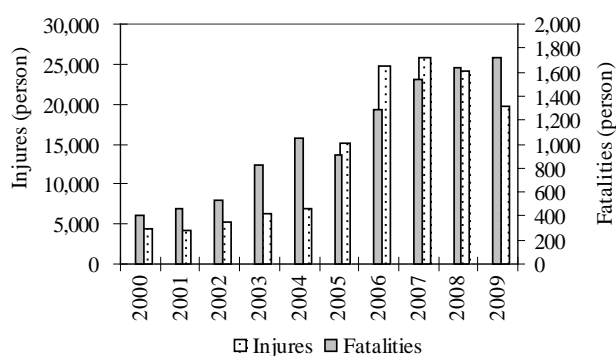
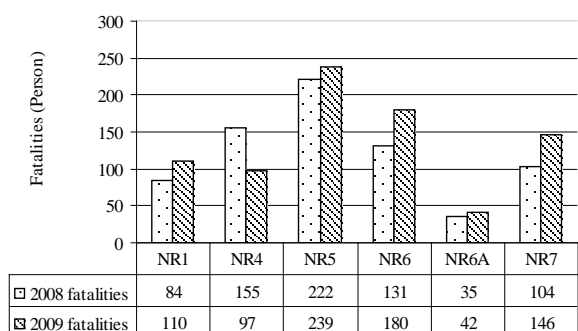

Figure 1-13: Trends in traffic injuries & fatalities in Cambodia

Asian Highways: 47% of fatalities occurred along the ASEAN highway network in 2009. Compared to 2008, the number of fatalities increased almost on all road networks except NR4 (from 155 fatalities to 97 fatalities). The highest fatality rate was observed on national road number 5 (239 fatalities in 2009). More than 90% of the accidents were caused by human errors (see Table 1-8).



Source: Cambodia Road Traffic Accident and Victim Information System Monthly Report 2008 & 2009

Figure 1-14: Fatalities in Asian Highway in 2008 & 2009

Table 1-8: Causes of traffic accident in 2009

	Human Error	Road Environment	Vehicle	All factors
Human Error	94.94%	0.92%	0.81%	0.34%
Road Environment	0.92%	1.07%	0.02%	
Vehicle	0.81%	0.02%	2.29%	
All 3 factors	0.34%			-

Source: HIB, MPWT

Important noticed factors observed in traffic accident (and need to be improved):

1. Land traffic implementing officers do not permanent implement their jobs
2. Road user do not wear helmet 100%
3. Over speed limit is still the main problem
4. Some vehicles do not register correctly, use fake number tag, fake document, and do not have registration document that issued by vehicle number tag company (article 91)
5. Vehicles without number tag and ID card or other permission documents always detour their trip from police officers that some time cause accident (article 79 of traffic law).
6. There are overlapping motorcycle registration in Phnom Penh and provinces.
7. Sometime overload is also a cause of accident
8. Modified vehicle can also cause accident and damages road infrastructure
9. Some vehicle did not have technical check and use fake document, which further abet the management problem

Corrective action taken by the Royal Government of Cambodia through national committee for land traffic safety:

1) Tactical approach

1. Traffic safety education via advertisement (supported by ADB, AUSAID, and WHO)
2. Establishment of helmet standard in Cambodia
3. Prepared traffic accident victims information system
4. Strengthen vehicle registration and technical check
5. Train drivers
6. Try to respond to the emergency aid
7. Manage and coordinate land traffic safety
8. Celebrate land traffic safety's week every early April every year

⁶ This figure is obtained from yearly report, which is subjected to increase upon the publication of 2009 yearly report.

2) Strategic approach

With cooperation of ADB, Ministry of interior and the Ministry of Public Works and Transport had proposed 15 action plans, which had been approved by Prime Minister:

1. Creation National Road Safety Committee.
2. Road Accident Data Systems.
3. Road Safety Funding.
4. Road Safety Audit and Hazardous Locations.
5. Road Environment and Road Design.
6. Road Safety Education for Children.
7. Traffic Law and Regulations.
8. Law Enforcement.
9. Technical Inspection.
10. Drivers Training.
11. Emergency Assistance to Traffic Victims.
12. Road Safety Public Campaigns.
13. Partnerships with Private and NGOs.
14. Road Accident Costing Evaluation.
15. Road Safety Research Institution.

3) National Target

It is estimated that unless additional actions are taken, the number of fatalities in Cambodia will increase every year up to 3,200 by 2020⁷. Therefore, the Royal Government of Cambodia has committed to **reducing the number of road fatalities in 2020 by 30%** (or reducing to 2,240 fatalities) (Figure 1-15).

- National Target 1: To reduce number of fatality by 30% by 2020;
- National Target 2: To reduce fatality rate (against 10,000 registered vehicles) by 30% by 2020.

When this target is achieved, it will result in 4,700 lives saved over 10 years.

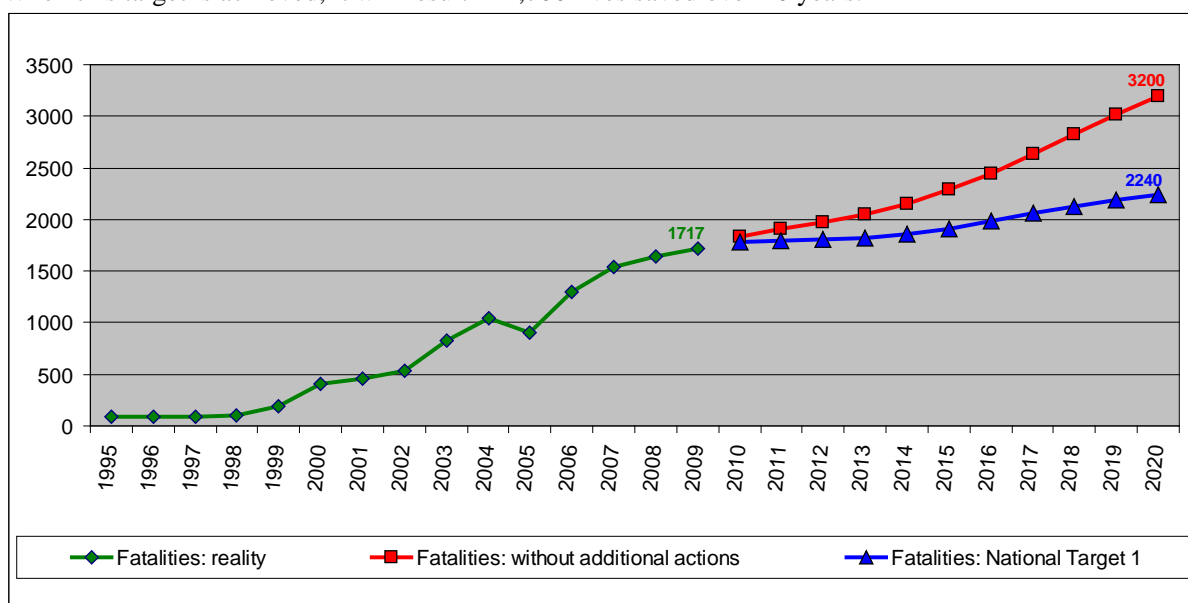

Source: MPWT

Figure 1-15: Estimated number of fatalities in Cambodia 2010-2020

To achieve the above plan, a total of \$108.738 Million is required:

Table 1-9: Budget required to achieve the plan (x\$1,000)

Action	Year	2011	2012	2013	2014	2015	2016	2017	2018	2019	2020	Total
Action Plan 1: Road Safety Management		316	764	332	354	332	430	452	430	430	452	4,292
Action Plan 2: Infrastructure		1,125	1,125	1,205	1,125	1,085	1,165	1,085	1,085	1,165	1,085	11,250
Action Plan 3: Safe Vehicles		820	820	520	520	520	445	445	450	450	450	5,440
Action Plan 4: Safe road user behaviour		1,240	1,750	2,140	2,080	2,583	2,583	2,583	2,583	2,583	2,583	22,708
Action Plan 5: Post Crash Care		1,630	1,440	1,440	1,540	1,723	1,903	1,903	1,903	1,903	1,903	17,288
Action Plan 6: Traffic Law Legislation and Enforcement		3,640	3,310	3,310	3,640	4,335	4,335	4,775	4,335	4,335	4,775	40,790
Action Plan 7: Driver's Licensing		332	362	332	332	372	440	440	440	440	3,480	6,970
Total Budget		9,103	9,571	9,279	9,591	10,950	11,301	11,683	11,226	11,306	14,728	108,738

Source: MPWT

⁷ Number of vehicles is estimated to be increased by 4 Millions in 2020 (compared to 2009)

1.9. Overload transport

A major factor to destroy road condition had been observed to be caused by overload transport. To tackle this problem, 3 levels of management had been established:

- Level 1: Leading committee of overload control
- Level 2: Permanent coordinating committee whose role and responsibilities are:
 - Organize general controller at 7 weigh station and increase works shift
 - Train and build the officers capacity
 - Seeking supporting fund from development partner and national fund package
 - Prepare implementing plan to manage overload control

The task to manage overload control faces many difficulties:

- Lack of weigh station in on all National Road and provinces
- Lack of budget to enforce truck not to put off their goods before arriving at the weigh station
- Lack of mobility to travel from one place to monitor at another place
- Having limited cooperation from authority
- Having poor cooperation from truck driver
- In rainy season, cannot enforce the truck to stop and weight.
- Level 3: Weigh station unit to be established and the structure is installed at key strategic locations through the Kingdom of Cambodia (see Figure 1-15). The location of weight station are:

Table 1-10: Locations of weight station in Cambodia

Item	NR	Location name (Province)	PK (approx)	Existing	Proposal
1	1	Kien Svay (Kandal)	025+000		✓
2	1	Takouk-Lovea (Prey Veng)	076+900		✓
3	1	Bavet (Svay Rieng)	194+100	✓	
4	2	Thnal Dei Krohom (Kandal)	020+300		✓
5	2	Roka Knong (Takeo)	074+300		✓
6	3	Sre Ronoug (Takeo)	080+000		✓
7	3	Trapaing Ropeou (Kampot)	179+000		✓
8	5	Lung Vek (Kampong Chhnang)	048+000	✓	
9	5	Kleang Moeung (Pursat)	191+800	✓	
10	5	Anlung Vil (Battambang)	282+000		✓
11	5	Koun Domrei (B. Meanchey)	389+000	✓	
12	6	Pourk (Siem Reap)	331+840	✓	
13	6	Svay Kal (Kampong Thom)	147+000		✓
14	6	Thal Keng (Kampong Cham)	046+300	✓	
15	7	Thnal Totung (Kampong Cham)	137+000	✓	✓
17	21	Chhung Leap (kandal)	031+000		✓
Total		17 Locations		07	10

Source: MPWT

LOCATION MAP OF WEIGH STATIONS

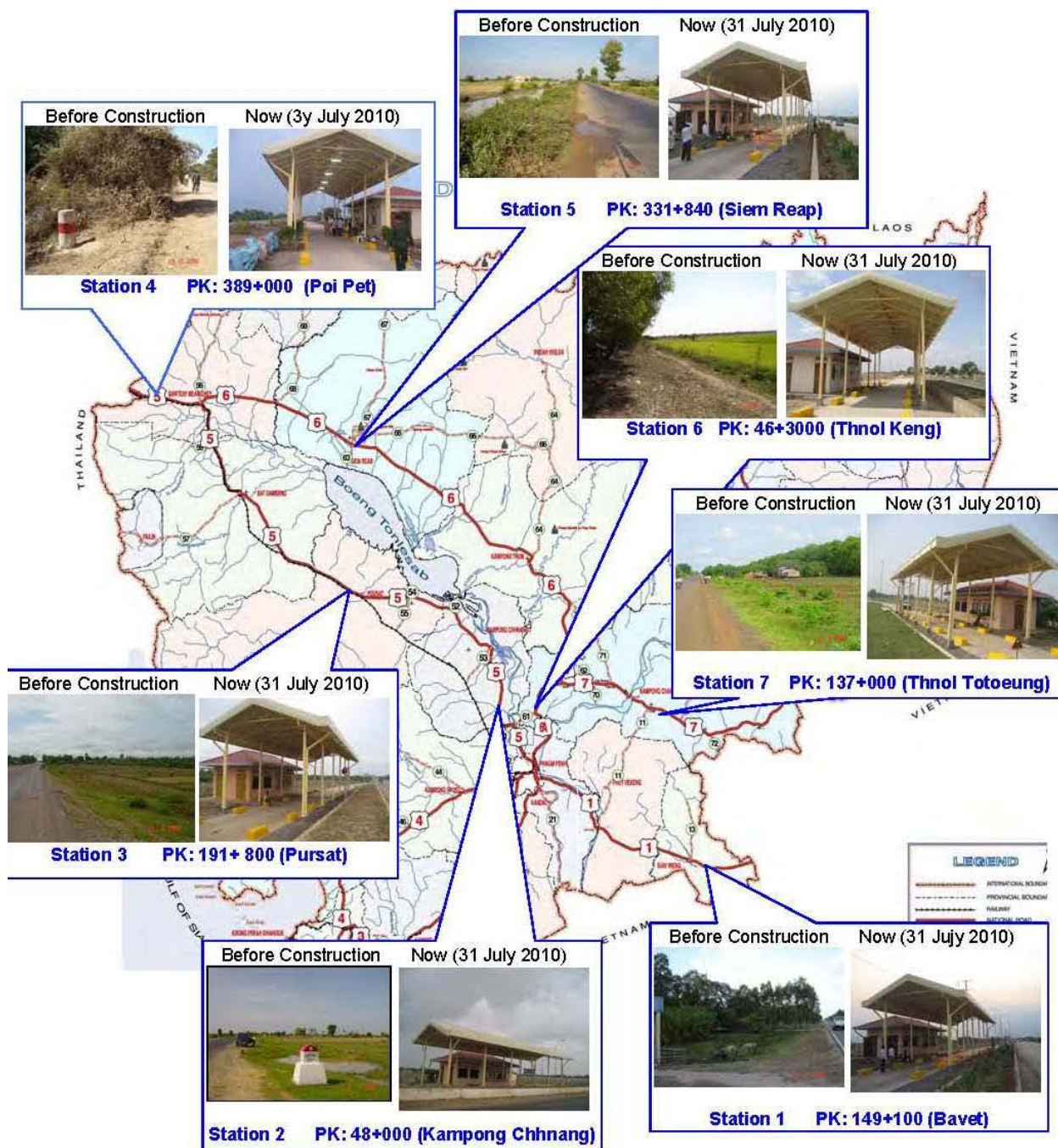

Figure 1-16: Location maps of weigh stations

Source: MPWT

1.10.Future Road Development

To further strengthen the flow of the traffic and improve the economic development, the Royal Government of Cambodia has adopted 6 keys strategies dealing with road sector:

- Strategy I: Strengthen and improve the multi growth poles⁸ development
 - Completed projects:
 - Enlarge NR 6 to 4 lanes: Phnom Penh-Th’Nal Kaeng
 - Enlarge NR 5 to 4 lanes: Phnom Penh-Prek Phnau
 - Enlarge NR 4 to 4 lanes: Phnom Penh-Sihanouk Ville

⁸ Multi-growth poles development areas are: Phnom Penh, Sihanouk Ville, Svay Rieng, Kampong Cham, Stung Treng, Ratanakiri, Siem Reap, Poi Pet and Battambang provinces.

- Future projects:
 - Upgrade road and try to enlarge them to 4 lanes to connect to potential development poles
 - Improve the road network in development pole
 - Detouring road and sky bridge to solve traffic congestion at development poles
 - Construct express way Phnom Penh-Sihanouk Ville
 - Construct high way Phnom Penh-Chrey Thom
 - Construct express way Phnom Penh-Siem Reap-Poi Pet
- Detouring roads and ring roads at important cities:
 - Construct detouring road, Siem Reap
 - Construct detouring road, Battambang
 - Construct ring road of Phnom Penh
 - Construct detouring road, Kampong Chhnang
- Strategy II: Strengthen and improve road network to serve important social economic development region
 - Enlarge NR 4 and NR 1 to 4 lanes
 - Construct second Neak Loeng Bridge
 - Prepare plan and develop road network connecting to NR 4 and NR 1
 - Improve quality and traffic safety of economic development corridor road
- Strategy III: Push the development of tourism
 - Enhance road in tourism region in order to offer convenient, good environment, create opportunity to public
 - Establish administrative office at international gates to offer tourists convenient, enhance the connecting road
 - Construct convenient airport, upgrade and enhance the connecting road
 - Construct tourist port, upgrade and enhance the connecting road
 - Construct sewage treatment station

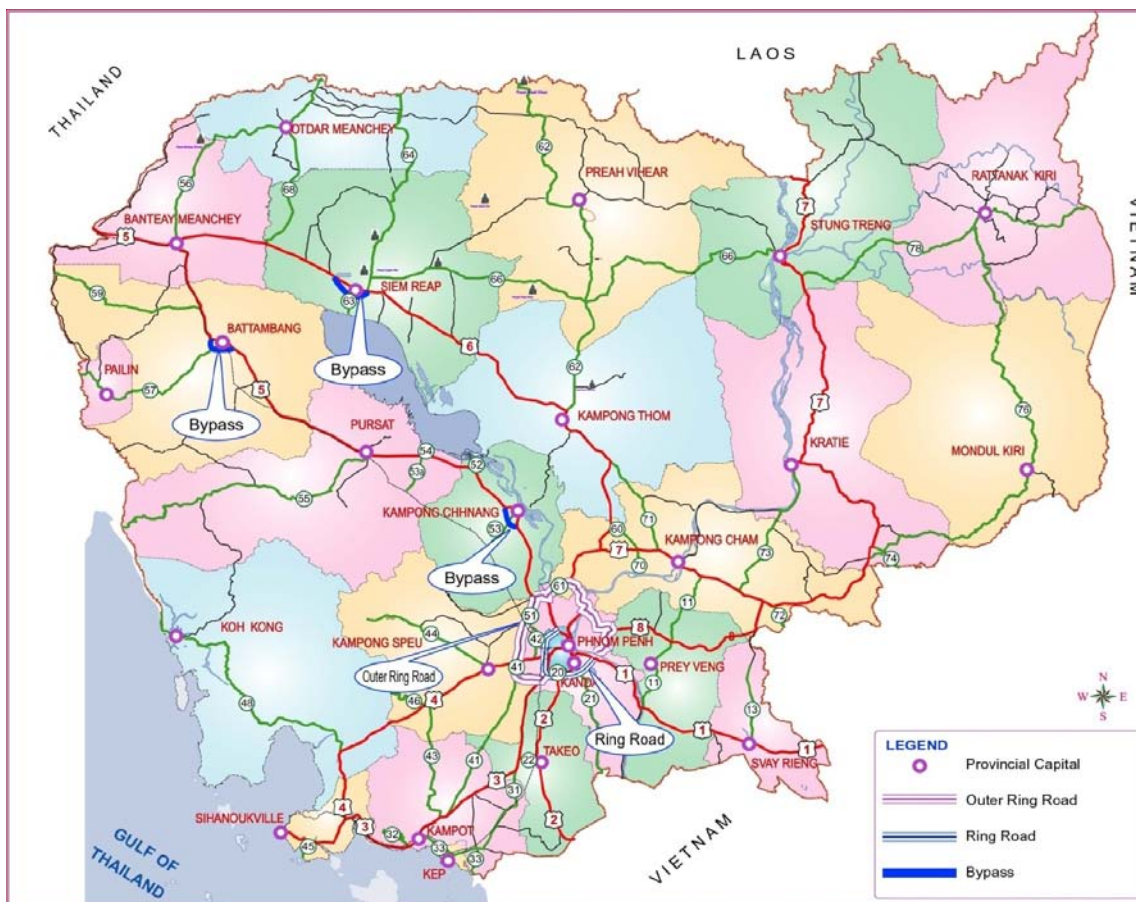

Source: MPWT

Figure 1-17: Bypass and Ring Road Development

- Strategy IV: National and regional integration
 - Construct and upgrade national road 1 and 2 digit
 - Construct and upgrade provincial road 3 digit (inter-provincial road) and in province road
 - Construct and upgrade district road
 - Construct and upgrade rural road
- Strategy V: Develop international corridor
 - Develop international corridor (1) GMS International Highway
 - Strengthen the function of national road 1 digit and enhance national road 2 digits that defined to be GMS highway
 - Construct nation-wide road connecting to all international gates:
 - i. Vietnam: NR33, NR2, NR21, NR1, NR8, NR72, NR74, NR3762 and NR78
 - ii. Lao P.D.R: NR7
 - iii. Thailand: NR62, NR64, NR66, NR5, NR59, NR57, NR55 and NR58
 - iv. Others: NR4 (through Sihanouk Ville seaport)
- Strategy VI: Praise the development of social economy at rural and along border in order to reduce poverty
 - Strengthen national road 2 digits, provincial road 3 digits, road in province, district road connecting to rural area and road along border that have high agriculture, industry, and tourism potential
 - Construct road at triangle development (Cambodia, Lao P.D.R, Vietnam)
 - Construct road at emerald triangle development (Cambodia, Lao P.D.R ,Thai)

2. RAILWAY

2.1. Background

French Colonial Government in Cambodia built the first railway of 1 meter gauge linking Phnom Penh to Poi Pet (through Kampong Chhnang, Pursat, Battambang and Sisophon) on the Thai border in 1930s. This line is running across Cambodia's greatest rice producing province – Battambang. The Phnom Penh Railway Station inaugurated in 1932 whereas the connection with Thailand Railway was made in 1942, whose service later interrupted in late 1940s due to political and security reasons¹.

In 1960s in order to reduce the reliance on ports in then Australia², South Vietnam (Saigon) and Thailand (Khlong Toei), Cambodia, with support from France, West Germany and People's Republic of China, began to construct second 1 meter gauge railway line linking capital Phnom Penh to Sihanouk Ville port.

Rail service ceased during the civil war in 1970s and it started to provide limited service from 1980s despite limited funding, scarce resource, poor structure and security threat from the Khmer Rouge and other armed group. In compound with poor rail infrastructure and the improvement of road, bridge and the improvement of security (civil war ended in 1998), there was a decline of rail usage by the public particularly passenger service. It was declined over the year and regular service ended in 2009. Derailment of train in operation was not infrequent. Without adequate fund to maintain track, even though the new diesel-electric locomotive imported from China could not run due to dilapidated condition of the tracks.

To improve rail service in Cambodia, the government had awarded a contract to Toll Holdings to manage the rail service once the reconstruction of the tracks is completed. Both North and Southern line (links to Poi Pet and Sihanouk Ville respectively) will be re-opened in 2013.

2.2. Railway infrastructure

Railway in Cambodia consists of Northern, Southern and others lines:

1) Northern line

As built, the track on the Northern Line was laid with 30 kg/m rails on steel sleepers, and except where damage repairs have been carried out, the original track remains. The line has never been renewed and is designed for an axle load limit of only 10 tons. Most of the track is 60 years old or more, with the last 56 - at the western end being some 50 years old. There are 167 bridges on the line, of which 46 have suffered mine or other war damage, and received temporary repairs. The speeds are restricted to 5-10 km/h at 30 bridge sites.

2) Southern line

The Southern Line was built with 43 kg/m rails on untreated wooden sleepers. Due to only light traffic on the line since it was built, and the weight of the rails, the rails themselves are in very good condition. There are 94 bridges, of which 15 are badly damaged. These have received temporary repairs. The line was built to accommodate axle loads up to 20 tons, but in present conditions a limit of 15 tons is practical.

3) Other lines and facilities

There is a 6 km branch line from Phnom Penh, close to the station, to a port on the River Sap. It was intended for river-rail transshipment but this function had ceased. The branch line is still used by occasional freight trains that serve the oil terminal at Km 4.5 and the warehouses by the river at Km 6.

4) Stations

Stations are classified into three main types:

- 14 gares (main: stations), equipped with passing loops for the crossing of trains, and with sidings and/or other facilities for the handling of goods;
- 19 stations, with facilities for goods but no longer used for the crossing of trains;
- 3 halts, four of which are staffed. The halts are for passengers and luggage only.

¹ Thailand had been viewed to support anti-government movement: the Khmer Issarak

² Australia provided four 3rd class passenger carriages under Colombo plan.

2.3. Legal framework of railway management

The Establishment of Railway Department: Royal Government of Cambodia (RGC) issued sub-decree No. 163 dated 01st October 2009 to establish Railway Department. This department will be under the supervision and management of the Ministry of Public Works and Transport.

The Privatization of Railway: The 30-year concession to manage and upgrade Royal Cambodian Railways (RCR) has been awarded to the joint venture Toll Holdings, Australia (55 percent share) and the Royal Group (45 percent share). Revenues will be shared between the government and Toll when the railway becomes profitable. Toll will be responsible for upgrading and extending the network.

Table 2-1: Situation of Railway Facilities

Item	Northern Line (NL)	Southern Line (SL)
Length (km)	336km (to Sisophon) plus 48 missing links	264km
Section	Phnom Penh – Kampong Chhnang - Pursat - Battambang – Sisophon - Poipet	Takeo – Kampot – Sihanouk Ville
Station (number)	49 (Current Operation 7)	27 (Current operation 7)
Construction Year	1929 - 1942	1960 - 1969

Source: MPWT

2.4. Present State of Railway Use

Locomotive and Rolling stocks:

- Locomotives: 22 sets (8 are operating)
- Wagons: 248 sets

Train Service: Train service has begun to decrease in 2002. Northern and Southern Lines passenger service ceased operation in June 2008 and in 2009, averages of 0.4 freight trains per day were operated on both the Northern Line (NL) and the Southern Line (SL).

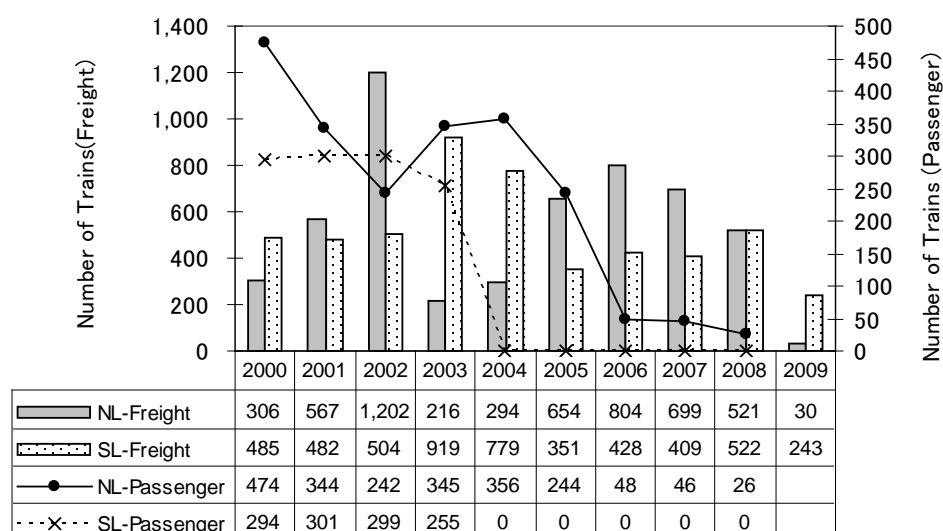

Source: MPWT

Figure 2-1: Number of trains operated in a year

The volume of rail cargo transport began to decrease after reaching 557,000 tons in 2002. The NL mainly carries cement, while the SL carries both cement and petroleum products.

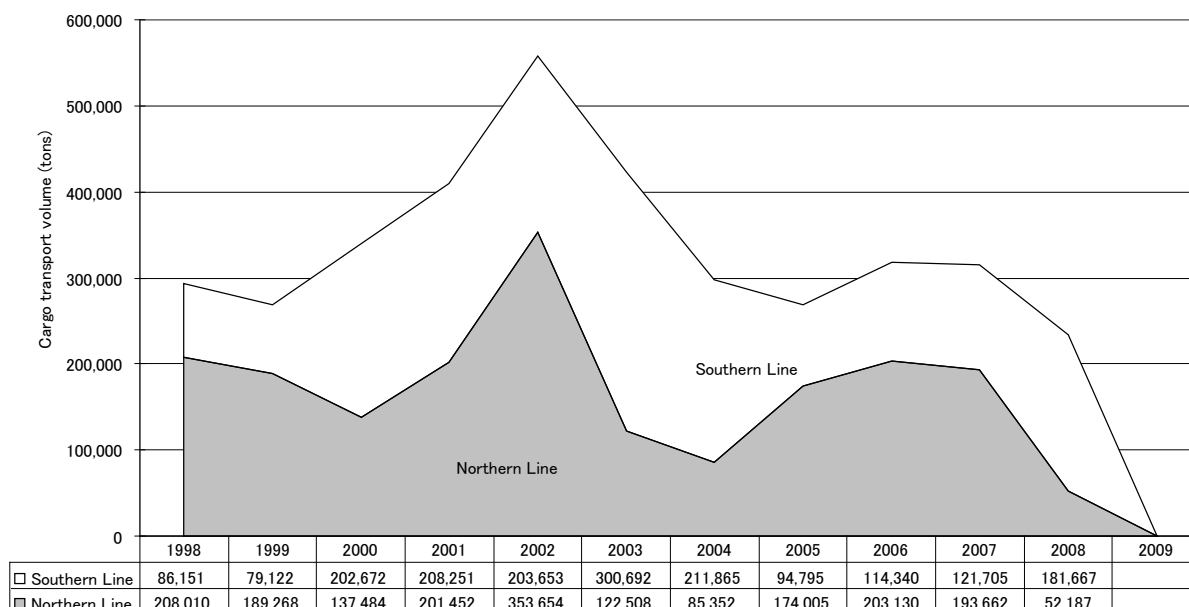

Source: MPWT

Figure 2-2: Trends in rail cargo transport volume

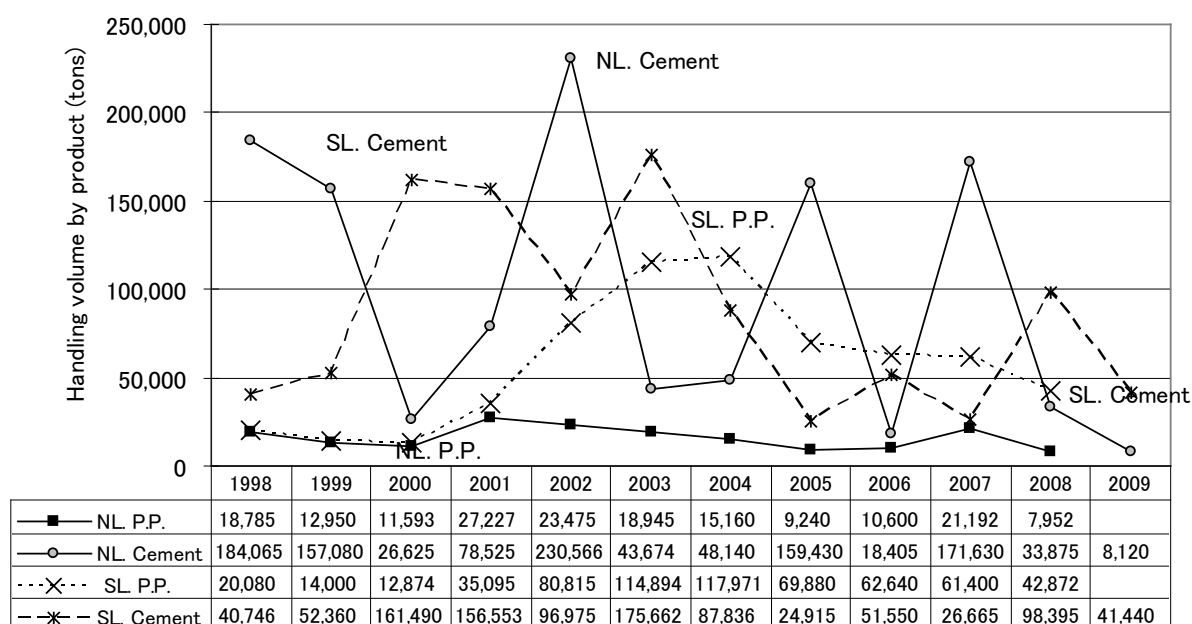

Source: MPWT

Figure 2-3: Trends in transport volume by product

The number of railway passengers has drastically decreased after 2000. The Southern Line has even terminated the operation of passenger trains in 2004. On the Northern Line, the number of round-trip services has been reduced from once a day to once a week, due to the decrease in the number of passengers. Today, a train composed of both cargo and passenger cars operate between Phnom Penh and Battambang.

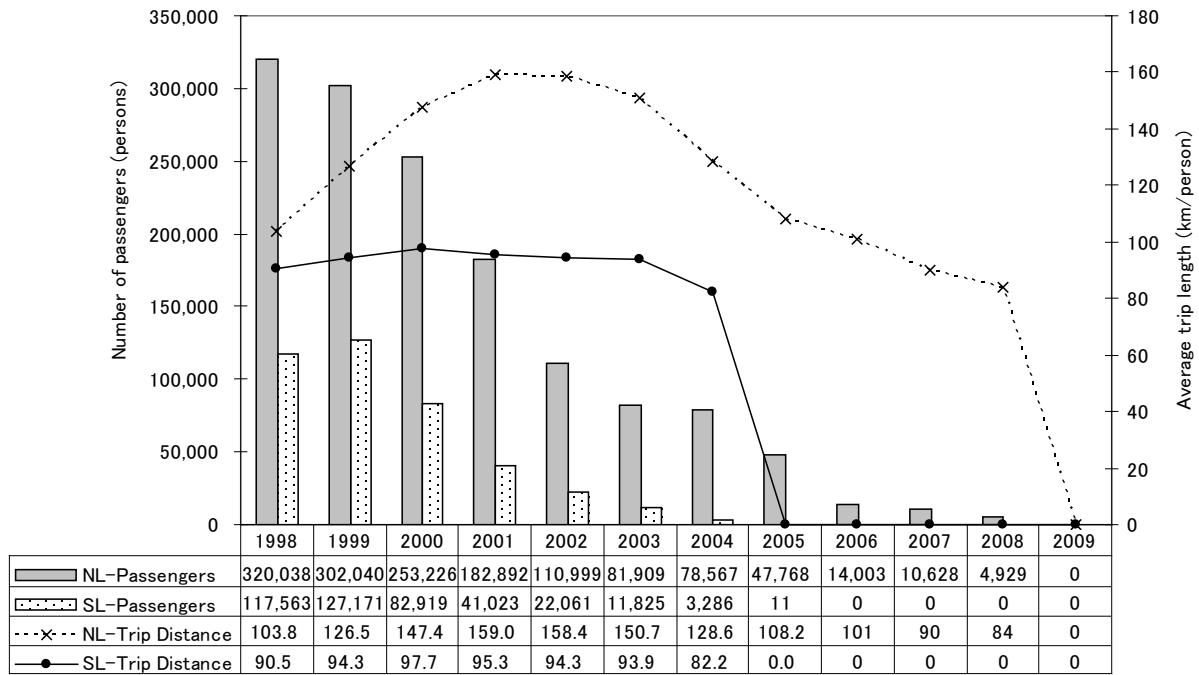

Source: MPWT

Figure 2-4: Trends in the number of railway passengers and the average length of their trips

2.5. Rehabilitation of Railway

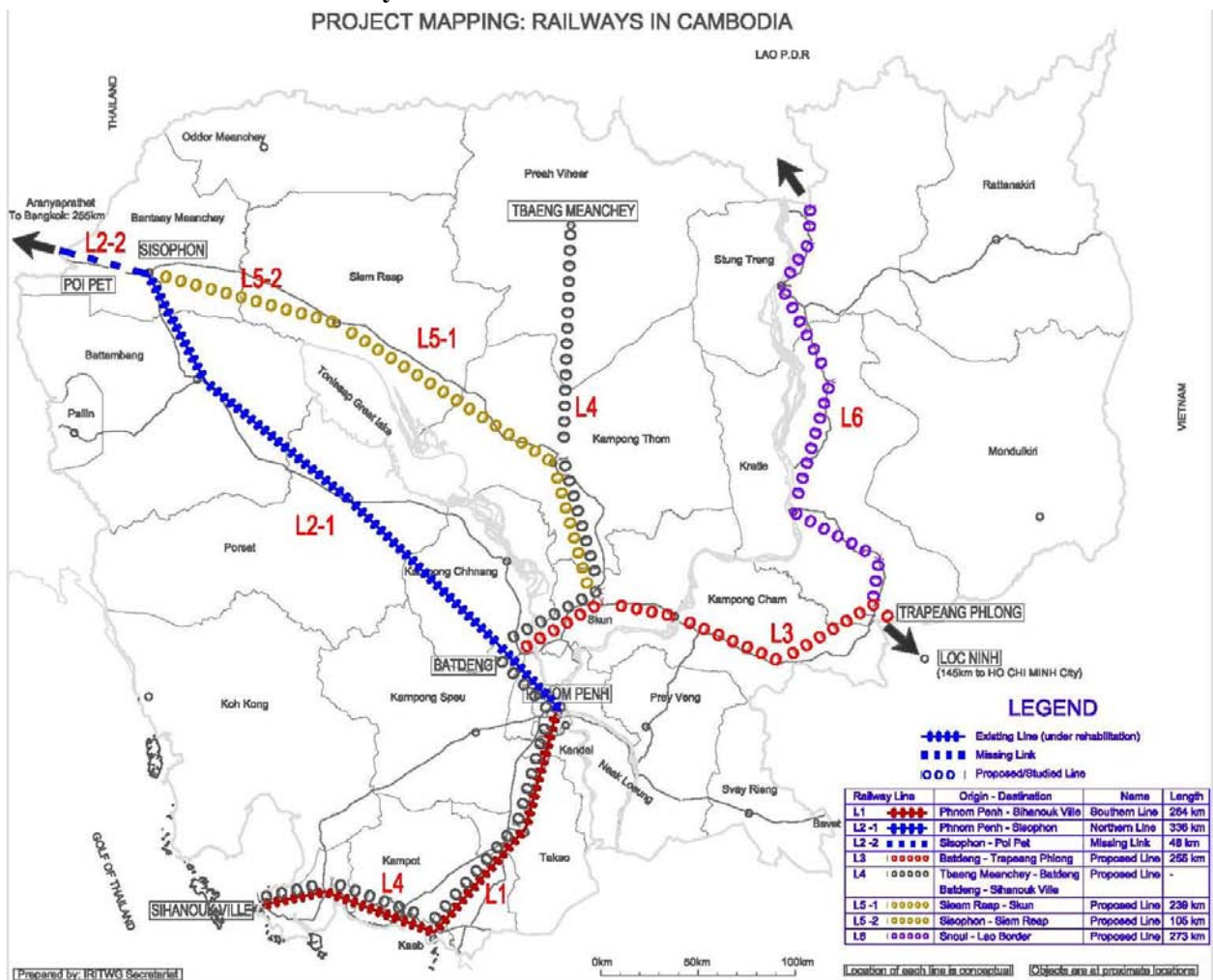

Source: MPWT

Figure 2-5: Cambodia Railways Network

Cambodia railway network is part of the Trans-Asia Rail Link, which also known as Singapore-Kunming Rail Link (SKRL), that run through countries such as Singapore, Malaysia, Thailand, Cambodia, Vietnam, Lao P.D.R and Myanmar before ending at Kunming in China. The link will be completed in 2015. To link with this network, Cambodia has to rehabilitated the existing railway system, fix the missing link and construct the newly proposed line from Batdeng to Loc Ninh, Vietnam.

The rehabilitation works, carried out by TSO, are separated into 3 packages:

- Missing link from Sisophon – Poi Pet (48 km): Reconstruction of the link to the border with Thailand, including earthwork, ballasting, track laying, station, and repairs to bridges and culverts (to be completed by end of 2012). The rail track will be donated by Malaysia and the construction work will be funded by ADB. Once the work is completed, it enable the movement of train from Singapore to Phnom Penh.
- Northern Line from Phnom Penh – Sisophon (336km): Rehabilitation and partial upgrade of the northern line, including embankment repairs, ballasting, providing, missing fittings, and replacement of track to improve the riding quality for a minimum operational speed of 50km/hour (to be completed by end of 2012).
- Southern Line from Phnom Penh – Sihanouk Ville (264km): Rehabilitation of Southern line, including repairs to embankments, renewal of track with concrete sleepers, rehabilitation of bridges and culverts (to be completed by end of 2012).
- For the 225-kilometer missing link between Phnom Penh and Loc Ninh, a border town between Cambodia and Vietnam, feasibility study on the missing link, funded and conducted by China, has been completed.

2.6. Future Development Plan

The Royal Government of Cambodia is also considering a supplementary financing arrangement with the ADB and a Grant from AusAID, which will provide funding for new station construction in Samrong (9km from Phnom Penh) and additional upgrading of the railway including branch line to Green Trade Warehouse (6km from Phnom Penh) and Northern line. According to the plan, the rehabilitation work will be completed in 2013:

- Updating and implementation of the resettlement plan for Samrong (to be completed in mid 2010)
- Design and construction of new freight facility in Samrong (to be completed in March 2013)
- Design and construction of the new spur lines to freight terminals in Phnom Penh (to be completed in March 2013).

Another railways line had also been envisioned:

- Tbaeng Meanchey (Preah Vihear) to Sihanouk Ville (through Kampong Thom, Skun, Batdeung and Phnom Penh). The primary purpose of this road is to export mine particularly iron ore from mineral rich province of Preah Vihear to the world through Sihanouk Ville port.
- Sisophon to Siem Reap. The total length of this line is 105km
- Siem Reap to Skun through Kampong Thom. The total length of this line is 239km
- Snuol to Lao P.D.R border through Kratie and Thalaborivat (Stung Treng) provinces. The total length of this line is 273km

3. Maritime and Ports

3.1. Background

During the period of the French Protectorate and earlier Cambodia, there was no deep water port to facilitate international trade. The small port on the river at Phnom Penh was only able to handle ships of up to 3,000 tons in the dry season and 4,000 tons in the wet season. Kampot was Cambodia’s only ocean port and deep-water access was impossible due to the need to navigate the Tuk Chhou River to access the port. The French colonial administration preferred to use Saigon (Ho Chi Minh) for international trade and thus Cambodia’s access to the ocean was via the Mekong and necessitated passage through Vietnamese territory. Independence from France for both Vietnam and Cambodia in 1953 highlighted the need for Cambodia’s own deep-water port.

A number of sites were initially considered for the new facility including – Kampot, the small outpost at Ream and Sre Ambel. However, the deep waters off a rocky promontory near Koh Pos in Kampong Som Bay were finally chosen as the site for Cambodia’s first ocean port. Construction began in 1955 with \$12 million in funding from the French government and was completed in late 1959. The port was inaugurated in April 1960 by Louis Jacquinot, the French Minister of State.

3.2. Present State of Ports

Among the ports in Cambodia, only Sihanouk Ville Port and Phnom Penh Port handle international container goes. Other ports besides the two autonomous ports are extremely small sea or river ports, such as Koh Kong port, Sre Ambel Port and Kampot Port, with the exclusion of the petroleum jetty in Sihanouk Ville city and Oknha Mong Port (private).

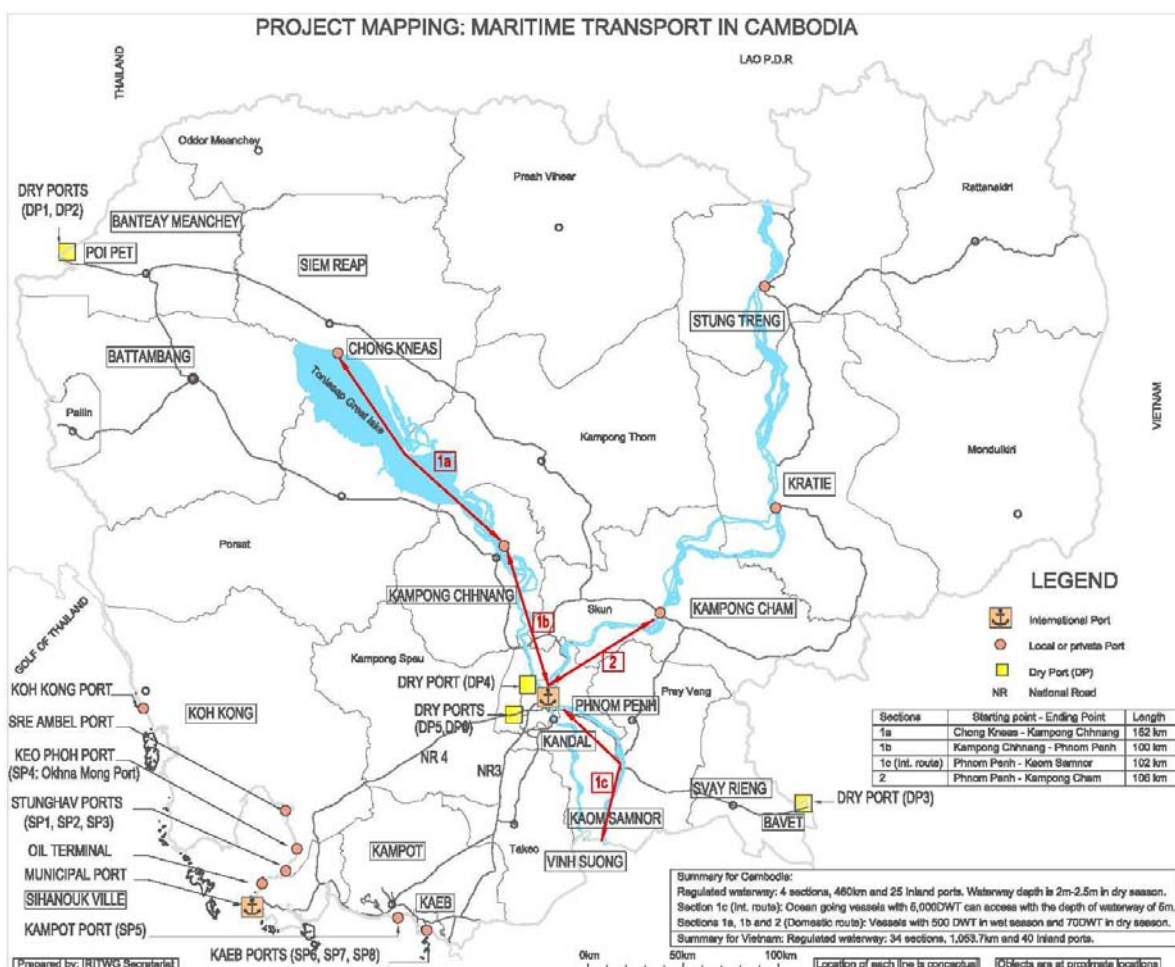

Figure 3-1: Local sea port in Cambodia

Source: MPWT

1). Phnom Penh port

The Phnom Penh port is the country's traditional river port, accessible to vessels from the South China Sea through Vietnam. Phnom Penh port is located in the city, on the Sap river some 3-4 km from its junction with the Mekong. It is some 348 km from the mouth of the Mekong of which about 102 km is in Cambodia and the rest in Vietnam. The distance from Singapore is about 1,450 km. Vessels of up to 2,000 DWT-can use the route without difficulty, and 5,000 DWT boats can pass the entrance to the Mekong (the 'Main bottleneck) on favourable tides. Regular dredging is necessary at three points in Cambodia for the 5,000.DWT vessels to reach Phnom Penh. The port serves up to 150 ships per year, including 3 Singapore- based cargo vessels which take 10-12 days for the return voyage.

Phnom Penh Port is under the management of state enterprise supervised by MPWT and Ministry of Economy and Finance. This autonomous enterprise was established by Sub-Decree 51, dated 17 July 1998.

a. Phnom Penh Port's Infrastructure

There are three Phnom Penh Ports: two main-cargo operational ports (Port No. 1 and Port No. 2) and another one is in the construction stage (Port No. 3):

- Port No. 1 (the main port) consists of a 184-m long pier built in reinforced concrete, plus three pontoons for sea-going vessels. There are two berths, known as Berths 4 and 5, which can accommodate ships up to 2,000 DWT and 4,000 DWT, respectively. Some 540 m of domestic pontoon capacity is available for riverine ships and barges of up to 100 m or 1,800-2,000 tonnes. The pontoons are served by lighters and junks. There are other berths available for small craft. There are 12 depots of 2,700 sq m and 5,910 tonnes storage capacity within some 180 m of the berths, plus open storage of some 4,300 sq. m. There is another warehouse complex at Kilometer 6 (Phnom Penh) having 15 sheds with a total capacity of 70,000 tonnes and 8 sheds of nearly 4,000 tonnes. Although actual crane capacity is not dear, there are 12 cranes- i.e. 2- 25 tonne units, 4-16 tonne and 6-6.5 tonne cranes.
 - Container Terminal:
 - ✧ Quay: 20m x 300m
 - ✧ Berthing Capacity: 3 vessels at one time
 - Passenger Terminal:
 - ✧ 2 Pontoons of 15m x 45m each
 - ICD:
 - ✧ Area: 92 000m²
 - Domestic Port:
 - ✧ Length 333m
 - ✧ Inter Provinces: PP - Kg. Cham, Phnom Penh - Siem Reap, & others
- Port No. 2, about 1 km south of the main area, consists of two 45 m by 10 m steel pontoons. Due to the long and narrow bridges and the seasonal variation in water levels, these two berths cannot be reached by equipment and are limited to bagged or other light traffic. The capacity of the main port (No. 1) has been estimated at about 150,000 tonnes per year, a figure already exceeded. This port is now to be rebuilt with the aid of a Japanese grant. The improvements are expected to increase the capacity to some 566,000 tonnes per year. As an interim measure, Port No. 2 will be rehabilitated under a World Bank credit. -When the improvements to Port No. 1 are completed, Port No. 2 could perhaps revert to domestic use (up to 1991, Port No. 2 was for domestic use only).
- Port No. 3: Because of several restriction to run 1st and 2nd ports, as well as their capacities are getting full, the third port is being constructed:
 - Location: 25km downstream from the 2nd ports in Phnom Penh (Along NR1 along Mekong River)
 - Funding : Chinese softloan of 28 million USD
 - Contractor: Shanghai Construction (Group) General Company
 - Construction Period: 30 months (Construction of infrastructure)
 - Request further budget to finance superstructure
 - Initial capacity: 120,000 ETUs/Year, Total Capacity = 300,000 TEUs/year
 - Berth = 22m x 300m
 - Port Area = 12 ha
 - To be operational by 2012

b. Phnom Penh Port's Equipment

Virtually all equipment at Ports 1 and 2 will be repaired or renewed under the two projects now getting under way. Port No. 1 will have adequate container handling equipment for the first time, and a new workshop.

Table 3-1: Status of equipments at Phnom Penh Port

Handling Equipments	Specification and quantity
Crane	6.5Ton: 03 units, 16Ton: 01 units, 25Ton: 03 units, 50Ton: 1 unit, 70Ton: 1 unit, 80Ton: 1 unit, 100Ton: 1 unit
Forklift	3.5Ton: 5 units, 6Ton: 3 units, 25Ton: 1 unit
Con-stacker	45Ton: 2 units
Sky-stacker	18Ton: 1 unit
Truck	08 units
Trailer	for 20' container: 6 units
Tugboat	550HP 1 unit, 680HP: 1 unit
Dredger N°1	Main engine: 840HP, Auxiliary engine: 150HP, Built: 1966, Dredging depth: 12m
Dredger N°2	Main engine: 1,200HP, Auxiliary engine: 400HP, Built: 1989, Dredging depth: 15m

Source PAS

c. Shipping companies

Several shipping companies made called at Phnom Penh Port:

- Sovereign base logistics company
 - 03 vessels (100 TEUs)
 - 02 Calls per weeks
 - 02 floating cranes and some trucks
- Gemadept Company
 - 03 Vessels (40 TEUs)
 - 02 Calls per weeks
- Hai Minh Company
- Other companies do not have own vessel (MOL, Hyundai, Hanjin)

d. Phnom Penh Port's Oil terminals

Oil is handled at separate terminals, at Km 4 and Km 13 north of the city on the Tonle Sap river. These are served by 600-1,000 DWT boats and also by Road 5.

Table 3-2: Status of facilities at Phnom Penh Port

Port Name	Channel	Berth					Other Facilities & Remarks
		Name	Structure	Length	Depth	Year	
Phnom Penh Port	Maintenance dredging (at Chaktomok) Depth: 7m Width: 60m Length: 1,290m Volume: 159,648m ³	Port No.1					[Container Yards] 2 yards for laden containers, 1 yards for empty containers
		No.1	Jetty, apron width 20m	Total 300m	5.0m	-	
		No.2			5.0m	-	
		No.3			5.0m	-	
		Port No.2 (for passengers)					1km downstream from Port No.1
		No.5b	Pontoon	15x45	3.5m	-	
		No.5c	Pontoon	15x45	3.5m	-	
		(Private Facilities)					Between 4 and 13km upstream from Phnom Penh
-	8 facilities for oil berges	Ship size from 600-1,000DWT		-			

Source: Prepared based on the Study on the Master Plan for Maritime and Port Sectors in Cambodia, March 2007 JICA (Updated by PAS)

2) Sihanouk ville port

The Port of Sihanouk Ville, situated in mouth of the Bay of Kompong Som, is the principal and only deep-water maritime port of the Kingdom of Cambodia. Kompong Som's natural advantages include deep water inshore and a degree of natural protection from storms provided by a string of islands across the mouth of the bay. The port was built in 1959 with a total capacity of 1.2 million encompassing the old French-built wharf and adjacent new facilities. The capacity of Sihanouk Ville port, in its present condition, is estimated at about 950,000 tonnes per year, excluding POL which has separate facilities. This is about twice its present traffic. The port can accommodate ships of 10,000 Dead Weight Ton (DWT).

The main access to the port is via a 5 km fairway channel, marked by buoys and leading lights for daylight navigation only. Due to rocky outcrops in the channel, the entrance to the port is restricted to vessels with a draft of less than 8.5 m. In practice boats of up to about 10,000 DWT can use the port. The port is located 540 nautical miles (1000 km) from Singapore.

On the land side, the port is served by NR4, NR3 (To Phnom Penh) and NR48 (To Koh Kong) and the railway

SL, completed in 1969, which takes a more southerly route via Kampot. Roads within Sihanouk Ville municipality itself are all hard surfaced, albeit of somewhat lesser quality and poorer condition than NR4.

The development of Sihanouk Ville port has been taking places several occasions:

- 1956-1959: Construction of Old Jetty with 290m long by 28m width and 9m draft (Donated by French Government)
- 1967- 1970: Construction of New Quay with 350m long by -10.5m draft
- 1986-1987: Conducted a Feasibility Study on the Development of Sihanouk Ville Port and Rehabilitation of Old Jetty with Technical Assistance of the former Union Society Soviet Republic (USSR) by using the National Budget.
- 1993: Adapted Cargo Transport Facilities from General Cargo to Containerized Cargo Transport System.
- 1996: Rehabilitation of Old Jetty by using ADB's fund.
- 1997- Present: PAS's Development by using Japanese ODA Loans.
 - Sihanoukville Port Urgent Rehabilitation Project, JBIC Loan N° CP-P3
 - Loan Amount: JP¥ 4,142,000,000
 - Consulting Services: Pacific Consultants International (PCI)
 - Civil Works: (February 2000)
 - Contractor: Penta-Ocean/Italian-Thai JV (March 2002- March 2005)
 - Scope of Works:
 - ◇ Dredging of Port Basin & Approach Channel : 758,800m³ (-9m)
 - ◇ Construction of Container Berth with 240m long (-11.5m)
 - ◇ Container Yard Pavement : 54,000m²
 - ◇ Access Road & Diversion Road : 16,800m²
 - ◇ Navigation Aid (Buoy) : 7 sets
 - ◇ Generator Houses & Generator Sets (800KW x 3): 03 Sets
 - ◇ Weighing Bridge (60ton Capacity) : 01 Set
 - ◇ Gate Facilities (5 lanes) & Yard Fence : 928m .etc.
 - Sihanoukville Port Urgent Expansion Project, JBIC Loan N° CP-P4
 - Loan Amount: JP¥ 4,313,000,000.-
 - Consulting Services: Pacific Consultants International (PCI)
 - Civil Works: March 2005
 - Contractor: Penta-Ocean/Italian-Thai JV (October 2005- June 2007)
 - Scope of Works:
 - ◇ Dredging of Port Basin & Approach Channel: 622,000m³ (-10m)
 - ◇ Construction of Container Berth with 160m long (-11.5m)
 - ◇ Reclamation Works : 95,000m³
 - ◇ Administration One-Stop Service Buildingetc.
 - ◇ Procurement of Equipment:
 - ◇ Supplier: Mitsui Engineering & Shipbuilding Co., Ltd (June 2007- March 2010)
 - ◇ Project Cost: JP¥ 2,381,197,360.
 - ◇ QGC : 02 Units; RTG : 05 Units; Terminal Tractor & Chassis: 08 Units; and Container Terminal Computer Systems : 01 Set
 - Sihanoukville Port SEZ Development Project, JBIC Loan N° CP-P6
 - Loan Amount: JP¥ 318,000,000
 - Consulting Services: PCI in association with NK & KCEC (May 2007-July 2009)
 - Scope of Works:
 - ◇ Development Strategy Study Services
 - ◇ Engineering Services:
 - ❖ Review on Previous Report of the Feasibility Study
 - ❖ Investigation of Site Conditions Stage
 - ❖ Detailed Design Stage
 - ❖ Tender Assistance Stage
 - Operation and Management Study Services
 - Sihanoukville Port SEZ Development Project, Loan N° CP-P8 (Phase II)
 - Loan Amount: JP¥ 3,651,000,000
 - Consulting Services: Nippon Koei Co., Ltd in association with KRI Corp.
 - (Promotion & Operation): Estimated Feb. 2009
 - Consulting Services: Nippon Koei Co., Ltd in association with KCC Co., Ltd

- (Construction Supervision): Estimated March 2009
- Civil Works:
 - ◇ Under Processes of Contractor Selection
 - ◇ Issuance of Final Registration Certificate by CSEZB: September 2000
 - ◇ Estimated Construction Works: July 2009-April 2011
 - ◇ Marketing Promotion (Sale of Lots): May 2009
 - ◇ Construction Works by Tenant in SEZ: July 2010
- Scope of Works:
 - ◇ Construction of Access Road into SEZ Area and Bridge over Railroad.
 - ◇ Land filling of approximately 500,000 m³
 - ◇ Cutting of approximately 160,000 m³
 - ◇ Site grading of approximately 550,000 m²
 - ◇ Road works consisting of asphalt concrete road of approx. 75,000m²,
 - ◇ RC Road 15,000 m², Parking Pavement 8,400 m² and Side-walk 7,500m², etc.,
 - ◇ Green Area Preparation of approximately 52,000 m²
 - ◇ Construction of Buildings consisting of Administration Building; approx.1,260 m²,
 - ◇ Maintenance Management Building; approx. 365m², Service
 - ◇ Apartment: 20 lots x approx.100 m², Dormitory: 2Units x approx.2,000m², Main Gate and Sub Gate, etc.,
- Marketing promotion for Land Lots & Size for Land Lease (March 2010)
 - Big Lot: 3.5ha x 02 Lots = 07ha
 - Medium Lot: 2ha x 10 Lots = 20ha
 - Small Lot: 1ha x 22 Lots = 22ha
 - Total: 34 Lots = 49ha

a. Sihanouk Ville Port's Infrastructure

Sihanouk Ville Port has two wharfs:

- The Old Jetty, with berths for two 10,000 DWT and two 7,000 DWT vessels at a time. The wharf has a total length of 570 meters with a reported depth alongside of 8.5 meters. The jetty had been repaired under the ADB's Special Rehabilitation Assistance Project (SRAP);
- The "new" wharf", 350 m long and designed for a depth of 10.5 m. Due to situation this has been reduced to 8.5m only, however. The pavement of the apron is worn out and damaged.

The 'new' wharf area is sheltered by two breakwaters. The northern one was never completed, however, with the result that the entrance is some 200 m wider than planned. This may be aggravating some problems of waves and situation in the harbor.

Table 3-3: Infrastructure at Sihanouk Ville Port

Port Name	Channel	Berth					Other Facilities & Remarks	
		Name	Structure	Length	Depth	Year		
Sihanouk Ville Port	[South Channel] Length 5.5km Depth: 8.4m Width: 80-100m	Old Jetty	Jetty	290m	9.0m	1960	[Warehouses] 5 buildings, 36,000m ² [Container yard] 3 yards, 174,000m ²	
		Old Jetty	Jetty	290m	8.0m	1960		
		New Quay	Concrete Block-	350m	(10.5)m	1969		
	[North Channel] Length 1km Depth: 10m Width: 150-200m	Container Berth	Concrete Block-	400m	10.0(11.5)m	2007		
		(Private Facilities)						
		Sokimex	Jetty	200m	9.2m	-		
		-	Pontoon		6.5m	-		
-	Stone Wharf		53m	4.2m	-			

Source: PAS

b. Sihanouk Ville Port's Oil Terminal

Sihanouk Ville's oil terminal for the POL traffic is some 10 km north of the main port. This was originally an oil refinery, opened in 1969 and destroyed a year later at the outset of civil war. Its jetty has a draft of some 4.5 m and is used by the State Fuel Company and Shell to import refined oil in 1,500 DWT vessels from Singapore. The terminal is rail connected. Storage of 60,000 cu.m is in use, and another 80,000-100,000 cu.m may be possible to repair. The oil refinery is believed to be beyond repair.

There are periodic calls for the jetty and associated pipelines to be extended to their planned size, in order to reach a water depth of 10.5 m. Tankers of some 10,000 DWT would then be able to call. The Shell oil company is discussing a 'smaller project with CKC at present. This could either increase the length of the jetty to enable more 1,500 DWT boats to call, or dredge to allow 2,500 DWT boats to reach the jetty, or contain elements of both ideas.

Table 3-4: Status of facilities at Sihanouk Ville Port

Port Name	Channel	Berth				Other Facilities & Remarks	
		Name	Structure	Length	Depth		Year
Sihanouk Ville Port	[South Channel] Length 5.5km Depth: 8.4m Width: 80-100m	No. 1-2	Jetty	290m	9.0m	1960	[Warehouses] 5 buildings, 36,600m ² [Container yard] 3 yards, 110,000m ²
		No. 3-4	Jetty	290m	9.0m	1960	
		No. 5-7	-	350m	9.0m	2007	
		No. 8-9	-	400m	10.0m	2007	
	[North Channel] Length 1km Depth: 10m Width: 150-200m	(Private Facilities)					-
		Sokimex	Jetty	200m	9.2m	-	
		-	Pontoon	110m	6.5m	-	
		-	Stone Wharf	53m	4.2m	-	

Source: Prepared based on the Study on the Master Plan for Maritime and Port Sectors in Cambodia, March 2007 JICA (Updated by PAS)

c. Sihanouk Ville Port's New Quay

In accordance with the rapid increase of sea transport the Royal Government had extended another new wharf locating in the northeast. This wharf (namely New Port) is a quay completed its construction in 1969 with 350m long by -10m draft (currently 8.5m) and can accommodate three vessels for offloading and loading cargoes.

d. Sihanouk Ville Port's Anchorage

Can be communicated and each working from 7:00 to 17:30 or by one hour before arriving ship call, VHF channel N° 16 (156.80MHZ).

There are three anchorage areas

- Northern Anchorage 10 ° 39'5N, 103 ° 29'0E
- Southern Anchorage 10 ° 36'0'N, 103 °28'5E
- Tanker Anchorage 10 ° 39.5'N, 103 ° 25.7'E

e. Sihanouk Ville Port's Storage facilities

Several warehouses are available providing a total storage area of approximately 6,000 square meters. The two wharfs have a total of five warehouses with the total area of 36,000m² and total storage capacity up to 84,000 tons, one of which is being let out to an oil exploration company. The warehouses have been under-utilized in recent years because of their poor condition, particularly their leaky roofs. Warehouses 1, 2 and 4 are now being repaired under the SRA Project. They have a combined capacity of about 36,000 cub.m. Warehouse 3 was repaired earlier with domestic funds. Container storage and handling is also available. The container yard is 50,000 square meters in area. Regular and direct shipping links with Singapore and Bangkok are in place, with Cambodian-flag shipping (Camtran Ship) being the dominant carrier. In 1993, 15,000 TEU's (20 food equivalents) passed through Sihanouk Ville Port. An estimated 80 percent of the containers had origin/destination in Singapore. Behind the warehouses fronting the new wharf, there are railway platforms and tracks as well as a container parking area of some 17,600 sq.m. The container area is now being resurfaced under SRAP. Both wharves are also rail-connected.

Table 3-5: Warehouses at Sihanouk Ville Port

Terminal	Size (m2)	Capacity	Quantity
New Container terminal	64,000	4,578(TEUs)	01
Laden Container Yard	500	1,350(TEUs)	01
Empty Container Yard	3,500	2,052(TEUs)	01
Warehouses	36,000	84,000T	05
Reefer Container		54 Sockets	01

Source: PAS

Capacity of Container Terminal

- Maximum Storage Capacity: 7.900 TEU
- Terminal Maximum Capacity: 390.000 TEU/Year
- Average Productivity: 25box/Unit/Hour/Crane

Capacity of General Cargo Terminal

- Maximum Storage Capacity: 2,500,000 Ton
- Warehouse Maximum Capacity: 84,000 Ton
- Terminal Maximum Capacity: 2,700,000 Ton

f. Sihanouk Ville Port’s Service Equipment

In order to timely service the market-economic situation and adhere to safety performance in providing service to customers, PAS has prepared its operating facilities as follow:

- | | |
|--|--|
| <ul style="list-style-type: none"> ○ Main of Navigation ○ Tug boat 1800HP 01Unit ○ Tug boat 1600HP 02Unit ○ Tug boat 800HP 02Unit ○ Pilot boat 01Unit ○ Mooring boat 01Unit ○ Speed boat 01Unit ○ Patrol boat 01Unit | <ul style="list-style-type: none"> ○ Cargo Handling Facilities ○ Quay Gantry Cranes (QGC)-48T : 02 ○ Mobile Harbor Cranes 64T : 02 ○ Rubber Tyred Gantry Cranes (RTG)- 35T:07 ○ Super Stackers 45T : 06 ○ Empty Stacker 7.5T : 02 ○ Chassis/Trailers 20’-40’ : 25 ○ Shore Cranes 10-50T : 08 ○ Forklifts 5-25T : 10 ○ Trucks 10-20T : 10 |
|--|--|

Source: PAS

g. Ship call at Sihanouk Ville Port

As of 2008, there were 10 type of ship consist of 626 ship had been registered out of which 467 were foreign owned by 22 countries.

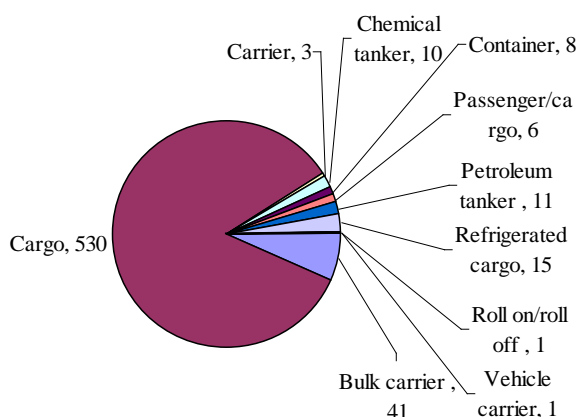

Figure 3-2: Type of ship

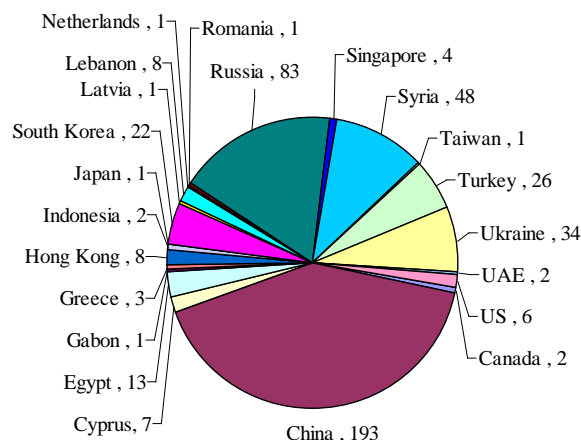

Figure 3-3: Foreign-owned ship

Source: CIA fact book

5 companies had their ship called regularly at Sihanouk Ville port:

Table 3-6: Ship call at Sihanouk Ville port

No.	Shipping Line	Number of call/week	Maritime Route	Schedule
1	Maersk Sealand (MCC)	3 calls	TPP – SIN – SIH – TH.SGZ	Wed. – Wed.
			HCM – SIH – LCB – HCM – HKG – TW.KAO – TPP – SIN – SIH	Wed. – Thu.
				Fri. – Sat.
2	RCL	3 calls	SIN – SIH – TH.SGZ – SIN	Wed. – Thur.
			HKG – SIH – TH.SGZ – SKG	Thur. – Fri.
			SIN – KUANTAN – SIH – TH.SGZ	Fri. – Sat.
3	American President Line (APL)	1 call	SIN – SIH – SIN	Fri. – Sat.
4	ITL	1 call	SIN – TH.SGZ – SIH – SIN	Fri. – Sat.
5	Cosco Toho Shipping (COTS)	2 calls per month	THAI – SIH – THAI	Not scheduled

Source: PAS

Note :

- | | |
|--|---|
| <ul style="list-style-type: none"> 1. SIH – Sihanouk Ville, Cambodia 2. HCM – Hochiminh Port, Vietnam 3. LCB – Leam Chabang Port, Thailand 4. TPP – Tanjung Pelapas Port, Malaysia | <ul style="list-style-type: none"> 5. HKG – Hong Kong Port, Hong Kong 6. TW.KAO – Kaoshung Port, Taiwan 7. TH.SGZ – Songkla, Thailand 8. SIN – Singapore Port, Singapore 9. KUANTAN – Kuantan Port, Malaysia |
|--|---|

3). The dry port

In 1993 Sihanoukville port suggested the concept of an inland clearance depot ('dry port') in the Phnom Penh area. Containers arriving in Sihanouk Ville could be taken by road or rail to the dry port for customs clearance, saving time and reducing inconvenience for customers based in Phnom Penh. In October 1994, it was announced that the project would go ahead under a joint venture agreement with a private Singapore company. Soon after several more dry ports had been constructed by privately own companies under the scheme of Build Operate Own (BOO) to help facilitate the maritime transportation.

Table 3-7: Dry port

No.	Project	Company	Investment scheme	Cost in Million USD	Between	Period (year)	Project Start
1	Construction of dry port at Poi Pet	LY SAYKHENG Co.,LTD	BOO		MEF and Private	-	2002
2	Construction of dry port at Bavet	HAN SENG LAND and PROPERTY Co.,LTD	BOO		MEF and Private	-	2002
3	Construction of dry port at Poi Pet	CHHAY CHHAY INVESTMEN LTD	BOO		MEF and Private	-	on studying
4	Construction of dry port at Km 6 Phnom Penh	GREEN TRADE COMPANY	-	-	MEF and Private	-	on studying
5	Construction of dry port at Chomchov NR3	OLAIR WORLDWIDE LOGISTIC CO., LTD.	BOO	2,5	MEF and Private	-	Licensed: July 2007
6	Construction of dry port at Chomchov NR4	TENG LAY IMPORT EXPORT AND TRANSPORT CO.,LTD.	BOO	6.2	MEF and Private	-	Licensed: July 2007

Source: MPWT

4) Maritime port

Beside Sihanouk Ville port located in newly established Sihanouk Ville province, Cambodia maritime ports located mainly in Koh Kong and Kampot provinces.

a. Port at Koh Kong

The Koh Kong provincial port is really a system of three ports. Vessels entering Cambodia from Singapore, Malaysia or Thailand call first at Paklong, on the Gulf of Siam about 15 km from the Thai border, for customs clearance and other formalities. Up to 300-tonne capacity boats can be accepted, or 500 tonnes at anchorage. The 300-tonne boats can then proceed across the bay to Koh Kong town for unloading or transshipment to smaller vessels if required.

Koh Kong is a small provincial capital with no road access to the rest of Cambodia. Road 43 can only be used (with difficulty) by motor cycles at present. Thus after clearance most boats proceed to another provincial port at Sre Ambel, at an inlet the Kompong Som Bay near Road 4, some 170 km from Phnom Penh. Sre Ambel can only accept 120-130 tonnes boats, however. Traffic that arrives at Koh Kong in larger boats has to be transhipped between vessels at Paklong or Koh Kong town.

Paklong and Koh Kong have quite good but limited facilities and are very congested, particularly Paklong. There is some warehousing in Koh Kong town to support the transshipment activity. Koh Kong is also a quite an important fishing port, from which about 16,000 tonnes were exported to Thailand in 1993.

b. Ports at Kampot

Cambodia's other seaports are at Kampot., 148km from Phnom Penh along Road 3 or 166km by rail. The port is situated in the town on a river bank 4 km from the sea. Of the minor ports, Kampot is the most important coastal facility. It was more important before 1975 when it had better facilities and was able to take vessels of up to 150 tonnes or more. It is a lighter port, with two main approaches from the sea, one of which has fairway depths of 10 m to within 11 km of the port. The other southern channel could accommodate vessels of less than 4.6 m draft. There are three channels through which junks and lighters could enter the river to reach Kampot. A wooden jetty can be used by 30-40 tonne boats. There is a regular trade with Koh Kong, for exchange of goods with Thailand, but Kampot port is not itself used for international traffic.

Table 3-8: Cambodia's minor sea ports

No.	Project	Company	Investment scheme	Cost in Million USD	Between	Period (year)	Project Start
1	Port for Petroleum at Stoeung hav	SOKIMEX			Port Authority of Sihanouk Ville and Private		2001
2	OKNHA MONG PORT at Sre Ombel	OKNHA MONG PORT Co ,LTD	BOO		-	-	2004
3	Port for Petroleum at Stoeung hav	TELA PETROLEUM GROUP INVESTMENT CO.,LTD	BOO	14.50	Port Authority f Sihanouk Ville and Private	-	2004
4	International Port at Stoeung hav	ATTWOOD IMPORT EXPORT Co.,LTD	-	30.00	-	-	on studying
5	International Port at	KAMPORT PORT Co.,LTD	-	9.00	-	-	on the

No.	Project	Company	Investment scheme	Cost in Million USD	Between	Period (year)	Project Start
	Kampot						way
6	International Tourist Port at Kaeb	Aussic-Cam Group Investment and Development Co., Ltd (Local)	BOT		MPWT and Private		
7	International Tourist Port at Kaeb	Rotong Development Co., Ltd	BOT		MPWT and Private		
8	Commercial Port at Kaeb	KAEB POWER SUPPLY CO.,LTD	BOT	41	MPWT and Private	-	

Source: MPWT

3.3. Existing port traffic

The total traffic through the two main ports increased steadily from their construction in the 1950s to a peak of some 1.5 million tonnes in 1965 (including POL products). No reliable statistics are available for the 1970s. Since 1985, the total port traffic has recovered from 236,000 tonnes to almost one million tonnes in 1993. The Phnom Penh Port continued to handle most of the port traffic through the early 1960s, with close to one million tonnes in 1962-63. During the mid-1960s much of the traffic to and from countries unfriendly to South Vietnam had to be diverted via Sihanouk Ville. The new wharf was added and the southern railway line was constructed. In 1965 Sihanouk Ville handled two thirds of the total port traffic or about one million tonnes. The constraint on traffic through Vietnam was subsequently removed. Traditional volume exports via Sihanouk Ville (such as rice) decreased and since 1985 Phnom Penh has again carried more traffic than Sihanouk Ville every year.

At Sihanouk Ville some two-thirds of the traffic is imports and one-third exports. Cement and construction materials made up nearly three-quarters of the non-fuel imports in 1993. Most of the export was timber, logs and construction materials. In Phnom Penh as much as 92% of the 1993 traffic was made up of import mostly fuel but also nearly 100,000 tonnes of general cargo. The major exports are rubber and maize. Very few containers are handled in Phnom Penh although there is some evidence that the number is understated in the official statistics. Even if this is so, the number is still small. In contrast Sihanouk Ville is becoming increasingly important as a container port. Three shipping lines make regular weekly or fortnightly calls at Sihanouk Ville with containers from Singapore. Some 15,000 containers used the port in 1993, and the 1994 total is expected to be at least 18,000.

Singapore is the predominant overseas origin-destination for all three international ports (including Koh Kong). Although size breakdown is not available so the figures may not indicate the capacities on each route a small survey by the MPWT in Phnom Penh Port in 1992 gave the following results: It is believed that the import of oil through Sihanouk Ville by the Shell company is now reaching an annual rate of some 60,000 tonnes a year, well above the 1993 level Shell has invested in a new fleet of road Tankers. The oil import via Phnom Penh during 1994 is estimated at some 300,000 tonnes.

3.4. Status of Current Port Usage

Sihanouk Ville Port has a cargo handling volume of approximately 1.6 million tons, and Phnom Penh Port, approximately 740,000 tons. Both ports have been steadily expanding their handling volume, and have shown particularly remarkable increase in the handling volume of containers. Sihanouk Ville Port accommodated approximately 700 vessels in 2005, and Phnom Penh Port 1,070 vessels (mostly small barges). Container vessels account for 60% of vessels entering Sihanouk Ville Port. On the other hand, tanker barges account for 65% of vessels in Phnom Penh Port. At Sihanouk Ville Port, the development of a special economic development zone of 70ha that is integral with the port is underway with Japanese aid, in conjunction with the development of a container terminal. Six offshore oil fields are being developed off the coast of Sihanouk Ville Port. As a supply base for their development, materials and equipment for trial exploration and drilling are stored and supplied at Sihanouk Ville Port.

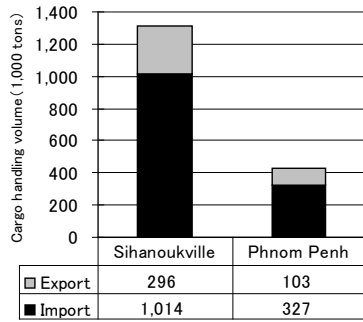

Figure 3-4: Annual cargo handling volume (2009)

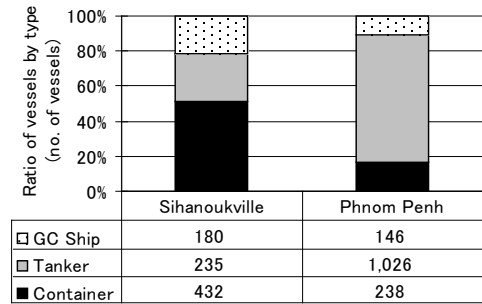

Figure 3-5: Number of vessels (2009)

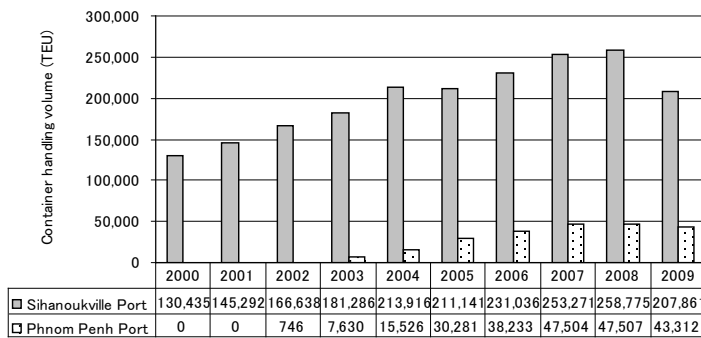

Figure 3-6: Trends in container cargo volume (2009)

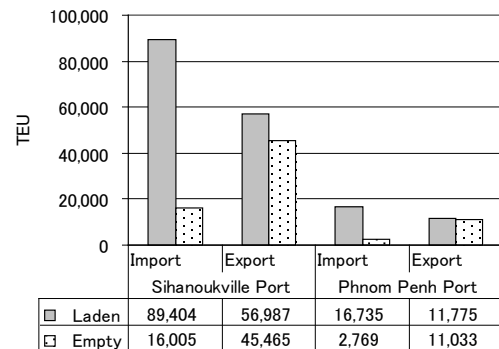

Figure 3-7: Ratio of empty and laden containers (2009)

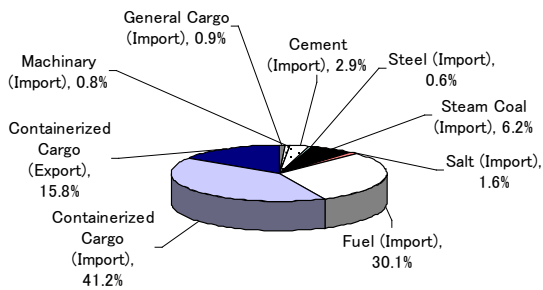

Figure 3-8: Composition of items handled at Sihanouk Ville Port (2009)

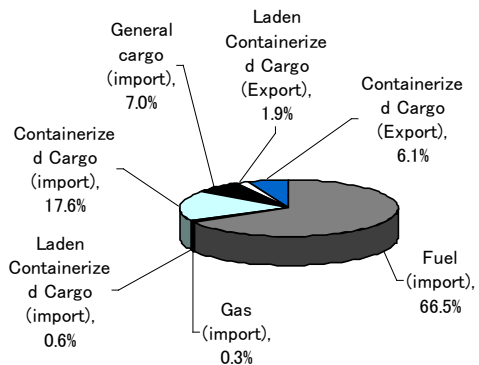

Figure 3-9: Composition of items handled at Phnom Penh Port (2009)

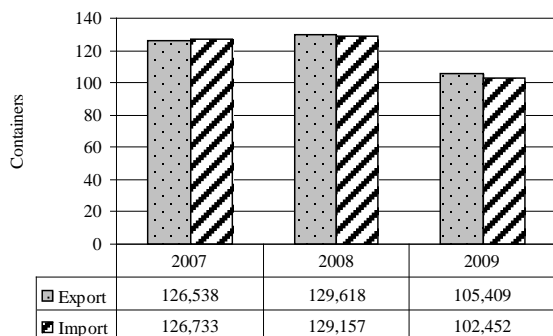

Figure 3-10: Import and Export Container at Sihanouk Ville port in 2009

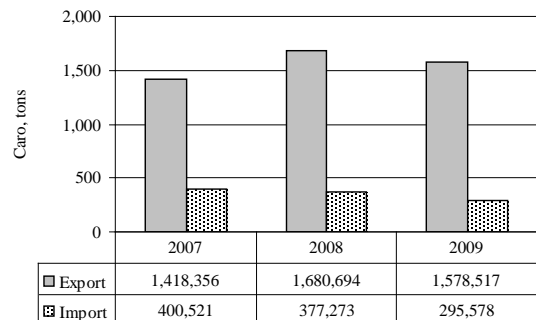
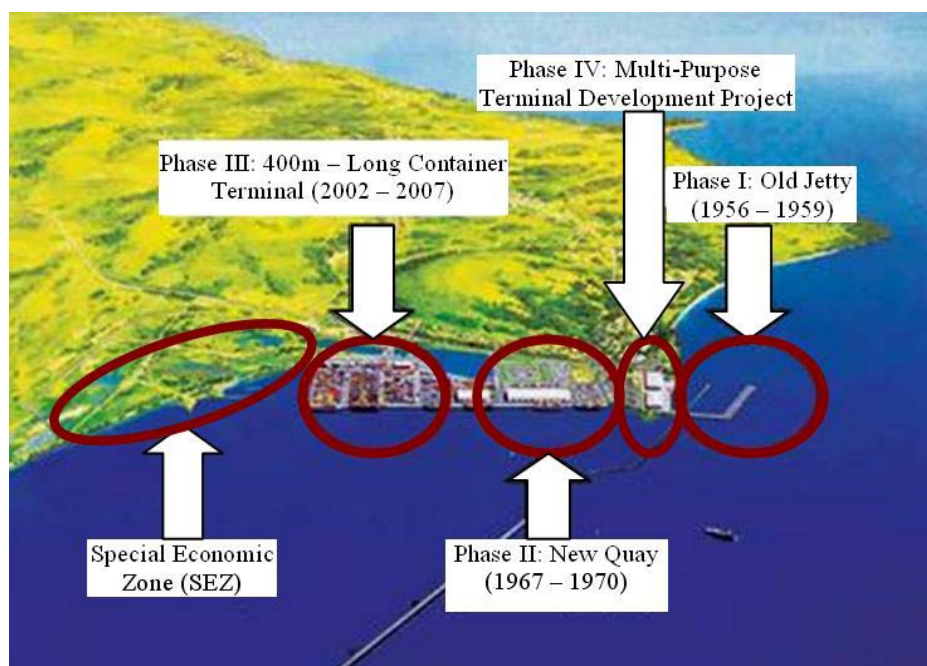

Figure 3-11: Import and Export at Sihanouk Ville port in 2009

Source: PAS & PAP

3.5. Future Development Plan



Source: MPWT

Figure 3-12: Long Term Development Plan (up to 2015)

Since the obtaining Special Economic Zone (SEZ) status (registered at CDC on September 2008 and received sub-decree on establishing of SEZ on 2nd September 2009), Construction works to create infrastructure at SEZ had started since October 2009 and expected to be completed by 2011. The Development Plan of PAS for 05 Year-Period (2009-2014) are:

1) Hardware development

- a. Continuous Construction of Sihanouk Ville Port Urgent SEZ Development Project (2009-2011)
 - Location behind Sihanouk Ville Port with 70ha
 - Land Filling and Cutting with approx. 660,000m³
 - Access Road into SEZ Area with Bridge over Railroad
 - Administration Building for Port SEZ = 1,260m², Road works: 75,000m², RC Road: 15,000 m²,
 - Parking Pavement: 8,400 m² and Side-walk: 7,500m², etc., Utility Works: Communication Systems, Electricity Works...
 - Container Freight Station (CFS),
 - Water Waste Treatment Plant
 - SEZ Boundary Fence, Main Gate and Sub Gate etc.
- b. Sihanouk Ville Port Multipurpose Terminal Development Project (2009-2014)
 - Project Cost: US\$ 87,882,000 (US\$74.5 Mil. + US\$13.3Mil.)
 - Multipurpose Terminal = Depth: -13.5m with length: 260m
 - Supply Base Berth = Depth: -7.5m with length: 200m
 - Dredging Works = 1,840,000m³
 - Reclamation Works = 154,000m³
 - Yard Pavement Works = 226,000m²
 - Procurement of Tugboat 01 Unit with Capacity of 3000 HP
 - Navigation Aids with 05 Sets of light buoys.
 - Estimated Construction Period = Nov.2011-April 2014
 - Estimated Start of Operation = May 2014
 - EIRR = 17.30% - FIRR = 8.10%
- c. Transfer the Old Jetty to be a Passenger Terminal (2010-2012)
 - Project Cost = US\$ 1,500,000

- Scope of Works:
 - Construction of Terminal Building.
 - Maintenance and Transfer the Old Jetty to be a Passenger Terminal.
 - Equip with Monitor & Control Systems.
 - Construction of Office Building.
- d. Sihanoukville Port SEZ Development Project – Phase III (2011-2015)
 - Project Location: Poimachov Village (17Km east of PAS) with 160ha
 - Project Cost = US\$ 35,000,000
- e. Reinforcement of Port Security and Safety in Maritime System (2010-2012)
 - Project Amount: US\$ 5,000,000
 - Scope of Works:
 - Fires Fighting Engines : 02 Units
 - Navigation Aids (Light Buoys) : 03 Sets
 - Light House for Navigation Aids : 02 Units
 - Procurement of Mooring Boat : 01 Unit ...etc
- f. The Study on Next Development Plan of New Container Terminal with -14m draft (2010-2011)

2) Software Development

- a. Increasing the activities of cargo/container handling operations in order to reach the volume of cargo throughput up to 3.5 Million tons by 2015.
- b. Improving the quality of operating services in accordance with the International Standard (Productivity, Effective Services & Smooth Services) by equipping Hi-Tech heavy handling equipment.
- c. Reducing the long administrative procedures by establishing One-stop Services Station to be equipped with Computer System and EDI.
- d. Reducing the service costs and conducting the accountancy for Port.
- e. Strengthening and preventing the terrorism by installing the control system equipment, security fences, and other emergency alarms system in order to prevent terrorism in the port area.
- f. Improving and strengthening security & safety activities and protecting the national environment.
- g. Integration into the region with other Asian Ports, especially members of APA.

4. INLAND WATERWAY TRANSPORT (IWT)

4.1. Background

Historically, inland water transport (IWT) has been the most reliable and conventional form of transport in Cambodia. Although it was thought before the 1970s that road and rail transport might replace it, it is now clear that IWT still remains the most important traditional and most useful mode of transport. The port is located along the main rivers: Mekong, Tonle Sap and Bassac rivers.

4.2. Present State of River Navigation

Cambodia's navigable inland waterways measure a total length of 1,750km. The Mekong mainstream accounts for 30% of the total, the Tonle Sap River 15%, the Bassac River 5%, and other tributaries 50%. Year-round navigation is possible through 580km long and a third of the width of the river. Inadequate dredging and navigation aids have been impediments to increased use of these waterways.

1) The Mekong in Cambodia

For the 102 km stretch between the border and Phnom Penh, the bends of the river prevent the passage of vessels more than 110m long. For existing cargo vessel designs this probably means a limitation of about 7,000 dwt. Boats up to 150 tonne capacity can be used as far as Kratie. Larger boats can be used at high water. At low water the 600-tonne boat can only carry 80 tonnes to Kratie while the 80- 130 tonne boats can usually carry 50-60 tonnes. Between Kratie and Stung Treng (120 km) 50- tonne boats can pass without difficulty in the rainy season but at low water levels the rocky conditions limit passable to smaller vessels of up to 20 tonnes. Above Stung Treng to Veuntham just across the Lao border only small boats can pass some 10-15 tonnes at low water and perhaps 50 tonnes at high water.

The Master Plan on Waterborne Transport in the Mekong River System in Cambodia, was developed in 2006, under the assistance of the Belgian Technical Cooperation. The Master Plan set out 60 action plans for the development of inland waterways transport in Cambodia. Some of the action plans are now under implementation.

2) Tonle Sap River and lake

On the Tonle Sap river the draft is about 1 m in the dry season but can reach up to 4 m in the rainy season. There is a water depth of only 0.5 m at the entrance to the Great Lake in the dry season. Some traffic between Phnom Penh and Siem Reap, for example goes by road from Phnom Penh to the Lake and then proceeds by boat at Kampong Chhnang or Battambang provinces. A high water boats up to 150 tonne capacity can be used between Phnom Penh and the Lake.

3) Bassac and other navigable waterways

The main other waterway of importance for commercial river transport is the Bassac which links Phnom Penh with Chau Doc, the capital of Vietnam's An Giang Province. This can be used by 100-tonne boats and it also has a network of tributaries and canals mostly in Takeo province which can take up to 100 tonne boats at high water but loads can be limited to 10 tonnes at low water. Most vessels on this network are in the 20-30 tonne range and are used for trade between Takeo and the Vietnam delta area. There is a small international port at Kompong Ampil in Takeo province, which is used by trucks from Phnom Penh.

Table 4-1: Maximum navigable vessel size in the Mekong River basin by section

River	River Section	Length (km)	Year-round navigation possible?	Vessel Size Restriction (DWT)	
				Low Water	Mean-high water
Mekong Mainstream	Golden Triangle - Luang Prabang	362	Yes - but is limited by rocky passages and strong currents		60
	Luang Prabang - Vientiane	425	Yes - but requires small boats and skilled pilots during dry season	15	60
	Vientiane - Savannakhet	459	Yes	200	500
	Savannakhet - Pakse	261	No "high water" only navigation possible	Less than 10	50
	Pakse - Khinak	151	Yes	50	
	Khinak - Veune Kham	14	No - navigation not possible at any time due		

Overview on Transport Infrastructure Sectors in the Kingdom of Cambodia (March 2010, IRITWG)

			Khone Falls		
	Veune Kham - Stung Treng	30	Yes - with size limitations at low water	15	50
	Stung Treng - Kratie	128	Yes - with size limitations at low water	20	50
	Kratie - Kampong Cham	121	Yes	80	400
	Kampong Cham - Phnom Penh	100	Yes - navigable by sea-going ships	2,000	
	Phnom Penh - Junction of Vam Nao Pass	154	Yes - navigable by sea-going ships	3,000-4,000	5,000
	Vam Nao pass - South China Sea	194	Yes - navigable by sea-going ships	3,000-4,000	3,000- 4,000
Bassac River	Phnom Penh - Junction of Vam Nao Pass		Yes - but not possible by sea-going ships	20	50
	Vam Nao Pass - South China Sea	188	Yes - navigable sea-going ships	5,000	5,000- 6,000
Tonle Sap (Cambodia)	Phnom Penh - 5km South of Kampong Chhnang	94	Yes - navigable by sea-going ships	1,000	2,000
	Kampong Chhnang - Chhnoc Trou	46	Yes - with size limitations at low water	20	150
	Chhnoc Trou - Chong Kneas109	109	Yes - with size limitations at low water	20	150
Mekong Delta Waterways	Dense network of man-made canals, natural creeks and Mekong tributaries, with a total navigable length of 4785 km	4,785	Yes - Vessel size restrictions within this network vary from 10-300DWT		
	Se-kong - Mekong tributary (Lao PDR and Cambodia)		Yes - this waterway is navigable between the Lao PDR and Cambodia, providing an alternative international transit corridor to the Mekong which is non-navigable through the Khone Falls		

Source: Master Plan for Waterborne Transport on the Mekong River System in Cambodia, Final report (Volume 1 Main Report, Draft), September 2006, Belgian Technical Cooperation

Table 4-2: Maximum navigable vessel size in the Mekong River basin

	Mekong Mainstream up to Phnom Penh	Mekong River, Phnom Penh to Kampon Cham	Tonle Sap, Phnom Penh to Siem Reap
Petroleum	Tanker barges 1,000 DWT / 4.0m draught	-	-
Container	Barges 1,900 DWT (120TEU) / Draught 3.8m	-	-
General Cargo	Barges 1,500 DWT / Draught 4.0m	-	-
Tourist Cruise Vessels	50-65 passengers Draught 1.5m	-	50-65 passengers Draught 1.5m
Speedboats	25 passengers shallow draught	-	25 passengers shallow draught

Source: Master Plan for Waterborne Transport on the Mekong River System in Cambodia, Final report (Volume 1 Main Report, Draft), September 2006, Belgian Technical Cooperation

4.3. Vessels and Traffic

During the 1980s most commercial river transport in Cambodia was handled by the River Transport Company (RTC) a semi-commercial joint venture between Government and a private company. The volume of cargo handled was about 80-100,000 tonnes per year (some 30 million tonne-km) carried by a total of 32 vessels ranging from 120 tonnes to 1,120 tonne. Although there are no proper shipyards wooden boats of up to some 150- tonne capacity are built along the river banks by local carpenters and are generally of good workmanship. Engines and other equipment can be bought at the market in Phnom Penh. Half of all boats currently in commercial traffic are less two years old. Almost all are operated by the respective owners with the help of employed crews. The boats are registered, inspected and taxed by the provinces in which they are based.

A few specialized passenger liners serve the routes to Kompong Cham and to Siem Reap, but most commercial passenger traffic is undertaken over short distances and by smaller craft. For vessels of 20 tonnes and up, serving the longer routes, most of the revenues by far are derived from goods transport. The main commodities carried are timber and agricultural produce to Phnom Penh; and foodstuffs and household goods from Phnom Penh.

4.4. Inland Water Ports

More than 3.9 million Cambodian living along the Inland Waterways networks in Cambodia, which consist of 3 main artery: a) Mekong River (upstream to Lao P.D.R and down stream to Vietnam, b) Basac river (to Vietnam) and c) Tonle Sap river (Including Tonle Sap great lake to Siem Reap port). These three major waterway transport line run across 6 provinces:

- | | | |
|--------------------------|---------------------|---------------|
| 1- Phnom Penh (domestic) | 3- Kratie (Kracheh) | 6- Pursat |
| 2- Kampong Cham | 4- Stung Treng | 7- Siem Reap |
| | 5- Kampong Chhnang | 8- Battambang |



Source: Master Plan for Waterborne Transport on the Mekong River System in Cambodia, Final report (Volume 1 Main Report, Draft), September 2006, Belgian Technical Cooperation

Figure 4-1: Maximum navigable vessel size in the Mekong River basin

The most important domestic ports are in Phnom Penh and at Kompong Cham, Kratie and Stung Treng on the Mekong, and Kompong Chhnang, Chhnok Trou, Krakor and Siem Reap on the Sap river and lake. Thus the Mekong is important both for internal journeys between the provinces and for the distribution of goods via Phnom Penh port. Traffic is transhipped from ocean-going to smaller vessels in Phnom Penh.

1) Phnom Penh Port

There are two domestic ports in Phnom Penh, situated side-by-side at Km 3 north of the city, sandwiched between Road 5 and the River Sap. The most active and congested area is the northerly one, run by Phnom Penh Municipality. The adjoining southerly site comes under the jurisdiction of the main Phnom Penh port, under MPWT. The site is a temporary one, to which the ports were moved in December 1993. The previous area in the city centre, south of Port No. 2, was cleared to make way for a linear park along the river bank. Earlier, in 1991, Port No. 2 was designated for international rather than domestic use, because of congestion at Port No. 1.

2) Kompong Cham Port

Kompong Cham is one of the most important provinces in Cambodia, situated on a cross-roads of two main trading routes: north-south along the Mekong from Laos to the sea., and east- west between Thailand and Vietnam along the historic route via Siem Reap. It is growing quickly and is an important centre for the rubber plantations. Much of the transport to and from Phnom Penh is by river. Apart from the Road 7 ferry, there is a passenger landing and a 10 m long pontoon for barges up to about 400 tonne capacity. During the dry season the pontoon is grounded and the river bank is used. There is also a warehouse with a covered area of 550 sq.m, said to have a capacity of about 600 tonnes. Across the river from the town, on the left bank, there is some 5,700 sq.m of open storage area.

3) Kratie Port

As Road 7 is very poor and indirect, most of the current traffic between Phnom Penh and Kratie is carried by river. Kratie is a provincial capital and another important centre for the rubber trade. The port has a 35m long pontoon, used only in the rainy season, and a 1,000 sq.m warehouse said to have a capacity up to 5,000 tonnes.

4) Stung Treng Port

Stung Treng is an important regional centre, located where the Sekong joins the Mekong and also with road access both to Laos (Road 7) and the Vietnam (Road 78). A ferry brings the traffic along Road 7 across the Sekong, but is not much used in the present security situation. The Sekong and its tributaries San and Srepok provides the only means of access to large parts of the Stung Treng and Rattanakiri provinces. Some 130 vessels are registered in Stung Treng including about 50 in the range 10-35 tonnes. There are no dedicated port facilities, however. The river banks have to be used, or during the low water season - the temporary jetty provided for the ferry.

5) Kompong Chhnang Port

Kompong Chhnang is on the Tonle Sap River, between Phnom Penh and the Great Lake. It has a fishing port at Chhnok Trou and is also a market town for a rather large area on both sides of the Sap river, and lake. Much of the boat traffic transships between road and river, for journeys to/ from Phnom Penh. The port facilities are congested, with a large adjacent market area, and the whole area needs improvement and paving. At present, however, the function of the port is more of a provincial one than a national one, as larger vessels cannot enter the lake at low water.

6) Pursat Port

It has a fishing port at Krakor, which is an important site at the south-east corner of the Tonle Sap Lake. It is important for fishing but also as transshipment point between boats and road transport for journeys between Siem Reap and Phnom Penh. Unlike the River Sap the lake is navigable the whole year and is used both for passenger and goods traffic. Most of this traffic uses Road 5 to and from Phnom Penh.

7) Siem Reap Port

The port for Siem Reap is located 5 km from the city and can only be used at high water. During the dry season the water level may be as much as 10 m lower and up to 11 km from the port. An access road (which is totally inundated at high water) then connects the town to the lake. A temporary wooden port is constructed at the beginning of each dry season but is destroyed together with any improvements to the access road as the water rises. There are also various mooring places along the access road for intermediate water levels. The port is mainly used for goods traffic to/from Phnom Penh either directly via the Tonle Sap River or with transshipment in Krakor or in Chhnok Trou in the southern end of the lake. Some 12 passenger vessels also ply the route and there are some new express services for tourists to Angkor Wat.

8) Battambang Port

The port of Battambang is located right in the middle of the town and it could only be used at high water (July – November). Even though in rainy season (high water level), the boat has to navigate through shallow and narrow places. Tourists are the main passenger. Local passenger tends to travel by road due to the improvement of national road linking Battambang to the rest of the country.

4.5. Regulated Waterway¹ in Cambodia

Phnom Penh's port is on the Mekong River so access is through the delta in Vietnam and through Ho Chi Minh City. In regard condition, to get access to the sea, Cambodia has to negotiate with the Vietnamese. The negotiation on regulated waterways and transit routes started in late 90's and it was on 17th December 2009 that the Agreement had been signed in Phnom Penh. Transit routes² between Vietnam and Cambodia could be made by the following routes:

- The Mekong/Tien River route via the Cua Tieu up to Phnom Penh Port follows regulated waterways No. 1a, 1b, 1c, 1d, and 1e in Vietnam and No. 1c and 1b in Cambodia and vice versa.
- The Bassac/Hau River route via the Cua Dinh An and further via the Vam Nao Pass and the Mekong/Tien River up to Phnom Penh Port follows regulated waterways No. 2a.3, 2a.2, 2a.1, 1c, 1b and 1a in Vietnam and No. 1c and 1b in Cambodia and vice versa.

The critical section for the Mekong route which is preferred by Cambodia is the river mouth with a depth of only 2.4 m during low tide and 4.5 m during the average high tide (allowing vessels up to 2,000 and 4,000 dwt respectively).

Table 4-3: Regulated Waterway in Cambodia

Section	Name of Waterway	Starting Point – End Point	Length (km)
1a	Tonle Sap Lake	From Chong Kneas to Kampong Chhnang	152 km
1b	Tonle Sap	From Kampong Chhnang to Phnom Penh	100 km
1c	Mekong River	From Phnom Penh to the Kaom Samnor/Vinh Xuong border gate	102 km
2	Mekong River	From Kampong Cham to Phnom Penh	106 km

Source: MPWT

4.6. Inland Waterway Transport ports

Under the Agreement between Royal Government of Cambodia and the Socialist Republic of Vietnam, local trade could utilize the freedom of navigation³ and could call at 25 ports in Cambodia and 40 ports in Vietnam. Most of the ports are privately own by mostly fuel or import-export related companies.

Table 4-4: Inland Waterway Transport ports in Cambodia

No.	Name of the Ports/Terminals/Port Groups	Ownership	Rivers	Type of Cargo	River Class.	Specifications		
						Length (m)	Width (m)	Depth (m)
1.	Conventional and Passenger floating Piers. (TS1)	PPAP	Tonle Sap	General cargo, Passenger	Unspecified	45	15	5.3
2.	Conventional (TS3) Container terminal	PPAP	Tonle Sap	General cargo, terminal	Unspecified	300	20	6.3
3.	Domestic terminal (TS5)	PPAP	Tonle Sap	General cargo	Unspecified			4.5
4.	Sokimex Floating Pier (TS7)	Sokimex Co.ltd	Tonle Sap	Fuel	Unspecified	30	7	4.6
5.	Sokimex Floating Pier (TS9)	Sokimex Co.ltd	Tonle Sap	Fuel	Unspecified	15	6	4.0
6.	Terminal km 6 (TS11)	Green Trade Co.ltd	Tonle Sap	General cargo	Unspecified	40	5	4.0
7.	Prek Pnheu Pier (TS15)	Siem Gas Co.ltd	Tonle Sap	Gas	Unspecified	Two piles		5.0
8.	Tela Terminal (TS17)	Tela Co.ltd	Tonle Sap	Fuel	Unspecified	30	8	4.6
9.	Bright Victory Pier (TS19)	Bright Victory Co. ltd	Tonle Sap	Fuel	Unspecified	25	6	4.6
10.	Men Sarun terminal (TS21)	Men Sarun Co.ltd	Tonle Sap	General cargo	Unspecified	200	15	5.0
11.	Kampong Chhnang Port	MPWT	Tonle Sap	Domestic General cargo	Unspecified	20	6	4
12.	<i>Siem Reap Port (Chong</i>	<i>MPWT</i>	<i>Tonle</i>	<i>Domestic General</i>	<i>Unspecified</i>			

¹ 'Regulated waterways' means the waterways and stretches of waterways belonging to the Mekong river system within the respective territories of Cambodia and Vietnam, which are listed in Table 4-3 and **Error! Reference source not found.** or any other waterway jointly designated by Cambodia and Vietnam.

² 'Transit routes' means those parts of the regulated waterways which are open to maritime vessels engaged in transit transportation

³ Freedom of navigation comprises the right to use the ports, terminals and port groups as specified in Table 4-4 and **Error! Reference source not found.** Competent Authority of either Cambodia or Vietnam may declare the opening additional ports, terminals and port groups. Such a declaration shall be notified to the other party through the Mekong Navigation Facilitation Committee.

Overview on Transport Infrastructure Sectors in the Kingdom of Cambodia (March 2010, IRITWG)

No.	Name of the Ports/Terminals/Port Groups	Ownership	Rivers	Type of Cargo	River Class.	Specifications		
						Length (m)	Width (m)	Depth (m)
	<i>Khneas</i>		<i>Sap</i>	<i>cargo, passenger</i>				
13.	Mekong Shore berth (Bright Victory Branch)	Bright Victory & Mekong Petroleum Co. Ltd	Upper Mekong	Fuel	Unspecified			5.5
14.	Prek Anchanh Shore, Berths. (UM1)	PPAP	Upper Mekong	Wood products	Unspecified			5
15.	Tonle Bet Shore Berth (UM2)	PPAP	Upper Mekong	General cargo	Unspecified			5
16.	Kampong Cham, Domestic terminal (UM3)	PPAP	Upper Mekong	General cargo, passenger	Unspecified			4
17.	Dey Eth Terminal (LM5)	PPAP	Lower Mekong	General cargo	Unspecified	35	20	14
18.	Total Floating Pier (LM11)	Total Co. Ltd	Lower Mekong	Fuel, Gas	Unspecified	30	6	10
19.	<i>New container terminal (LM17)</i>	<i>PPAP</i>	<i>Lower Mekong</i>		<i>Unspecified</i>			<i>10</i>
20.	Petronas Floating Pier (LM19)	Petronas Co. Ltd	Lower Mekong	Fuel	Unspecified	30	6	14
21.	Prek Ksay floating Pier	LHR Asean Investment Co. Ltd	Lower Mekong	Fuel	Unspecified	20	6	2
22.	Sokimex Prek Ksay Pier (LM2)	Sokimex Co. Ltd	Lower Mekong	Fuel	Unspecified			3
23.	Neak Loeung	PPAP	Lower Mekong	General cargo	Unspecified			4
24.	Asia Flour Mill Corporation Shore Berth (TB3)	Asia Flour Mild Co. Ltd	Lower Mekong	General cargo	Unspecified			6
25.	Chak Angre Floating pier (TB5)	EDC, Chak Angre	Tonle Bassac	Fuel	Unspecified	25	6	4

Source: MPWT

Note: Port written in italic indicated it's progress is in development (expect to be completed).

5. AIR TRANSPORTATION

5.1. Background

Cambodia has 3 international airports, 9 local airports and dozen of airfields. Most were built pre and during world war two to serve the commercial and war effort. Air transport service ceased to function during the Khmer Rouge period (1975-1979). Since 1980, air service started to operate with limited capacity due to budget constraint, human resource and security. In 1998, to counter Asian economic crisis, the open sky policy was introduced so that foreign flight could be made directly to Siem Reap without stopping over in Phnom Penh. Following the introduction of liberal open sky policy, the State Secretariat of Civil Aviation (SSCA) had signed air services agreement (ASA) and memorandums of understanding (MOU) with 22 countries.

State Secretariat of Civil Aviation Established under:

- Royal Decree(Kram) SH RDC 0196 on the formation of State Secretariat of Civil aviation (SSCA) dated 24 Jan 1996,
- Sub-decree (SDC) No.12 on the organization and functioning of State Secretariat of Civil aviation (SSCA).
- Civil Aviation Law promulgated on 19 Jan 2008.
- Civil Aviation Regulations.

5.2. Present State of Airports

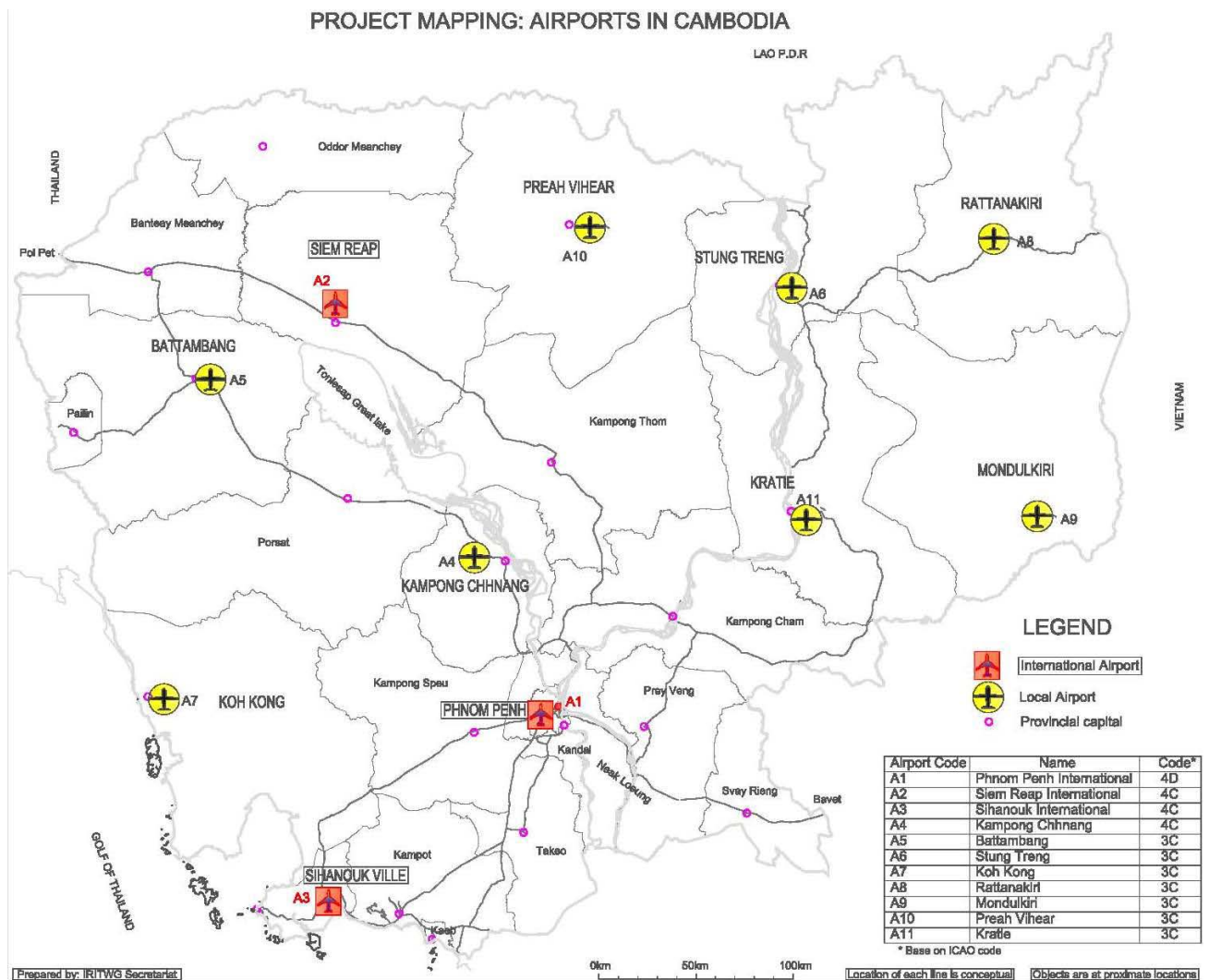

Figure 5-1: Location of Airports in Cambodia

There are 11 airports in Cambodia, but regular flights are only available at 2 airports: Phnom Penh and Siem Reap International Airports. The Société Concessionnaire de l'Aéroport (SCA) has been undertaking operational management of Phnom Penh International Airport since 1995, Siem Reap International Airport since 2001, and Sihanouk Ville Airport since 2006. These are under BOT Agreements between the Royal Government of Cambodia and SCA. All other airports are managed by the State Secretariat of Civil Aviation (SSCA) except for Kampong Chhnang Airport.

Table 5-1: Present status of airports in Cambodia

Airport	Runway (m) Surface/Ref. Code	ILS	Area (ha)	Owner/ Operator	Open/ Close	Remarks
International Airport						
Phnom Penh	3000x45/ Asphalt/ 4D	*	387.00	RGC/SCA	Open	ILS for RWY23 only
Siem Reap	2550x45/ Asphalt/ 4C	*	197.00	RGC/SCA	Open	ILS for RWY05, will be operated in early 2009
Sihanouk Ville	2500x34/ Asphalt/ 4C		123.84	RGC/SCA	Open	Reopened January 15, 2007. Now, in Preparation for official opening as Int. Airport (Sub-Decree No.61 had been issued on 21 st April 2009)
Domestic Airport						
Kampong Chhnang	2400x45/ Concrete/ 4C		2011.00	RGC/Air Force	Close	The Area includes military land use
Battambang	1600x34/ Bitumen/ 3C		128.68	RGC/SSCA	Open	
Stung Treng	1300x20/ Bitumen/ 3C		112.50	RGC/SSCA	Open	
Rattanakiri	1300x30/ Laterite/ 3C		48.09	RGC/SSCA	Open	
Koh Kong	1300x30/ Laterite/ 3C		125.66	RGC/SSCA	Open	
Mondulkiri	1500x30/ Laterite/ 3C		36.00	RGC/SSCA	Close	Closed since July 2007. Recently request by the private to re-open.
Preah Vihear	1400x30/ Laterite/ 3C		150.98	RGC	Close	
Kratie	1180x30/ Laterite/ 3C		112.50	RGC	Close	

Source: SSCA

5.3. Airport infrastructure

1) Phnom Penh international airport (former Pochentong int. Airport)

It was built during world war two by force labor and later was upgraded to international standard. The existing structure comprises a newly built taxi way, a single asphalt runway of 3,000 metres (9,843ft) long by 40 metres wide, a rigid concrete apron, air traffic control, operations/administrative building and other basic ancillary facilities. There is also military traffic at Phnom Penh International Airport (south campus). The management of Phnom Penh international airport is under private company, Société Concessionnaire d'Aéroport (SCA)¹, who obtained a concession from the government on 6th July 1995.

Table 5-2: Phnom Penh International Airport infrastructure

Elevation AMSL	Coordinates	Website	Direction
40 ft / 12 m	11°32'47"N104°50'38"E 11.54639°N 104.84389°E	http://www.cambodia-airports.com/index.php	05/23
Infrastructure			
<ul style="list-style-type: none"> • Total capacity: 2 million pax <ul style="list-style-type: none"> ○ Surface: 16,000 m² ○ Waiting lounges: 1300 m² ○ VIP Lounge: 250 m² ○ Food & Beverage: 350 m² ○ Duty Free: 700 m² • Seat capacity: 360 		<ul style="list-style-type: none"> • Check-In counters: 22 • Visa, Immigration and Customs counters: 30 • Number of gates: 4 with aerobridges, 2 with bus access • Baggage conveyors: 2 (International) • Car parking: 380 	

Source: DAFIF & SSCA

2) Siem Reap International Airport

This airport is located about 8km North – West of Siem Reap capital. It has a total area of 195ha. It has the access to NR6. This airport serves as a main entrance for international tourist who come to visit Angkor Wat.

¹ 70% owned by Groupe GTM and 30% by Muhibbah Masterron of Malaysia

Likewise Phnom Penh International Airport, Siem Reap International Airport is also under the Société Concessionnaire d'Aéroport (SCA). Under "Open Sky" policy, international flight could be made directly to this airport.

Table 5-3: Siem Reap International Airport infrastructure

Elevation AMSL	Coordinates	Website	Direction
60 ft / 18 m	13°24'38"N 103°48'46"E 13.41056°N 103.81278°E	http://www.cambodia-airports.com/	05/23
Infrastructure			
<ul style="list-style-type: none"> ○ IATA code: REP; ICAO code: VDSR ○ Airport category: 4 C ○ International terminal: 13,000 square meters (with possible extensions). Handling capacity: 1.5 million passengers ○ Domestic terminal: 700 square meters ○ Airlines regularly operating: 16 (Air Asia, Air Macau, Asiana Airlines, Bangkok Airways, China Eastern Airlines, China Southern Airlines, Far Eastern Air Transport, Hong Kong Airlines, Japan Airlines, Jetstar Asia, Korean Air, Lao Airlines, Malaysia Airlines, Siem Reap Airways, Silk Air, Vietnam Airlines). ○ Runway length: 2,550 meters ○ Runway width: 45 meters, with shoulders 2.5 meters wide each 		<ul style="list-style-type: none"> ○ Perpendicular taxiway (taxiway A): 1 (length: 240 meters; width: 20 meters and 10 meters of shoulders). Parallel taxiway (taxiway B): 1 (length: 600 meters; width: 23 meters and 15 meters of shoulders) ○ Number of stands: 16 ○ Navigation aids and visual aids: <ul style="list-style-type: none"> ▪ ILS ▪ VOR/DME ▪ NDB ▪ PAPI ○ ICAO level: 8 ○ Equipment: 3 ○ Vehicles: 1 fire truck ○ Ambulance: 1 ○ Cargo Terminal: total surface area is 649 sq.m 	

Source: DAFIF & SSCA

3) Keng Kang airport (or Sihanouk Ville International Airport)

Sihanouk Ville International Airport (IATA: KOS, ICAO: VDSV), located 18 km east of Sihanoukville, is Cambodia's third international airport. The airport is also known as Kang Keng Airport. The IATA code KOS dates from Sihanoukville's former name Kompong Som. The airfield was originally constructed in the 1960s with assistance from the Soviet Union. After a long period of dormancy during and after the Khmer Rouge era, the airport formally reopened on 15th January 2007. The airport's runway is being extended to 2,200 meters, which will allow it to accommodate jet airplanes such as the Boeing 737.

Table 5-4: Sihanouk Ville International Airport infrastructure

Elevation AMSL	Coordinates	Website	Direction
40 ft / 12 m	10°34'48"N 103°38'13"E 10.58°N 103.63694°E	http://www.cambodia-airports.com/index.php	-
Infrastructure			
<p>General information</p> <ul style="list-style-type: none"> ○ Total land area: 682 ha ○ Airport category: 3 C ○ International & domestic terminal: over 1,000 square meters <p>Rescue and Fire Fighting</p> <ul style="list-style-type: none"> ○ ICAO level: 5 ○ Equipment: 1 firefighting vehicle 		<p>Airfield</p> <ul style="list-style-type: none"> ○ Runway length: 2,500 meters ○ Runway width: 40 meters ○ Perpendicular taxiway: 1 ○ Number of stands: 5 ○ Navigation aids and visual aids: <ul style="list-style-type: none"> ▪ VOR/DME ▪ NDB ▪ PAPI 	

Source: DAFIF & SSCA

5.4. Present State of Airport Usage

The usage of international airports has been increasing yearly owing to the increase of tourist demand.

The number of international flights per year varies from year to year, and during 5 years between 2003 and 2009, it has increased approximately 1.4-fold at Phnom Penh International Airport and approximately 1.9-fold at Siem Reap International Airport. The number of domestic flights, on the other hand, has been decreasing on the whole.

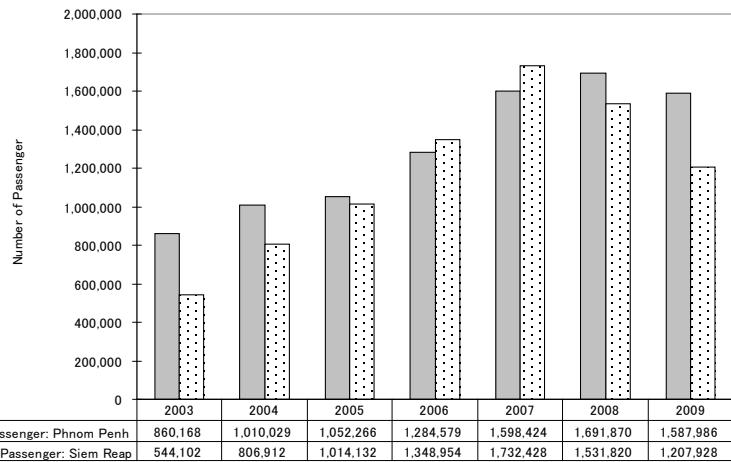

Source: SSCA

The number of international flight passengers has been increasing yearly (except in 2009) at Phnom Penh International Airport, and has marked 1.5 million in 2009. When combined with the number of domestic flight passengers, the airport is used by a total of some 1.6 million passengers a year.

Figure 5-2: Number of passengers.

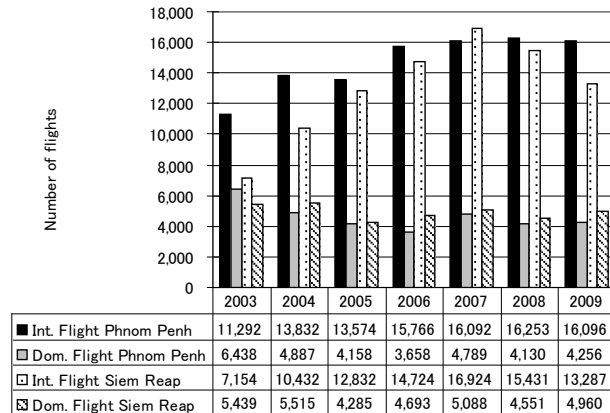

Source: SSCA.

Figure 5-3: Number of flights

Domestic flight passengers have been significantly decreasing since 2005.

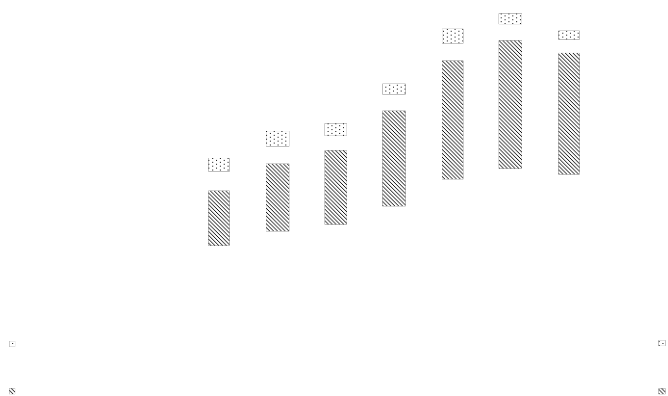

Source: SSCA

Figure 5-4: Number of passengers (Phnom Penh)

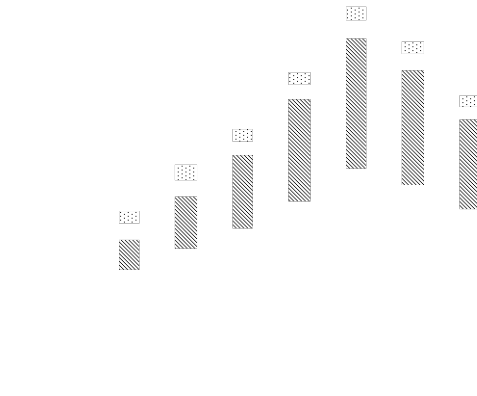

Figure 5-5: Number of passengers (Siem Reap)

At Siem Reap International Airport, the number of international flight passengers has been rapidly increasing in the last 5 years. In 2007, it accommodated the largest number of passengers of all airports in Cambodia, exceeding even Phnom Penh International Airport. However, both in 2008 and in 2009, Siem Reap International Airport was surpassed by Phnom Penh International Airport, in terms of number of passengers. Also, like Phnom Penh International Airport, the number of domestic flight passengers has been decreasing.

5.5. Airport Development Plan

The following were projects that had been carried out by the SSCA in 2009.

Table 5-5: Projects that had been carried out by the SSCA in 2009

Phnom Penh International Airport	Siem Reap International Airport
<ul style="list-style-type: none"> ○ Escalator including civil works ○ Extend GH roof (1400m²) ○ Extend Cargo export storage (2000m²) ○ Extend Maintenance storage(200m²) ○ Renovation of cargo, custom cam and forwarders offices, for offices, lockers, archives rooms and stores. ○ Helistation ○ Drainage improvement (7300ml) 	<ul style="list-style-type: none"> ○ New VIP building (400 m²) ○ New hangars and offices for GH (1500m²) ○ Workshop for MTN (600 m²) ○ Airport fire fighting additional water tank ○ Widening of the shoulders all along the runway ○ Widening of taxiway A ○ Car park improvement ○ Drainage and Canal rehabilitation ○ Shop: 100m² extension terrace ○ Current terrace transformed in shop
Sihanouk Ville International Airport	
<ul style="list-style-type: none"> ○ Service and access roads ○ Fencing for the new bought areas + former fence to be removed 	

Source: DAFIF & SSCA

In collaboration between MPWT and SSCA, the following activities are to be carried out in 2010:

- New CNS/ATM (Master Plan Study on Communication, Navigation and Surveillance/Air Traffic Management System)
- Collect airport condition information at: Kep, Kampot, Kampong Chhnang, Porsat, Banteay Meanchey, Oddar Meanchey, Rattanakiri, Kampong Thom, Stung Treng, Preah Vihear, Mondulkiri, Kraties, Kampong Cham, Battambang, Pailin, Koh Kong and Svay Rieng.

Supported by:

